

Users Guide

For Dynomation6
and DynoSim6

On Windows 7, 8 & 10

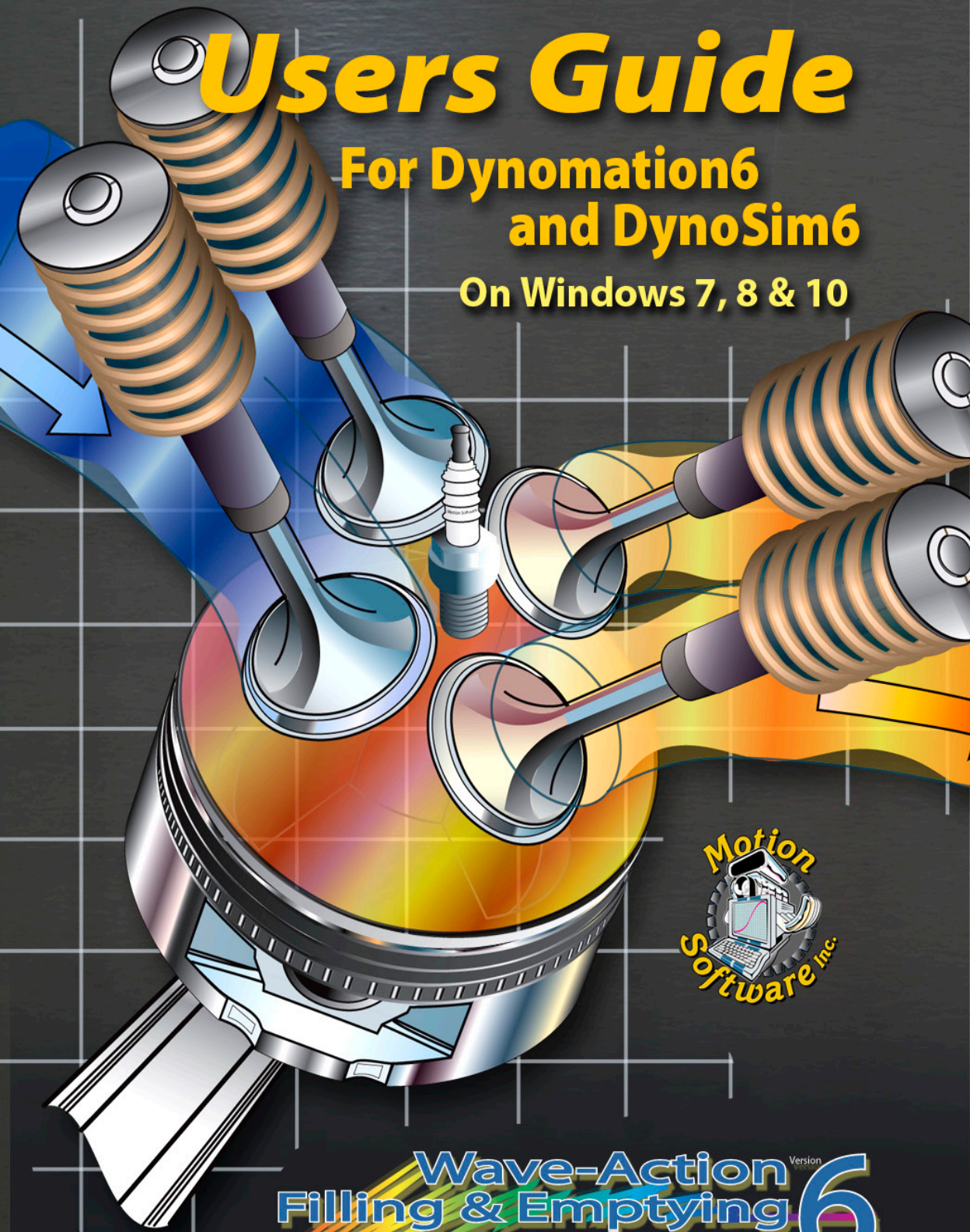

Wave-Action Version 6
Filling & Emptying Simulations

Dynomation6™ and DynoSim6™ Engine Simulations

MOTION SOFTWARE, INC. SOFTWARE LICENSE

PLEASE READ THIS LICENSE CAREFULLY BEFORE BREAKING THE SEAL ON THE DISKETTE ENVELOPE AND USING THE SOFTWARE. BY BREAKING THE SEAL ON THE DISKETTE ENVELOPE, YOU ARE AGREEING TO BE BOUND BY THE TERMS OF THIS LICENSE. IF YOU DO NOT AGREE TO THE TERMS OF THIS LICENSE, PROMPTLY RETURN THE SOFTWARE PACKAGE, COMPLETE, WITH THE SEAL ON THE DISKETTE ENVELOPE UNBROKEN, TO THE PLACE WHERE YOU OBTAINED IT AND YOUR MONEY WILL BE REFUNDED. IF THE PLACE OF PURCHASE WILL NOT REFUND YOUR MONEY, RETURN THE ENTIRE UNUSED SOFTWARE PACKAGE, ALONG WITH YOUR PURCHASE RECEIPT, TO MOTION SOFTWARE, INC., AT THE ADDRESS AT THE END OF THIS AGREEMENT. MOTION SOFTWARE WILL REFUND YOUR PURCHASE PRICE WITHIN 60 DAYS. NO REFUNDS WILL BE GIVEN IF THE PACKAGING HAS BEEN OPENED.

Use of this package is governed by the following terms:

1. License. The application, demonstration, and other software accompanying this License, whether on disk or on any other media (the "Motion Software, Inc. Software"), and the related documentation are licensed to you by Motion Software, Inc. You own the disk on which the Motion Software, Inc. Software are recorded but Motion Software, Inc. and/or Motion Software, Inc.'s Licensor(s) retain title to the Motion Software, Inc. Software, and related documentation. This License allows you to use the Motion Software, Inc. Software on a single computer and make one copy of the Motion Software, Inc. Software in machine-readable form for backup purposes only. You must reproduce on such copy the Motion Software, Inc. Copyright notice and any other proprietary legends that were on the original copy of the Motion Software, Inc. Software. You may also transfer all your license rights in the Motion Software, Inc. Software, the backup copy of the Motion Software, Inc. Software, the related documentation and a copy of this License to another party, provided the other party reads and agrees to accept the terms and conditions of this License.
2. Restrictions. The Motion Software, Inc. Software contains copyrighted material, trade secrets, and other proprietary material, and in order to protect them you may not decompile, reverse engineer, disassemble or otherwise reduce the Motion Software, Inc. Software to a human-perceivable form. You may not modify, network, rent, lease, loan, distribute, or create derivative works based upon the Motion Software, Inc. Software in whole or in part. You may not electronically transmit the Motion Software, Inc. Software from one computer to another or over a network.
3. Termination. This License is effective until terminated. You may terminate this License at any time by destroying the Motion Software, Inc. Software, related documentation, and all copies thereof. This License will terminate immediately without notice from Motion Software, Inc. If you fail to comply with any provision of this License. Upon termination you must destroy the Motion Software, Inc. Software, related documentation, and all copies thereof.
4. Export Law Assurances. You agree and certify that neither the Motion Software, Inc. Software nor any other technical data received from Motion Software, Inc., nor the direct product thereof, will be exported outside the United States except as authorized and permitted by United States Export Administration Act and any other laws and regulations of the United States.
5. Limited Warranty on Media. Motion Software, Inc. warrants the disks on which the Motion Software, Inc. Software are recorded to be free from defects in materials and workmanship under normal use for a period of ninety (90) days from the date of purchase as evidenced by a copy of the purchase receipt. Motion Software, Inc.'s entire liability and your exclusive remedy will be replacement of the disk not meeting Motion Software, Inc.'s limited warranty and which is returned to Motion Software, Inc. or a Motion Software, Inc. authorized representative with a copy of the purchase receipt. Motion Software, Inc. will have no responsibility to replace a disk damaged by accident, abuse or misapplication. If after this period, the disk fails to function or becomes damaged, you may obtain a replacement by returning the original disk, a copy of the purchase receipt, and a check or money order for \$10.00 postage and handling charge to Motion Software, Inc. (address is at the bottom of this agreement).
6. Disclaimer of Warranty on Motion Software, Inc. Software. You expressly acknowledge and agree that use of the Motion Software, Inc. Software is at

your sole risk. The Motion Software, Inc. Software and related documentation are provided "AS IS" and without warranty of any kind, and Motion Software, Inc. and Motion Software, Inc.'s Licensor(s) (for the purposes of provisions 6 and 7, Motion Software, Inc. and Motion Software, Inc.'s Licensor(s) shall be collectively referred to as "Motion Software, Inc.") EXPRESSLY DISCLAIM ALL WARRANTIES, EXPRESS OR IMPLIED, INCLUDING, BUT NOT LIMITED TO, THE IMPLIED WARRANTIES OF MERCHANTABILITY AND FITNESS FOR A PARTICULAR PURPOSE. Motion Software, Inc. DOES NOT WARRANT THAT THE FUNCTIONS CONTAINED IN THE Motion Software, Inc. SOFTWARE WILL MEET YOUR REQUIREMENTS, OR THAT THE OPERATION OF THE Motion Software, Inc. SOFTWARE WILL BE UNINTERRUPTED OR ERROR-FREE, OR THAT DEFECTS IN THE Motion Software, Inc. SOFTWARE WILL BE CORRECTED. FURTHERMORE, Motion Software, Inc. DOES NOT WARRANT OR MAKE ANY PRESENTATIONS REGARDING THE USE OR THE RESULTS OF THE USE OF THE Motion Software, Inc. SOFTWARE OR RELATED DOCUMENTATION IN TERMS OF THEIR CORRECTNESS, ACCURACY, RELIABILITY, OR OTHERWISE. NO ORAL OR WRITTEN INFORMATION OR ADVICE GIVEN BY Motion Software, Inc. OR A Motion Software, Inc. AUTHORIZED REPRESENTATIVE SHALL CREATE A WARRANTY OR IN ANY WAY INCREASE THE SCOPE OF THIS WARRANTY. SHOULD THE Motion Software, Inc. SOFTWARE PROVE DEFECTIVE, YOU (AND NOT Motion Software, Inc. OR A Motion Software, Inc. AUTHORIZED REPRESENTATIVE) ASSUME THE ENTIRE COST OF ALL NECESSARY SERVICING, REPAIR, OR CORRECTION. SOME JURISDICTIONS DO NOT ALLOW THE EXCLUSION OF IMPLIED WARRANTIES, SO THE ABOVE EXCLUSION MAY NOT APPLY TO YOU.

7. Limitation of Liability. UNDER NO CIRCUMSTANCES INCLUDING NEGLIGENCE, SHALL Motion Software, Inc. BE LIABLE FOR ANY INCIDENT, SPECIAL, OR CONSEQUENTIAL DAMAGES THAT RESULT FROM THE USE, OR INABILITY TO USE, THE Motion Software, Inc. SOFTWARE OR RELATED DOCUMENTATION, EVEN IF Motion Software, Inc. OR A Motion Software, Inc. AUTHORIZED REPRESENTATIVE HAS BEEN ADVISED OF THE POSSIBILITY OF SUCH DAMAGES. SOME JURISDICTIONS DO NOT ALLOW THE LIMITATION OR EXCLUSION OF LIABILITY FOR INCIDENTAL OR CONSEQUENTIAL DAMAGES SO THE ABOVE LIMITATION OR EXCLUSION MAY NOT APPLY TO YOU.

In no event shall Motion Software, Inc.'s total liability to you for all damages, losses, and causes of action (whether in contract, tort (including negligence) or otherwise) exceed the amount paid by you for the Motion Software, Inc. Software.

8. Controlling Law and Severability. This License shall be governed by and construed in accordance with the laws of the United States and the State of California. If for any reason a court of competent jurisdiction finds any provision of this License, or portion thereof, to be unenforceable, that provision of the License shall be enforced to the maximum extent permissible so as to effect the intent of the parties, and the remainder of this License shall continue in full force and effect.

9. Complete Agreement. This License constitutes the entire agreement between the parties with respect to the use of the Motion Software, Inc. Software and related documentation, and supersedes all prior or contemporaneous understandings or agreements, written or oral. No amendment to or modification of this License will be binding unless in writing and signed by a duly authorized representative of Motion Software, Inc.

Motion Software, Inc.
222 South Raspberry Lane
Anaheim, CA 92808

© 1995, 2018 to present By Motion Software, Inc. All rights reserved by Motion Software, Inc. MS-DOS, Windows, and Windows95/98/Me/NT/2000/XP/Vista and Windows 7, 8 and 10 are trademarks of Microsoft Corporation. IBM is a trademark of the International Business Machines Corp. Dynomation™, Dynomation6™, DynoSim6™, and Motion Software™ are trademarks of Motion Software, Inc. All other trademarks, logos, or graphics are the property of their respective owners.

ACKNOWLEDGMENTS, ETC.

ACKNOWLEDGMENTS: Larry Atherton of Motion Software wishes to thank the many individuals who contributed to the development of this program:

Brent Erickson, Programmer—Simulation Designer, Windows, C, C++, Assembler Programmer, and avid automotive enthusiast! Brent's positive "can-do" attitude is backed up by his ability to accomplish what many dismiss as impossible. Thanks so much, Brent!

Our Beta Testers And Dedicated Dynomation Enthusiasts—There are many individuals that regularly use Dynomation that have graciously given their time to provide suggestions, test new features, and help our development team. Many of these individuals have treated Dynomation6 as if it was their own, truly caring about making it the best simulation possible. To these dedicated enthusiasts, many of which run their own companies and have limited time to give, we offer our sincerest thanks. We could not have done it without you!

Here is just a few of the talented people that helped us with this software project:

Chuck Palmgren & Dan Gurney
John Aller
Rod & Ronnel Badertscher
Rick Hanneman
Ted James
Steve Jennings
Doug Macmillan
Michael Marriott
Bob Mullen
Mike Norman
Dave Propst
Trinity Simpson
Audie Thomas

Many additional individuals have assisted us in beta testing and have helped us improve and extend our simulation software.

Larry Atherton, Pres., CEO
Motion Software, Inc.

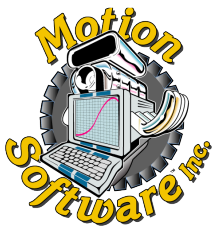

This publication is the copyright property of Motion Software, Inc., Copyright © 1995, 2018 to present by Motion Software, Inc. All rights reserved. All text and photographs in this publication are the copyright property of Motion Software, Inc. It is unlawful to reproduce—or copy in any way—resell, or redistribute this information without the expressed written permission of Motion Software, Inc. This PDF document may be downloaded by anyone for informational and educational use only. No other uses are permitted.

The text, photographs, drawings, and other artwork (hereafter referred to as information) contained in this publication is provided without any warranty as to its usability or performance. Specific system configurations and the applicability of described procedures both in software and in real-world conditions—and the qualifications of individual readers—are beyond the control of the publisher, therefore the publisher disclaims all liability, either expressed or implied, for use of the information in this publication. All risk for its use is entirely assumed by the purchaser/user. In no event shall Motion Software, Inc., be liable for any indirect, special, or consequential damages, including but not limited to personal injury or any other damages, arising out of the use or misuse of any information in this publication or out of the software that it describes. This manual is an independent publication of Motion Software, Inc. All trademarks are the registered property of the trademark holders.

The publisher (Motion Software, Inc.) reserves the right to revise this publication or change its content from time to time without obligation to notify any persons of such revisions or changes.

CONTENTS

MOTION SOFTWARE LICENSE.....	2	Tools Menu	26
ACKNOWLEDGMENTS	3	Window Menu.....	26
INTRODUCTION	10	Help Menu	26
What Are DynoSim6 and Dynomation6?	11	Tool Bar	26
How Dynomation6 and DynoSim6 Work	12	Simulation Category	26
What's New In Version6	13	Engine Component Categories	27
Program Requirements	14	Short Block	27
Additional Requirements	15	Cylinder Heads.....	27
INSTALLATION	18	Induction.....	27
Program Installation Steps	18	Camshaft.....	27
Post Program Installation Setup	20	Combustion	27
Installing The USB Security Device.....	20	Exhaust	27
Solving USB Key Issues.....	20	Notes	27
Installing The CamDisk 10-Point Library	21	Program Screen Panes & Display Tabs	28
Installing A Lobe-Profile Library	21	Engine Selection Tabs	28
Starting The Simulation For The First Time ..	21	Range Limit Line.....	29
Registering Your Software	22	QuickAccess™ Buttons	29
Automatic Program Updates	22	Vertical Screen Divider	29
Un-installing This Simulation	22	Simulation Progress Indicator.....	29
Solving Installation Related Problems	23	Crank-Angle SimData™ Window	29
Tech Support Contact Info	23	Port Velocity Graph.....	30
PROGRAM OVERVIEW	24	Port Pressures Graph.....	30
Main Program Screen.....	24	Graph Options & Properties	30
Title Bar	24	Horsepower/Torque Graph	31
Program Menu Bar	24	Graph Reticule Line.....	31
File Menu.....	25	Window Size Buttons.....	32
Edit Menu	25	Pop-Up DirectClick™ Menus.....	32
View Menu.....	25	Direct-Input vs Menu Input	33
Simulation Menu.....	25	Keyboard Selection And Shortcuts	33
Units Menu	26	Cursor Keys Move Reticule Lines	33
		Menu-Bar Menus.....	33
		Moving Through Component Fields	34
		Entering Data In Component Fields	34
		The Meaning Of Screen Colors	34

CONTENTS

White	35	Valve Diameters & Basic Flow Theory	60
Light Blue (Cyan).....	35	Domestic Head Selections	62
Light Gray.....	35	2-Valve, Low-Performance.....	62
FIVE-MINUTE TUTORIAL	36	2-Valve , Wedge.....	64
Building An Engine With FE & WA.....	36	2-Valve, Hemi/Canted	65
Getting Started/Building From Scratch	36	4-Valve Hemi/Canted	65
Simulation Setup	36	Sport-Compact Head Selections.....	67
Selecting A Shortblock.....	37	4-Valve, Pentroof.....	68
Selecting Cylinder Heads.....	38	2-Valve, Pentroof, Stock.....	69
Induction Selections	39	Custom Port Flow.....	70
Camshaft, Combustion, Exhaust.....	39	Valve-Per-Port And Diameter Menus	71
Creating A QuickCompare™ Baseline	40	Test Valve Diameters.....	73
Changing Cams & Exhaust	41	Running Diameters And Auto Calc.	73
Trying Manifolds, Cylinderheads, etc.	42	Alternate Valve-Flow Calc Methods.	74
Switching To Wave-Action Model	43	When To Apply Alternate Methods.	76
Completing Component Selections	43	Induction Category	78
Tuning Intake Port Area.....	45	Intake Manifold Design.....	78
Tuning Intake Runner Length.....	46	Baseline Manifold Models	80
Tuning Exhaust System Specs	46	Domestic Plenum Manifolds.....	80
Building Tri-Y Headers	47	Dual-Plane Manifolds	80
Comparison Testing.....	48	Dual-Plane Theory	80
Creating A ProPrint™ Report	48	Single-Plane Manifolds	83
THE ENGINE COMPONENT MENUS	50	Single-Plane Theory.....	83
Simulation Component Category	50	Tunnel-Ram Manifolds	85
Overview Of FE And WA Sim Models.....	50	LS1/LS6 Composite Manifolds.....	86
Which Simulation Model To Choose	51	Direct Port Injection HP Manifolds	88
Simulation Convergence & “Cycles”	52	Sport-Compact Plenum Manifolds.....	88
Wave-Action Simulation “Meshing”	53	Non-Tuned Manifolds	89
RPM Ranges and Atmospheric.....	54	Long-Tubing Runner Manifolds.....	90
Shortblock Component Category	56	Tuned-Runner Manifolds.....	90
Rod Ratio, Length, Pin Offset.....	57	Honda Type Manifolds	93
Cylinder Head Component Category	60	Individual-Runner Manifolds.....	95
		Individual Runner For Carbs	97
		Runner Wall Temperature	98

CONTENTS

Airflow And Pressure Drop Selection.....	98	10-Point And Profile Cam Data.....	126
Airflow-Rate Assumptions	99	Best Of Both Worlds.....	128
Wave-Action Intake Runner Specs.....	100	10-Point Camshaft Menu Choices.....	129
Runner Length.....	100	2- & 4-Valve Non-V-V-T Cams.....	129
Port Entry Area	100	2- & 4-Valve V-V-T Cams	134
Minimum Port Area.....	101	V-V-T Activation & Modeling	139
Plenum Volume	102	Lobe Lift, Rocker Ratio, Lash	139
Taper Angle	102	Using The Net (Sim) Valve-Lift Menu	141
Elliptical Bellmouth Runners.....	103	Rocker-Math Calculator (Introduction).....	142
Forced-Induction Specifications	104	Lifter/Valve Acceleration	142
Flow Restriction Location	105	Using The 10-Point CamManager™	146
Turbine Size	105	Variable Valve Timing Group	148
Turbine Housing A/R Ratio.....	106	Cam Description Group.....	148
Number Of Turbos.....	107	Extended Application Info.....	149
Boost Limit.....	108	Camshaft Timing Diagram.....	149
Belt Ratio.....	108	Estimated Lifter Acceleration.....	150
Internal Gear Ratio	108	Tabbed Data Pages.....	151
Operational Indicators	108	Camshaft Specs Tabbed Page.....	151
Surge	109	Event Timing Tabbed Page	152
Choke.....	109	Search For CamFiles Tabbed Page. 152	
Overspeed	110	CamManager Buttons	153
Selecting The Best Supercharger	110	Loading 10-Point Camfiles	153
Selecting Turbochargers	110	Opening .DCM, .SCM, .CAM	153
Selecting Centrifugals	112	Saving CamFiles.....	154
Belt-Ratio Calculations	112	Importing And Using Lobe-Profile Files	156
Selecting Roots/Screw	113	CamPro and CamProPlus (CPP)	156
Intercoolers.....	115	CamDoctor	157
CamShaft Category	118	S96 ASCII Files	157
Introduction.....	121	.ECP COMP Lobe Profile Files	158
Quick Overview	105	Importing Lobe Profiles	158
Cam Basics	108	Lobe Source-Data List	159
Valve Events.....	122	Description	159
Seat-To-Seat Valve Timing.....	123	Lobe Lift And Duration	159
0.050-Inch Lobe Timing	125	Lobe-Profile Rendering/Base Circle. 160	

CONTENTS

Lobe-Data Destination	160	Primary, Secondary, Tertiary.....	192
Convert To 10-Point	161	Primary, Secondary Collector.....	193
Lobe Centerline.....	161	Megaphone And Exit Diameter... 193	
Lobe Lift And Acceleration Graph	161	Real-World Examples/WA Designs ..	194
Tuning And Modifying Profile Data	162	4-to-1 Header	194
Advance/Retard Cam Timing	164	Add A Primary Step	196
Adv/Ret For Single-Cam Engine.....	164	Tri-Y Header Buildup	196
Adv/Ret For Dual-Cam Engine.....	166		
Combustion Category	168	SIMULATION RESULTS DISPLAYS	198
About Compression Ratio	169	Main Results Graphs	198
Bore, Stroke, And Compression.....	171	Graph Reticule Lines.....	199
Compression Ratio Calculator	173	Graph Underlying Component.....	200
Piston/Chamber Thermal Coatings	173	DataSim™ Window	200
Fuel Selection.....	173	Vertical And Horizontal Dividers	202
Nitrous-Oxide Injection.....	175	Graph Options Menu	202
Combustion Chamber Selection.....	178	Axis Data	202
Ignition Timing	180	Axis Scaling.....	202
		Optimize Y1/Y2 Scaling.....	203
		QuickCompare™	204
Exhaust Category	184	Graph Properties Dialog.....	205
Filling-And-Emptying Selections.....	184	Graph Data Tab	205
Stock Manifolds/Mufflers.....	185	Axis Properties Tab	206
HP Manifolds/Mufflers.....	186	DataZones™ Tab	206
Small Headers W/Mufflers	187	Reset All Button.....	207
Small Headers Open Exhaust.....	187	Exact Value Tables	208
Small Flow Optimized Headers.....	188	3D Engine Pressure/Flow Display	208
Small Tri-Y Headers Open Exhaust .	188	Intake Port Color Intensity.....	209
Large Header Selections	188	Exhaust Port Color Intensity.....	209
Large Stepped Headers.....	188	Intake Port Flow Arrow	209
Filling-And-Emptying Tune RPM.....	189	Exhaust Port Flow Arrow	210
Wave-Action Exhaust Selections	190	Gray Arrows.....	210
Header Design	191	Mass Flow Arrows	210
Minimum Port Area.....	192	Crank Position Indicator	211
Pipes Per Cylinder.....	192	Display Only Wireframe.....	211

CONTENTS

Display Exterior Engine Outline.....	211	Burette-Measured Mode	241
Display Color Engine Cycle.....	211	PRINTING	244
THE Quick-Iterator™	212	ProPrinting™ Dyno Data/Power Curves.....	244
Using The Quick Iterator™	213	ProPrint™ Function & Setup	223
THE Pro-Iterator™	216	ProPrint™ Menu Choice	245
Using The ProIterator™	216	ProPrint™ Preview.....	246
Iterator Status Group.....	217	ProPrint™ Setup	246
Current Test Group.....	217	Printout Customizing	247
QuickStart™ Presets Group.....	218	Printout Page Descriptions.....	247
Cam-Timing Tabbed Page.....	219	Report Modification (Advanced).....	249
Induction Tabbed Page.....	219	SIMULATION ASSUMPTIONS	250
Bore/Stroke Tabbed Page	220	General Simulation Assumptions.....	250
Optimize For Tabbed Page.....	221	Fuel	250
Run/Results Tabbed Page.....	222	Environment	251
Close/Save State Button	224	Methodology.....	251
Close/Quit Button	224	Camshaft Modeling	251
Reset All Button.....	224	Air/Fuel Ratio Modeling	251
ProIterator™ Testing Walkthrough.....	224	Forced-Induction Modeling.....	253
Tips For Effective Iterative Testing.....	227	Roots & Screw Superchargers.....	253
VERSION-6 BUILT-IN CALCULATORS	230	Centrifugal Superchargers	254
Induction-Flow Calculator	230	Turbo Superchargers	255
Airflow Pressure-Drop Converter.....	232	Intercoolers	256
Mode 1, Any Flow To 1.5-In/Hg	232	Simulation Engine File Compatibility	257
Mode 2, Any Flow To 3.0-In/Hg	233	Dynomation6 & DynoSim6 Features	258
Mode 3, Any Flow To Any Pres Drop.....	233	WAVE-DYNAMICS ANALYSIS	263
Rocker-Math Calculator.....	234	The IC Engine: Unsteady Flow Machine	263
CamMath QuickCalculator™	236	Acoustic Waves Vs. Finite Waves	264
Compression Ratio Calculator.....	238	Compression & Expansion Waves	265
Using Known Volumes	239	Pressure Waves & Engine Tuning.....	268
Known Volumes Mode	239	Pressure-Time Histories	269
Using Measured Volumes	241	Gas Flow Vs. Engine Pressures.....	272

CONTENTS

Intake Tuning	273
Induction Runner Taper Angles	276
Port Flow Velocities	277
Exhaust Tuning	280
Exhaust Flow Velocities	283
Exhaust Tubing Lengths	283
Valve-Events And Tuning Strategies	286
IVO (Intake Valve Opening)	286
EVC (Exhaust Valve Closing)	287
EVO (Exhaust Valve Opening)	288
IVC (Intake Valve Closing)	289
Using Pressure Diagrams	289
The Pressure-Crank-Angle Diagram	289
The Pressure-Volume Diagram	291
Optimizing Valve Events	293
FREQUENTLY ASKED QUESTIONS	296
General Troubleshooting	296
Installation /Basic Operation	297
Screen Display	298
Bore, Stroke, Shortblock	299
Induction, Manifolds, Fuel	299
Camshaft/Valvetrain	299
Compression Ratio	301
Running A Simulation	301
MINI GLOSSARY	304
DYNO TEST NOTES	311

Wave-Action Filling & Emptying Simulations ^{Version} 6

INTRODUCTION

Note: *If you can't wait to start using this engine simulation, feel free to jump ahead to **INSTALLATION** (or review the 16-page QuickStart Guide supplied with your software), but don't forget to review this manual when you have time. Also, please complete the **Registration Form** that appears when you first start your software. It entitles you to receive tech support, obtain free automatic releases and more. Also, if you change your mailing address or email anytime in the future, please update your registration information by re-selecting **Registration** from the **HELP** menu.*

Thank you for purchasing Dynomation6™ or DynoSim6™ for Windows from Motion Software, Inc. This software is the result of many years of simulation development and programming effort that includes program optimizations developed from over twenty years of on-going user feedback. This simulation was built, from the ground up, to be easy-to-use, yet it is fully capable of advanced engine-simulation analysis that can reveal WHY the IC (Internal Combustion) engine functions as it does. You can view pressure waves and mass flow that take place inside the intake and exhaust passages. You can easily change components and measure their affect on these pressure waves and on engine power. And you can learn more about how engines work than you ever thought possible. Not only that, we are confident that you will find this simulation to be an intuitive, easy-to-use program that makes engine testing and analysis simple and fun! By eliminating the frustration that is common with many engineering-oriented simulations (or the huge expense involved in long dyno-test sessions), you are free to

Dynomation6™ (the full Wave-Action version of this simulation) is the most comprehensive yet easy-to-use engine simulation software package ever offered to performance engine builders and enthusiasts. Dynomation6 provides high speed, accuracy and a robust modeling toolset.

Part No. DYM6 www.MotionSoftware.com

DYNAMINATION6™

PROFESSIONAL

Easy-To-Use Wave-Action Engine Simulation

Includes Powerful Simulation Features:

- View Intake & Exhaust Pressure Waves
- Advanced Camshaft & Lobe Modeling
- Fitter™ Code Guarantees Accuracy
- Detailed Forced-Induction Modeling
- Diesel Modeling, Iterator™ Testing
- And Much More!

Explore and optimize intake and exhaust flow inside a running engine!

Used By Professional Engine Builders and Race Teams Worldwide

Introduction To Version6 Simulations

Main Program Screen

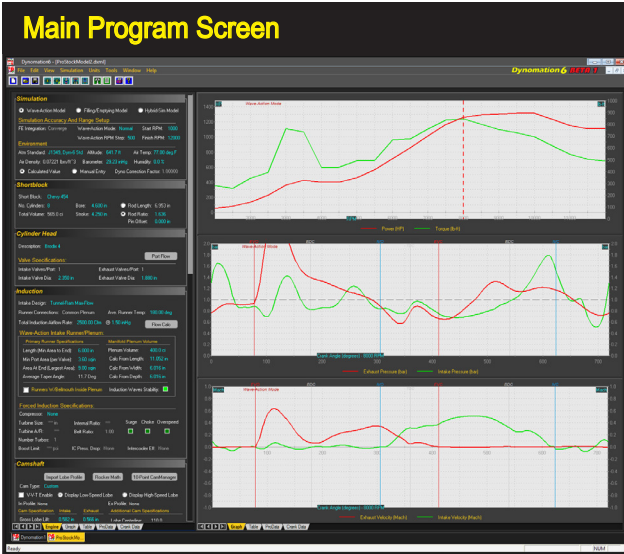

The simulation incorporates a completely unique, intuitive user interface (shown using one of several program color schemes). If you wish to change an engine component, simply click on any component field on the left side of the screen and select a new specification from the drop-down list or enter custom values. Engine components are shared between both the Filling-And-Emptying (FE) and Wave-Action (WA) simulation models. Results can be displayed in a wide variety of tables and graphs.

“play,” using your imagination to uncover power secrets for single or multiple-cylinder, four-stroke engines for automotive, racing, or a myriad of other applications.

What Are DynoSim6 and Dynomation6?

At the core of Dynomation6 and DynoSim6 is are mathematical models that simulations four-stroke, internal combustion (IC) engines. These simulations incorporate two distinct simulation methods: 1) A *Filling-And-Emptying* (FE) method, used in both DynoSim6 and Dynomation6 simulations, that provides fast mathematical solutions to engine physics, including flow analysis through intake- and exhaust systems, making this technique a powerful and efficient way to optimize engine designs, and 2) A full *Wave-Action* (WA) method used in Dynomation6 that calculates and predicts the complex pressure-wave dynamics and particle flows in intake and exhaust passages. The *Wave-*

DynoSim6™ uses the FE (Filling-and-Emptying) simulation method and incorporates many features of Dynomation6, including ease of use, fast calculation times and exceptional accuracy. Plus the full toolset provided with Dynomation6 is included in this powerful simulation package.

Introduction To Version6 Simulations

Action model picks up where the *Filling-And-Emptying* method leaves off and “homes in” on the best port sizes and shapes, runner lengths, header configuration and tubing sizes, cam timing and valve motion, and other engine parameters, providing unprecedented accuracy for the serious engine designer and builder.

Both DynoSim6 and Dynomation6 use a carefully-crafted *Direct-Click™* user interface that lets you select parts with a single mouse click. Multiple graphs and tables display power, torque, engine pressures and many other engine variables both independently and in comparison views. Dynomation6 also includes a *HybridSim™* display, where simulation results from both simulation methods are combined, building on the strengths of each modeling technology.

You'll also find hundreds of other features that have become Motion Software's trademarks, including: 1) rapid *Iterative™* testing, 2) comprehensive camshaft, cylinder-head-flow, and engine-file imports, 3) built-in calculators for compression ratio, airflow conversion, rocker-arm and cam-timing math, 4) side-by-side graph *QuickComparisons™*, 5) professional multi-page *ProPrint™* dyno-test reports, and much more. We are confident that you will find Dynomation6/DynoSim6 to be the most capable engine simulation software packages available for engine professionals and serious enthusiasts.

How Dynomation6 And DynoSim6 Work

Dynomation6 and DynoSim6 are Windows 7, 8 and 10, 32- and 64-bit, engine-dynamometer simulations that utilize a *full-cycle* analysis, meaning that they calculate the complete fluid-dynamic, thermodynamic, wave-dynamic, and frictional conditions that exist inside each cylinder throughout the entire 720 degrees of the four-cycle process.

Many other simulation programs simply calculate the volumetric efficiency (VE) and then derive an estimate of torque and horsepower. There are many shortcomings to this and similar techniques. The two greatest drawbacks are: 1) since cylinder pressure is not precisely determined, it is impossible to predict the pressure on the

Iterative Testing™ is a powerful feature included in both the ***Filling-And-Emptying*** and ***Wave-Action*** models. This screen illustrates a test evaluating a series of components (over 200 dyno tests have been performed). Using this powerful tool it is possible to automatically run thousands or even hundreds of thousands of tests to find the best combinations. The simulation keeps track of all the results and displays the best matches to your test criterion.

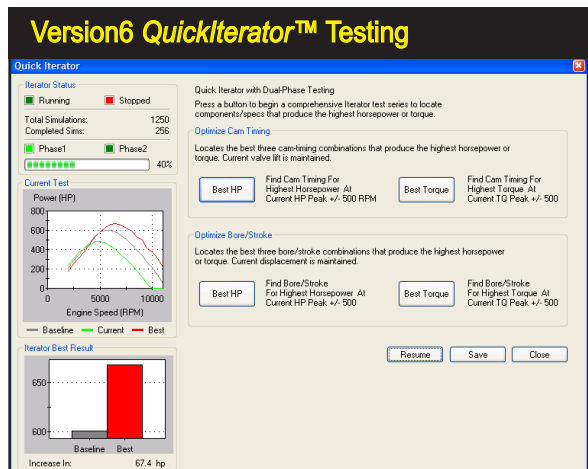

Introduction To Version6 Simulations

exhaust valve and the subsequent mass flow through the port when the exhaust valve opens, and 2) the inability to accurately determine the percentage of pumping horsepower (energy needed to move gasses into and out of the engine) from the predicted horsepower.

Since Version6 incorporates full-cycle models that include frictional, charge flow, and pumping-loss calculations, extensive computation is required for each power point. In fact, the simulations perform several HUNDRED MILLION calculations at each rpm point throughout the rpm range selected for the test. This level of mathematical analysis is only possible with modern computers and their built-in, high-speed math-computation capabilities.

Please Note: *The Wave-Action (Dynomation) model is more computationally intensive than the Filling-And-Emptying (DynoSim) model. As a result, you may experience simulation times of several seconds or more for each Wave-Action analysis to be completed (depends on the speed of your computer system, the rpm range for the simulation, and other simulation specific settings).*

The in-depth analysis provided by version6 simulations offer unprecedented accuracy over a vast range of engine designs. Both DynoSim6 and Dynomation6 have been successfully used to model single-cylinder “lawn-mower” engines, light aircraft engines, automotive engines, 2-, 3-, 4-, and 5-valves-per-cylinder, high-performance racing engines, ProStock drag-racing powerplants, multi-thousand horsepower supercharged, nitrous-oxide injected “mountain motors,” and many other engine designs.

WHAT'S NEW IN Version6

If you have used earlier versions of our simulations, you will find version-6 packages offer a significant upgrade. During the development cycle, many aspects of the program have been improved, including cam-timing and lift-curve modeling with the use of all-new *Fitter* routines, enhanced user interface functionality, new graph and table results displays, more accurate forced-induction modeling with improved Compressor Map and Engine Demand Line displays, plus substantial improvements in exhaust-system modeling, particularly in Dynomation6. Here's a short list of some of the the new features and changes in version6 (for both the FE and WA methods, unless otherwise noted):

- Exhaust modeling in WA supports three primary sections (pipes), two collector sections, and a megaphone from which you can design any header system.
- Exhaust modeling in FE now includes steps, Tri-Ys, and more.
- “Fitter” math routines ensure optimum valve-motion accuracy.
- New fuels and Diesel modeling supported; CRs extended to 30:1.
- Improved Latent Heat Of Vaporization fuel modeling.
- Now includes intake runner-temperature modelling.
- WA "simulation cycle count" automatically determined; no input required.
- Pressure-Wave Stability indicators give at-a-glance warning of issues.

Introduction To Version6 Simulations

- WA Manifold-Plenum and Runner-Bellmouth modeling.
- FE displays pressure waves and particle flow velocities, just like WA!
- FE includes several additional exhaust models and tubing-size prediction.
- Iterator finds optimum Runner-Length and Runner-Areas.
- Improved Forced-Induction modeling and Turbo Map displays.
- Added feedback in the Simulation Log, helps diagnose simulation issues.
- Graph Coefficient of Discharge (CD) and Curtain Areas for all valves.
- Table displays Mass Flow, in Lb/min and Kg/sec, at each RPM step.
- Enter your own conversion factor for Brake-to-Wheel Horsepower.
- Improved Units handling for US and Metric, and a new Hybrid Units Model!
- And a lot more!

The display and analysis of pressure waves in the intake and exhaust ports also has been improved. Click on the power/torque graph to select any rpm point; you will instantly see the status of pressure waves and mass flow for that engine speed for both the WA and FE simulations. Drag the reticule line on the power/torque graph; the pressures and flow dynamics will be instantly updated as you scan through the rpm range. This capability provides an unprecedented view of pressure and particle flow within a “running” engine for both WA and FE simulations.

Enhancements were added to *Iterative Testing*[™], an exclusive feature of Motion Software simulations. *Iterative Testing* allows you to automatically perform thousands of dyno tests, keep track of all the results, and locate the best component combination that matches your search criterion. In addition to cam timing, intake manifolds, bore, and stroke, you can now *Iterate* intake runner lengths, and minimum and entry areas in the intake ports (for the WA simulation only).

Version6 also offers many additional improvements. Diesel modeling is now supported with compression ratios as high as 30.0:1. *Latent Heat of Vaporization* modelling has been enhanced to better simulate intake-charge temperatures, particularly with supercharges and racing fuels, like methanol. Manifold runner wall temperature can be modeled to directly support "air-gap" manifolds and other unique manifold/runner ambient conditions. Cam *Dynamic Stability Indicators* have been included to alert the user if the current cam timing values generates stability issues. Additional indicators in Dynomation6 located in the Induction and Exhaust categories show calculation issues in intake or exhaust pressure-wave analysis.

But most important is what hasn't changed: our top-tier tech support. The Motion Software, Inc., development staff will be available to help you if you run into issues that you can't solve on your own. We are very interested in helping you succeed with Version6 simulations. Let us know how we can help!

Program Requirements

Here are the basic hardware and software requirements:

- A Windows-compatible PC with a CD-ROM drive or access to an external CD drive.

Introduction To Version6 Simulations

- A USB Port for the Security Key for Dynomation6 only (see INSTALLATION for more information on program security). The USB Security Key supplied with your software is required to run Dynomation6 (not required for DynoSim6).
- A minimum of 2GB of RAM (random access memory) for Windows 7, 8 and 10. More memory than this will improve program performance.
- Windows 7, 8 or 10 (32- or 64-bit). *Note: Version6 software may run on earlier versions of Windows (such as XP and Vista), but these installations are not supported.*
- An Internet connection to obtain *Free* program updates (you will receive periodic updates, all free for registered users of version 6).
Note: Automatic updates over the Internet are not supported in Windows 2000.
- A video system capable of 1280 x 1024 or higher to optimize screen display of engine components and graphics.
- A fast system processor (2GHz or faster) will improve processing speeds; especially helpful for *Wave-Action* and *Iterative* testing. However, Version6 simulations will operate on any Windows qualified system, regardless of processor speed.
- A mouse/mousepad/trackball is required for cursor movement and component selection.
- Any Windows compatible printer (to obtain dyno-test printouts).
- You can export simulation data in a format that is readable by Microsoft Excel (spreadsheet). Excel (or a compatible product) is needed to utilize this feature.

Additional System Requirements And Considerations

Windows 7, 8 and 10: This software is fully compatible with Windows 7, 8 and 10 (either 32- or 64-bit versions). Make sure to install all the latest service packs and updates (use the Microsoft Windows Update feature available in the Start Menu, All Programs Menu, or visit www.microsoft.com to locate or activate automatic updates for your operating system; this is an automatic feature in Windows 10).

Windows 2000/XP/Vista: Our testing shows that Version6 simulations will usually operate on WindowsXP, Windows 2000, and Windows Vista. Make sure to install all the latest service packs and updates (use the Microsoft Windows Update feature available in the Start Menu, All Programs Menu, or visit www.microsoft.com to locate updates and service packs for your operating system).

Note-1: *Windows95 is not supported.*

Note-2: We recommend that you run this simulation on a Windows 7, 8 or 10 machine. These operating-system versions are the most sophisticated and reliable.

Video Graphics Card And Monitor: An 800 x 600 resolution monitor/video card is required to use version6 simulations. Systems with 1280 x 1024 (HD) resolution will

Introduction To Version6 Simulations

provide more screen “real estate,” and this additional display space is very helpful in component selection and power/pressure-curve analysis. Screens of 19-inches or larger with 1280 x 1024 resolution or higher are optimum for simulation testing.

System Processor: Version6 engine simulations, especially Dynomation6, are extremely calculation-intensive. Over 2 billion mathematical operations are performed for each complete power-curve simulation. While the program has been written to optimize speed, a faster processor will improve data analysis capabilities. Furthermore, our simulations incorporate powerful *Iterative Testing* that can perform an analysis of hundreds or thousands of simulation runs. To reduce calculation times and extend the modeling capabilities of the program, use the fastest processor possible.

Mouse: A mouse (trackball, or other cursor control device) is required to use this software. While many component selections can be performed with the keyboard, several operations within this simulation require the use of a mouse.

Printer: Dynomation6 and DynoSim6 can print a comprehensive *ProPrint*™ “Dyno-Test Report” of the simulated dyno engine on any Windows-compatible printer. If you use a color printer, the data curves and component information will print in color.



INSTALLATION

Note: In most cases, you can install Motion Software products simply by following on-screen prompts. As additional help, the following steps 1 through 8 provide information that will ensure a trouble-free installation. If you skip this part, we recommend all users review post-installation instructions later in this section:

- **Installation Overview:**

Dynomation6—As the purchaser/owner of Dynomation6, you are granted a license to install the simulation on as many computers as you wish, however, Dynomation will only startup and run on a computer that has the *USB Security Key* plugged into a USB port on your system (the USB Key is supplied in your software package).

DynoSim6—As the purchaser/owner of this DynoSim6, you are granted a license to install this simulation on two computers for your personal use. Installation on more systems, or “loaning” this software to friends, is a violation of the Motion Software License agreement.

- *Make sure all other applications are closed before you begin this installation.* The best way to do that is to restart your system, then begin this installation before you start any other programs. If other programs are using system resources during Dynomation installation, your computer may appear to “lock-up” when in fact, another application (“hiding” in the background) has taken focus away from the Dynomation installer.
- Make sure that you have sufficient memory to install/run this simulation (review system requirements in the previous chapter).

Note: *You must have Administrator Rights to properly install Dynomation under Windows 7, 8 and 10. Administrator Rights are also required to receive automatic updates over the Internet.*

Program Installation Steps

- 1) Close all other applications before you begin this installation.

Installing & Starting Version6 Simulations

2) Insert the simulation CD-ROM into your CD drive.

3) A Software Installation Menu will open on your Desktop within 5 to 30 seconds. Click the *Install* option.

Note: If the Software Installation Menu does not automatically appear on your

desktop within 30 to 60 seconds, view the contents of the install CD using *Windows Explorer* (not *Internet Explorer*) and double-click on *Dynomation6_InstallMenu.exe* or *DynoSim6_InstallMenu.exe* to begin program installation.



From the options provided in the Installation Menu, select *Install Dynomation6* or *DynoSim6*. If the Menu does not appear, see the **Note** in Step 3.

4) After you select an *Install*, allow up to two minutes for the program installer to read files from the CD and display an opening window. Click *Next* to view the Motion Software License Agreement. Read the Agreement and if you agree with the terms, click *I Accept....*, then click *Next* to continue the installation.

5) A Readme file is now displayed that includes information about installation and program updates. After you have reviewed the Readme, click *Next* to proceed with the installation.

6) **Important Note:** This software will be installed on its default path (on your boot drive, C:\, in the root). This location is essential to ensure that future updates install properly.

7) The installer *Start Installation* display gives you a chance to review the license agreement or readme info. Press *Install* to begin installation.

8) When the basic installation is complete, a *Setup Complete* dialog will be displayed. Click *Finish* to close the main installation window and start the installation of additional helper-software:

a) Dynomation6 only: The latest Sentinel-HASP USB Security Key driver will install next. This driver is required for Dynomation6 to communicate with the USB Security Key provided in your software package.

b) Next, a dialog box may appear and ask for permission to install Microsoft DirectX on your system (DirectX is required for 3D animations within the software). If you have the same or a newer version of DirectX already installed, the

Installing & Starting Version6 Simulations

installer will detect its presence and will not overwrite newer files.

c) After the DirectX installation, program installation is complete.

POST-INSTALLATION SETUP

Dynomation6 Only: Installing The USB Security Key

- 9) Plug the USB Security Key (the small USB device supplied with Dynomation6) into any available USB port on your computer. This key is licensed to you, the purchaser of this software, and will allow you to run Dynomation6 on any of your computer systems. You are licensed to install Dynomation6 on as many computers as you wish, however, Dynomation6 will only run on one system at a time; the computer with the Security Key installed.

Note: If you do not have an available USB port (your computer must have at least one free USB port to run Dynomation6), you can install a USB Card or Hub to extend the number of available USB ports. The Dynomation6 Security Key functions properly with most external USB Hubs.

Dynomation6 Only: Solving USB Security Key Issues

If Dynomation6 displays an error message that the Security Key (or HASP) is missing, here are some quick steps you can follow to isolate and correct this problem:

- a) Restart Windows after you install Dynomation6 to make sure the USB Key drivers are loaded and running.
- b) Make sure the Security Key is, in fact, properly connected to a functioning USB port on your computer or has been plugged in a USB hub that is connected to your computer. If you plugged the Key into a hub (rather than into a USB port on the computer), try connecting it directly to a port on your computer system.
Note: The Security Key contains a small red LED that illuminates when it is properly connected and communicating with its software drivers.
- c) Disconnect all other USB devices from your system, then reconnect the Dynomation6 Security Key (try a different port if possible).
- d) Try reinstalling the Security Key drivers by reinstalling Dynomation6 from the program CD (you do not need to un-install first), or install the latest driver posted on our Support page (www.motionsoftware.com/support.htm).
- e) If your computer is experiencing technical difficulties, such as non-functional

Installing & Starting Version6 Simulations

devices, spontaneous rebooting, numerous system messages, etc., the device drivers for the Security Key may not function properly on your system. You must have a stable computer system and a clean, virus-free Windows installation to properly use this simulation.

- f) As a “last resort,” try installing the simulation (and the Security Key) on a second computer system to determine if your original computer is at fault.

Installing A 10-Point CamDisk Library (Any Version)

- 10) CamDisks are additional libraries of 10-Point camfiles (much more information on 10-Point camfiles is provided later in this User Guide). If you wish to install a 10-point library (from a separate install CD or it can be included on the program installation CD), click the *Install* option on the Program Installation Menu.

Note-1: CamDisk camfiles can only be installed after the simulation has been successfully installed on your system.

Note-2: 10-Point camfiles are NOT the same as Lobe-Profile files; refer to the *Camshaft Category* later in this User Guide for more information on the differences between 10-Point valve timing and lobe-profile specifications.

Installing A Lobe-Profile Library

- 11) Motion Software offers libraries of cam-lobe profiles that allow version6 simulations to model exact valve motion and predict engine power with the highest accuracy. Lobe-Profile files consist of data that “maps” the entire shape of the lobe, not simply the valve opening, closing, and maximum lift points used in 10-Point Camfiles. If you wish to install a Lobe-Profile library, click on the Install option on the Program Installation Menu that will appear on your desktop after you insert the Profile CD into your CDRom drive.

Note: Profile Libraries can only be installed after a version6 simulation has been successfully installed on your system.

Starting The Simulation For The First Time

- 12) To start the simulation, double-click the *Dynomation6* or *DynoSim6* program icon that was installed on your Desktop. Alternatively, you can open the Windows START menu, select All Programs or Apps, then choose *Motion-Dynomation6 Engine Sim*, or *Motion-DynoSim6 Engine Sim* and click on the *software* icon displayed in that folder.

Dynomation6 Only: If Dynomation6 displays an error message indicating that the Security Key (HASP) is missing or cannot be found, refer to the information on the previous page (*Solving USB Security Key Issues*).

Installing & Starting Version6 Simulations

Registering Your Software

- 13) When you first start the simulation, a Registration dialog will be displayed. Please fill in the requested information, including your Serial Number found on the Quick-Start Guide provided in your software package. Then press the Register Now! button. If you have an Internet connection, your registration will be submitted to Motion Software, Inc. If you do not have an Internet connection, you will be presented with other registration options. If you do not register this simulation, you may not qualify for tech support or free updates.
- If you move or change your email address, you can update your registration information at any time simply by selecting *Registration* from the HELP menu. Keep up to date with the latest program advances by keeping your registration information current.

Automatic Program Updates

- 14) This simulation incorporates an automatic program updater that will keep your software current with the latest simulation developments. Before you put the simulation to work, make sure you allow the *Motion Updater* to check our servers and install the latest program updates (requires Internet connection). The Motion Updater will run automatically after program installation and then approximately every 30 days thereafter. You can check for a new update at any time by selecting *Check For Newer Version...* from the HELP menu within the simulation. If an automatic update was not installed properly, you can manually download the latest program update from our support page at: www.motionsoftware.com/support.htm.

Important: Don't assume you are running the latest software version if you just installed the software from the installation CD. CD's are NOT updated each time new releases are issued. The ONLY way to make sure you are running the latest version is to use the *Check For Latest Version* feature (in the HELP menu) or to download the latest installer from our web site. If you cannot obtain/install program updates using either of these means, contact technical support at: support@motionsoftware.com.

Un-Installing This Simulation

You can un-install this simulation by either: 1) Use the program removal feature in Windows (**Start** menu, select **Control Panel**, then choose **Programs and Features**, or 2) Use the *Uninstaller* placed in the Program folder (**Start** menu, select **All Programs** or **Apps**, then choose **Motion-Dynomation6 Engine Sim** or **Motion-DynoSim6 Engine Sim**, and finally click on the **UNInstall**).

Installing & Starting Version6 Simulations

Solving Installation And Operational Problems

Important Note: *You can obtain technical support and program updates by visiting (www.MotionSoftware.com). Open the **Start** menu, select **Programs** or (**Apps**), **Motion-Dynomation6 Engine Sim** or **Motion-DynoSim6 Engine Sim**, then click on the **Tech Support Website** icon. Contact our Tech Support staff by sending an email to support@motionsoftware.com.*

If you experience problems installing or using this simulation, please review the information presented in this Users Manual, including the information earlier in this chapter, the FAQs later in this manual, and check online for program updates (www.MotionSoftware.com/support.htm).

Send any mail correspondence to:

Motion Software, Inc.
222 South Raspberry Lane
Anaheim, CA 92808-2268

Other contact information:

Voice Line: 714-231-3801
Web: www.MotionSoftware.com

Tech Support (Preferred Contact Method) **Email: support@motionsoftware.com**
Tech Support Fax: 714-283-3130

Tech Support Email: support@motionsoftware.com This is the best way to reach Dynomation tech support quickly. Always include your email address and attach any .DXML engine files that may help diagnose problems. Include a thorough explanation of the steps that lead up to the fault.

Note1: Tech support will only be provided to registered users. Please complete the *Registration Form* that appears when you first start your software to qualify for technical support from the Motion Software staff (or select *Registration* from the HELP menu in the program).

Note2: If you need to update your address or any other personal information, simply select *Registration* from the **Help** menu, make any necessary address changes, then press **Register Now!** to transmit your updated info.

Wave-Action Filling & Emptying Simulations Version 6

OVERVIEW

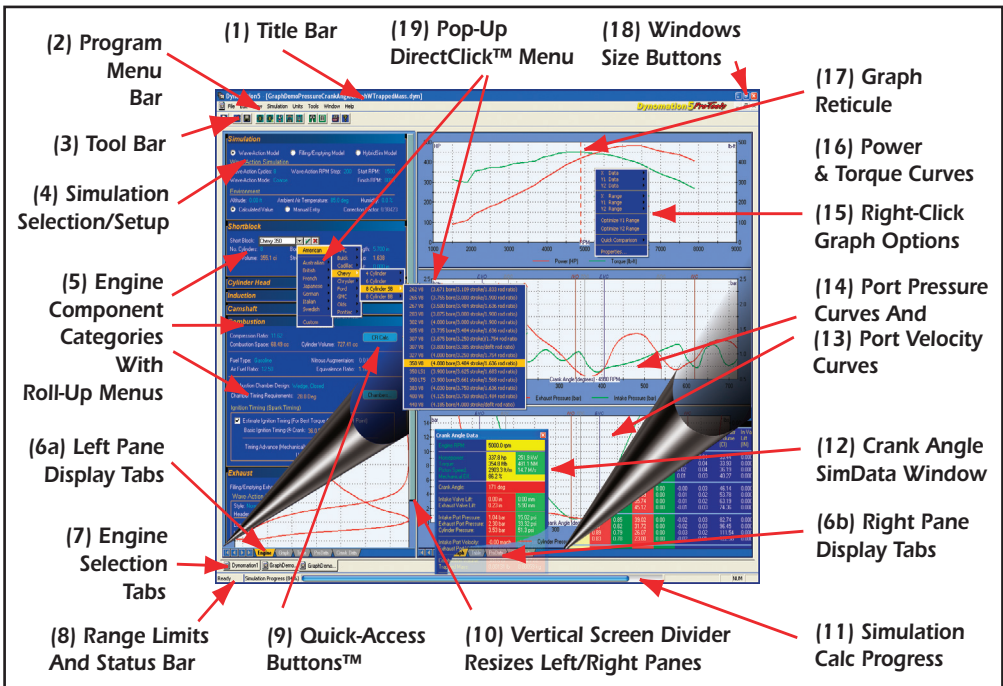

THE MAIN PROGRAM SCREEN

The left side of the **Main Program Screen** includes component categories that you can use to select simulation models and enter engine components, dimensions, and specifications. The right side of the screen displays simulation results consisting of graphs, charts and tables. The Main Program Screen is composed of the following elements:

- 1) The **Title Bar** displays the program name followed by the name of the currently-selected engine.
- 2) The **Program Menu Bar** contains pull-down menus that control overall program

Program Overview

Program Menu Bar

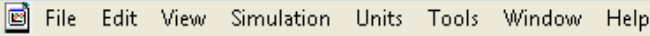

File Edit View Simulation Units Tools Window Help

Program Menu Bar contains nine pull-down menus that control overall program function.

function. Here is an overview of these control menus, from left to right:

File—**Opens** and **Saves** version6 (.DXML) files; **Imports** other Motion simulation files, including previous version Dynomation4 and 5 engine files, DynoSim4 and 5 and even various DOS-based engine files; **Exports** crank-angle and rpm-based engine test data in an Excel-importable format; **ProPrint™** generates a comprehensive report of engine components and simulation results, finally, the bottom of the **File** menu displays the most recently used simulation files, and contains a program-exit function.

Edit—Clears all component choices from the currently-selected engine (the current engine is highlighted on the *Engine Selection Tabs* at the bottom of the screen; see *Engine Selection Tabs*, later in this section).

View—Allows you to display the **Toolbar(3)**, **Status Bar(8)** and **Workbook** (see the *Workbook note*, below) layout features. The View menu also includes a choice to reset all graphs to program defaults.

Note: The **Workbook** features activate the *Engine Selection Tabs(7)* at the bottom of the screen, allowing rapid switching between simulated engines. If you have limited screen space (or you only simulate one engine at a time), you can turn off the Workbook features and access multiple simulated engines from the *Windows* menu.

Simulation—**Run** forces an update (recalculation) of the current simulation. **Auto Run** enables or disables (toggles) automatic simulation update every time a component is changed. You can also display a **Simulation Log** that contains diagnostic information about the simulation just completed. The **Graph...On** Baseline selection will re-scale pressure graphs to position the

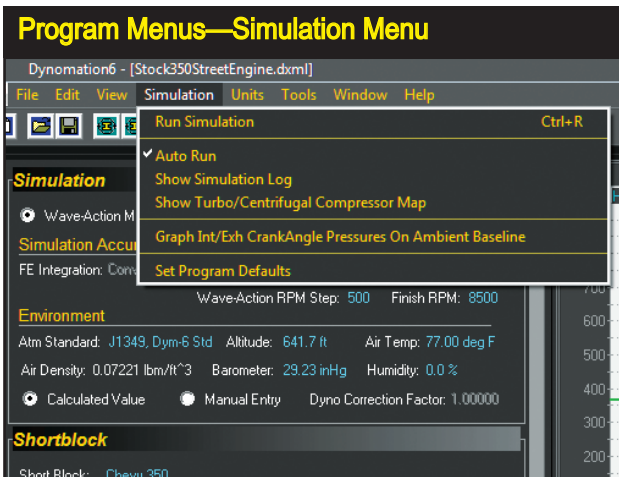

Each Program Menu provides access to overall program features. Here the **Simulation Menu** lets you to choose when the simulation is performed and whether the SimLog and Blower-Map dialogs are displayed. You can also open a **Program Default** dialog where startup characteristics for the software can be modified.

Program Overview

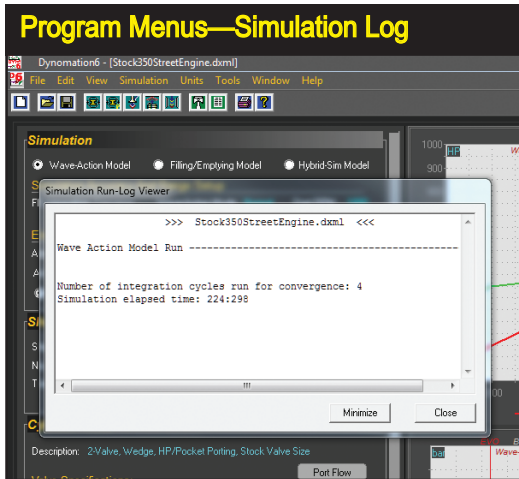

A Program Run Log can be displayed using the **Simulation** drop-down menu. This provides info about the just-completed simulation process, including execution times. Errors, like the lack of convergence or intake restriction warnings (if generated), can be helpful in diagnosing component-setup and other simulation issues.

curves on the baseline (helpful when modeling forced-induction engines). A **Blower Map Window** can be displayed that shows the compressor map and engine demand line for Turbo and Centrifugally supercharged engines; essential in diagnosing compressor selection, surge or choke issues. The Simulation menu also includes a **Program Setup** selection that lets you personalize simulation startup characteristics.

Units—Selects between US/Domestic and Foreign/Metric units. A hybrid units system also is available that displays components in Metric with Power/Torque and Airflow in US units.

Tools—Opens **Quick** and **Pro Iterater™** testing windows, the **Cam Manager™** dialog, or one of several built-in, cam/airflow/conversion calculators.

Window—A standard Windows menu for arranging and selecting engine display windows.

Help—Gives access to this **Users Guide**, **Registration**, **Program Updates** and related program features and information.

- 3) The **Tool Bar** contains a series of icons that speed up the selection of various program functions and features. The **Tool Bar** contains the following icons/functions: 1) Create New Engine, 2) Open Saved Engine, 3) Save Current Engine, 4) Open Quick Iterater, 5) Open **Pro Iterater™**, 6) Open Port Flow Dialog, 7) Open Compression-Ratio Calculator, 8) Open Airflow-Conversion Calculator, 9) Open Piston Animation, 10) Open Crank-Angle SimData™ Window, 11) Generate A ProPrintout™ Of The Current Engine, 12) Display Program "About Box."
- 4) The **Simulation Category** is the topmost **Engine Component Category(5)**, and is titled **Simulation**. Use this group to select a simulation model and make simulation-specific setup choices, such as the engine test rpm range, ambient atmospheric conditions, etc.

Program Overview

Component Category Status

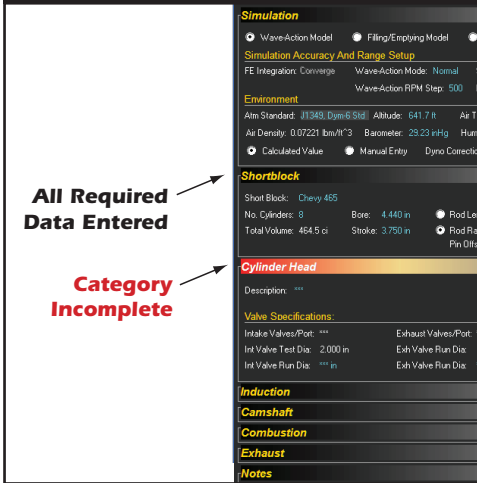

The status of the Component Categories are indicated by the color of the **Category Title Bars**. The Title Bars are either **red tone**, indicating that required data has not been entered (inhibiting a simulation run), or **dark tone** indicating that all required data in that category has been entered. The simulation determines whether a category is “complete” based on the simulation method selected. For example, the *Filling-And-Emptying* model requires fewer data values than the *Wave-Action* model. As a result, categories may indicate dark when *Filling-And-Emptying* is active, but may switch to red when the *Wave-Action* model is activated, indicating that additional data in those categories is required.

- 5) The remaining **Engine Component Categories** are made up of the following groups:

ShortBlock—Select the bore, stroke, number of cylinders, pin-offset, and rod length and/or rod ratio in this category.

Cylinder Head—Select the cylinder head type from generic choices in the menu or enter custom data using the Port-Flow dialog (click the Port-Flow button).

Induction—Select intake manifold designs, airflow rates, pressure drop and runner temperatures for the induction system. Also select intake runner and plenum dimensions for the Wave-Action simulation. At the bottom of the *Induction* category you can activate and configure a forced-induction system for any engine. Roots and Screw blowers, Centrifugal superchargers, and Turbochargers are supported.

Camshaft—Select the camshaft type, activate V-V-T (variable valve timing similar to Honda’s VTEC), set various cam timing/specifications, and displays the *True Timing* used by the simulation. Buttons open the *CamManager™*, *Rocker-Math™* dialog, and the *Lobe-Profile Import* dialog.

Combustion—Selects the compression ratio, the type of fuel, air/fuel ratio, nitrous flow rate, combustion chamber design, and ignition timing.

Exhaust—Selects the exhaust-system configuration, runner and tubing dimensions and interconnection specifications.

Notes—Enter any comments about the current simulation. Notes are saved with the engine .DXML file.

Note: Each component category indicates its status by the color of the **Category**

Program Overview

Component fields that do not yet contain valid entries are marked with a series of asterisks. This indicates that the field is empty and can accept data input. Most numeric fields accept direct keyboard entry and/or selections from the provided drop-down menus. Some selection fields (like the *Cylinder Heads Type* menu) only accept selections from the associated drop-down menu. When a valid selection has been made, it will replace the asterisks.

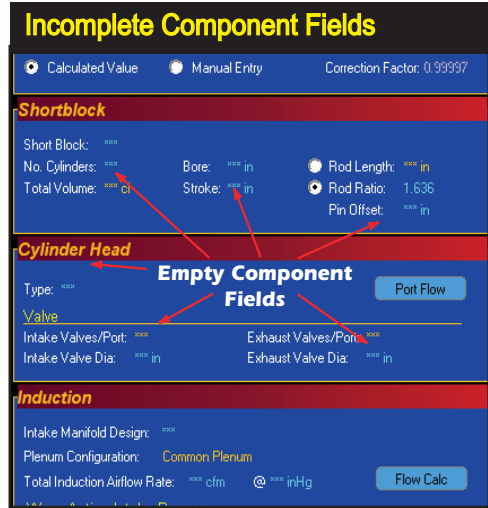

Title Bar. The Title Bars have either a **red tone**, indicating that the category is not complete (inhibiting a simulation run), or a **dark-tone** indicating that all components in that category have been selected. When all component categories indicate complete, a simulation can be performed (calculation will begin automatically if the *Auto Run* feature is selected in the *Simulation Menu*).

- 6a & 6b) The Main Program Screen window is divided into two panes. The left and right panes each provide a set of **Screen Display Tabs** at the bottom. Use these tabs to switch the left and right pane displays to tables, graphs, or other simulation displays.
- 7) This software can simulate several engines at once (supports multiple open documents). Switch between “active” engines (documents) by selecting any open engine from the **Engine Selection Tabs**, located just above the **Status Bar** at the bottom of the main program screen (engine selection can also be made from the *Windows Menu*). The current engine is highlighted on the foreground Tab. The name of the currently-selected engine is also displayed in the program **Title**

The Main Program Screen window is divided into two panes. The left and right portions of each contain a set of **Screen Display Tabs** located at the bottom of the panes. Use these tabs to switch the displays to **Engine** component lists, **Tables**, **Graphs**, or other data displays.

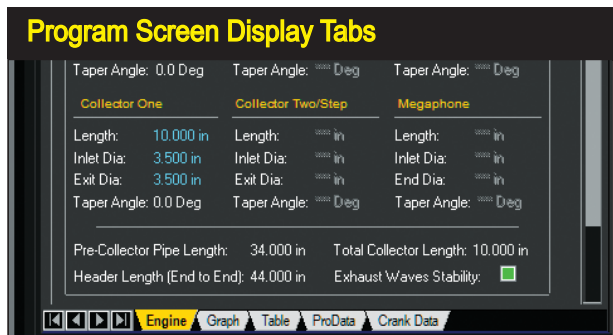

Program Overview

The simulation can work with several engines at once. Switch between engines by selecting any available engine from the *Engine Selection Tabs*, located just above the Status Bar at the bottom-left of the main program screen. The currently-selected engine is highlighted in the foreground (colored) Tab. Note: the Status Bar displays “Ready” in this photo.



Bar.

- 8) All Component Category menus allow either direct numeric entry or menu-selection choices, and some accept both. During data entry, the range of acceptable values and other helpful information will be displayed in a **Range Limit Line** within the **Status Bar** at the bottom-left corner of the main program window.
- 9) Several component categories contain **QuickAccess Buttons™** that give “one-click” access to important data-entry functions and calculators. The **CYLINDER HEAD** category contains a **PortFlow** button that opens the Port-Airflow dialog box, allowing direct entry of flowbench data; the **COMPRESSION** category contains a **CR Calc** button that opens the Compression-Ratio Calculator, a tool that can save time and improve accuracy in determining engine compression ratio; the **INDUCTION** category contains a **FlowCalc** button that allows quick airflow calculations from throttle diameter, etc.; and the **CAMSHAFT** category contains the **CamManager™**, **Rocker Math™**, and **Import Profile** buttons that give ready access to important tools that help you with cam simulation and valve-timing modifications.
- 10) The widths of all program panes are adjustable. Simply drag the **Vertical** or **Horizontal Screen Divider** to re-size the Component-Selection and Graphics-Display panes. **Horizontal Dividers** are located between the right-hand graphs. By adjusting the position of these dividers, you can increase the display size of the power-curve and pressure/flow displays for optimum resolution.
- 11) The **Simulation Progress Indicator** (appears in the **Status Bar** when a simulation calculation is underway) shows the progress of calculations for the selected simulation model. Each “step” of the progress bar indicates the completion of a simulation at one rpm point.
- 12) The **Crank-Angle SimData™ Window** (see photo, next page) displays the exact values of port pressures, flow rates, horsepower, and more at various rpm and crank-angle points. Click on the rpm graph to set the rpm reticule line, then click

Program Overview

The **Crank-Angle SimData™ Window** displays the exact values of port pressures, flow rates and other simulation data at various rpm and crank-angle values. Click on the rpm graph to set the rpm reticule line, then click on any crank-angle graph to display a crank-angle reticule. As you drag the reticule left and right, exact data values at the reticule intersections will be displayed in the **SimData™ Window** (open the **SimData Window** from the **Tools** drop-down menu).

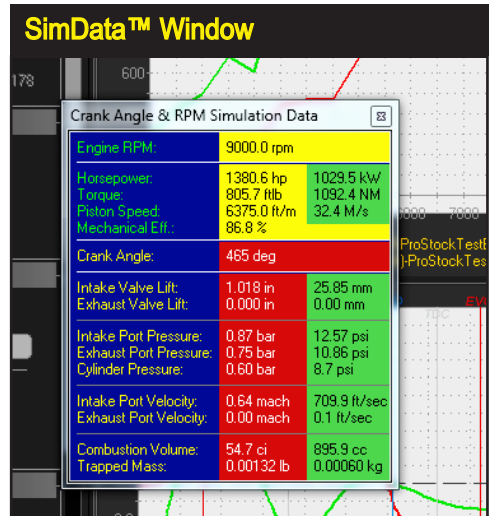

on any crank-angle graph to display a crankangle reticule (see 17, below). As you drag the reticule left and right across the graph, exact data values under the reticule intersection will be displayed in the **SimData™ Window** (open the **SimData Window** from the **Tools** drop-down menu).

- 13) The **Port Velocity** lower graph displays port flow rates at various rpm and crank-angle values (velocity is default display; can be customized with the right-click menu). The displayed velocity values are calculated at the location of minimum cross-sectional area in the port. Click the top horsepower/torque graph to display a reticule line and establish the rpm for viewing flow and pressure data. Drag the reticule left and right on the **RPM** graph to establish the port flow data (in the lower graph) at each of the selected engine speeds. Click on the **Port Velocity** (lower) graph to display a crank-angle reticule line; the exact data at the reticule intersection are displayed in the **SimData™ Window** (see 12, above).
- 14) The **Port Pressures** are displayed in the middle graph (pressure is the default display; can be customized with the right-click menu). The displayed pressures are calculated at the location of minimum cross-sectional area in the port. Click on the top RPM-based horsepower/torque graph to display a reticule line and establish the rpm for viewing pressure and velocity data. Drag the reticule left and right on the **RPM** graph to establish the port pressure data (in the center graph) at each of the selected engine speeds. Click on the **Port Pressures** graph to display a crank-angle reticule line; the exact values at the reticule intersection are displayed in the **SimData™ Window** (see 12, above).
- 15) The various graphs display horsepower, torque, port pressures, flow rates, valve lift, and more for the currently-selected engine. These graphic displays

Program Overview

The Graph Options Box allow you to customize any graph. Right-Click to Reassign the X, Y1 and Y2 curves to different data sets, to set *Optimize* functions, to setup *Quick Comparisons*, to assign custom axis *Properties* and setup multiple engine-to-engine comparisons.

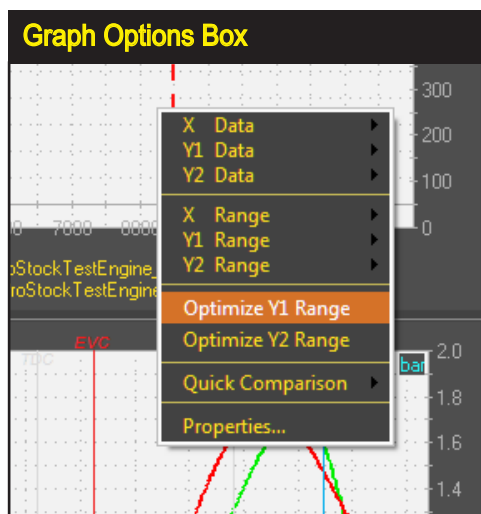

can be customized to display additional data in many formats using the **Graph Options Box**. To display the **Options Box**, *right-click* on any graph; reassign the **X**, **Y1** (left axis) and **Y2** (right axis) curves to any of the data sets provided in the submenu. **Optimize** functions quickly setup curves for best visual resolution. **QuickCompare™** will setup sim "baselines" to help evaluate changes or establish comparisons with other engine files (discussed in detail later in this manual). Finally, use the **Properties** choice at the bottom of the menu to open the **Graph Properties** box where you can assign custom axis values and setup multiple engine-to-engine comparisons.

- 16) The **Horsepower And Torque** top graph displays engine output throughout the simulation rpm range (HP and Torque are the default displays; the graphs can be customized using the right-click menu). Click on the graph to display a reticule line. The exact data at the reticule intersection can be viewed in the **SimData™ Window** (see 12, and photo on previous page). In addition, horsepower and torque results (and much more) are displayed in the data tables; click the **Table**, **ProData**, or **Crank Data Screen Display Tabs** near the bottom left and right of the Main Program Screen (see 6a & 6b, earlier in this section).
- 17) Each of the four graphs (the fourth is located "under" the Component Categories; to view this graph, click on a **Graph Tab** at the bottom of the left main-program window) incorporate a **Reticule Line** that appears when you left-click on the graph. You can "drag" the **Reticule Line** left and right across the graph between the lowest and the highest test rpm (for the horsepower and torque graphs), or between 0- and 720-degrees of crankshaft rotation (for the middle and lower port pressure/velocity graphs). The exact values of the underlying data at the reticule intersections is displayed are the **SimData™ Window** (see 12, earlier

Program Overview

The DirectClick™ Component Menus allow you to select components and specifications for each Component Category item (Combustion-Chamber specs are shown here). Click on any component specification to open its menu. The menu will close when a selection is complete (or accept the current selection by clicking on the green ✓). If you wish to close the menu before making a new selection, click the red X next to the drop-down box, click anywhere outside the menu, or press the Escape key until the menu closes.

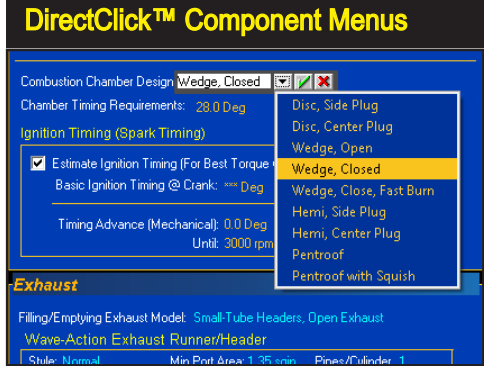

in this section).

- 18) The Main Program Screen incorporates **Windows Size Buttons**. These buttons provide standard maximizing, minimizing, and closing functions common to all Windows applications. Refer to Windows documentation for more information on the use of these buttons.
- 19) The **Pop-Up DirectClick™ Component Menus** allow the selection of components and specifications within each of the Component Categories. Click on any component specification to open its menu. The menu will close when a selection is complete. If you wish to close the menu before making a new selection, click the red X next to the drop-down box, click anywhere outside the menu box, or press the **Escape** key until the menu closes.

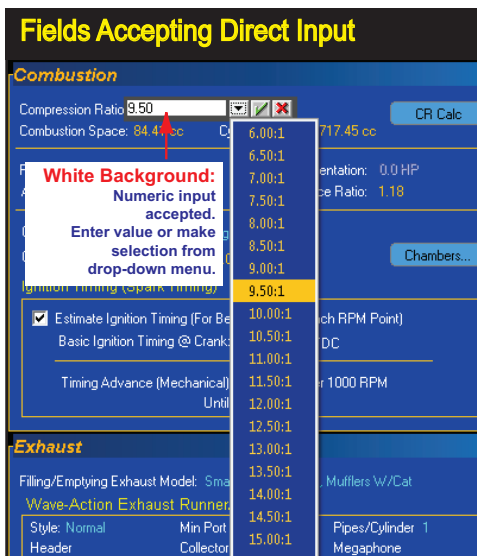

Component fields that support direct numeric entry have white bounding boxes (left). When the only selection possible is a choice from the drop-down menu, the bounding box will have a gray interior (below).

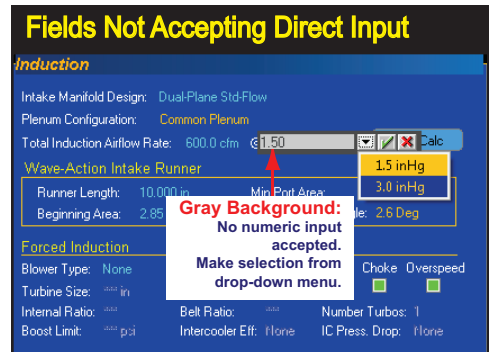

Program Overview

Direct-Input vs. Menu-Input Component Categories

Component menus fall into three categories: 1) Those that accept direct user input (custom values), 2) those that only accept a selection from their attached drop-down menu, and 3) those that accept input from either direct input or menu selections. For example, the **Number Of Cylinders** menu in the *ShortBlock* category will accept direct input (any integer value from 1 to 16), and you can also select common cylinder combinations from the drop-down menu. When a menu supports direct-data entry, the component-entry bounding box will have a white interior (see photos). On the other hand, the **Pressure Drop** menu associated with the *Total Induction Flow Rate*, will only accept one of the two selections from its attached menu (1.5- or 3.0-inHg). The data entry box for these input fields have a light-gray interior (rather than white).

Note1: Almost all custom-input categories include an attached menu from which common data inputs are also provided.

Note2: Data entry into any component field is limited to values over which this software can accurately predict power. The range limits are displayed in the **Range Limit Line** within the **Status Bar** at the bottom-left of the Main Program Screen. If you enter an invalid number, the simulation will sound the Windows error tone and wait for new input.

Keyboard Selections And Shortcuts

The following keyboard “speed tips” will help you make the process of data entry and “what-if” testing more efficient. None of these operations are essential, and if you prefer to only use a mouse, you can skip this section.

Cursor Arrow Keys Move Reticule Lines—You can move the reticule lines on any of the graphs in small increments by using the *Cursor Arrow* keys. First, click on a graph to “select” it, then use the **Right-Arrow** key to move the reticule line to the right; use the **Left-Arrow** key to move it to the left. If you hold the **SHIFT** key, the increment of movement on the crank-angle graphs increases to 10-degrees.

Opening Menu-Bar Menus—Press and hold the **Alt** key, then press the **F** key to highlight and open the File menu (in the Menu-Bar at the top of the program screen). Use the cursor-arrow keys to move through menu selections; press the **Right-Arrow** key to open submenus and the **Left-Arrow** key to close submenus. With any menu open, you can also use the right-and-left arrow keys to activate other menu-bar menus—e.g., *Edit*, *View*, *Simulation*, etc. When you have highlighted the menu selection you wish, press Enter to accept the selection. Press **ESC** (the escape key) repeatedly to close the menus without making a selection.

Program Overview

Note: You can also use the **Alt** key combination with the **E, V, S, U, T, W,** and **H** keys to directly open the other program drop-down menus.

Moving Through Component Fields—After you have selected any field within a component category, you can press the **TAB** key to move the highlight from field to field within that category. Tab key-presses will not open fields for data entry, but rather will move the focus highlight from field to field. Tabbing always keeps field selection within the current category.

Note: The **Shift Tab** key combination will move the highlight box backwards to the previous component field.

Entering Data In Component Fields—When you've highlighted a component field, press the **Enter** key once to convert the highlight to a data-entry bounding box. Then key in your data (or open the drop-down menu and make a selection), finally press the **Enter** key again to close the bounding box and accept the data. To move to the next field, you can press the Tab key, or you can again press **Enter**. Using Enter instead of the Tab key not only moves the highlight to the next field, but also opens the data-entry bounding box in one step. So by pressing keys in the sequence "Enter, Enter, (data entry), Enter Enter," you can quickly enter (or jump past) data in all component fields within a specific component category.

THE MEANING OF SCREEN COLORS

The colors used on the component-selection screen provide information about various engine components and specifications. Here is a quick reference to screen color functionality; these descriptions apply to the default color scheme:

The colors used on the component-selection screen provide information about what fields are currently being used and whether you can modify these components. This is the *Dynomation6* (default) color scheme; White/Cyan indicates components that can be entered and modified, while white/light-gray are fields that indicate "display-only" (like *Runner Connections* and *Average Taper Angle*, shown in the Induction category.).

Screen Colors

Intake Design: Simple Plenum Model

Runner Connections: Common Plenum Ave. Runner Temp: 180.00 deg

Total Induction Airflow Rate: 1200.00 Cfm @ 1.50 inHg Flow Calc

Wave-Action Intake Runner/Plenum:

Primary Runner Specifications		Manifold Plenum Volume	
Length (Min Area to Entry):	9.500 in	Plenum Volume:	100.0 ci
Min Port Area (per Valve):	1.00 sqin	Calc From Length:	6.362 in
Port Entry Area (Max Area):	2.00 sqin	Calc From Width:	3.790 in
Average Taper Angle:	2.8 Deg	Calc From Depth:	3.790 in

Bellmouth Not Available On FE Sim Induction Waves Stability:

Forced Induction Specifications:

Compressor: Turbo-Garrett-GTX3071R-71-58

Turbine Size: 2.800 in Internal Ratio: 1.00 Surge Choke Overspeed

Turbine A/R: 0.70 Belt Ratio: 1.00

Number Turbos: 1

Boost Limit: 20.0 psi IC Press. Drop: 0.5 psi Intercooler Eff: 100.0 %

Program Overview

White: Most engine component field names (not the component values) are displayed in white. This indicates that their associated data fields are required for a simulation to be performed.

Light Blue (Cyan): Engine component values displayed in light blue can be entered into the program and/or modified. For example, the value of **Total Induction Airflow** in the Induction Category is Cyan and can be changed to any value within the limits of the simulation.

Light Gray: These “display only” values have been automatically calculated by program and cannot be directly modified. For example, the **Average Taper Angle** value in the Induction Category is a display-only value that is determined by the minimum and maximum port areas (values that you *can* enter in the program).

Note: The basic color functionality described here applies to the Dynomation6 default color scheme. While other color schemes may use some of these colors, not every color scheme uses the same default colors for data inputs. However, the differences in display colors within each color scheme will always reflect the same functionality described here.



FIVE-MINUTE TUTORIAL

Building And Testing An Engine Using *DynoSim6* And *Dynomation6* Simulations

This tutorial is primarily intended for first-time version 6 users. However, anyone wishing to get a quick overview of basic data entry, simulation setup and results analysis can benefit from following along with this step-by-step example.

The most common method of starting an engine-simulation project in this simulation is to “assemble” a test engine from component parts. In this tutorial, we'll quickly build a basic engine using the *Filling-and-Emptying* simulation model. Then, after we have obtained initial results, we'll modify a few components to determine how they affect engine output. Finally, we'll switch to the *Wave-Action* (*Dynomation6* only) simulation and continue to fine-tuning engine components.

Follow along with these steps for a quick overview of how to perform a simulations and analyze the results. While this may take you more than five-minutes to complete, once you are familiar with this simulation, you'll be able to do similar engine buildups and basic testing in *less than* five minutes.

One more thing before we begin: Make sure that current simulation *Units* have been set to **US** for this tutorial in the *Units Menu* at the top of the program screen.

Note: Engine power values and other simulation results shown in this tutorial may vary as the software is updated and/or new features are incorporated over time. The results shown here reflect the current version of the simulation at the time this chapter was last updated (the software version at publication is provided at the bottom of page, next to the page number).

Getting Started: Building An Engine From Scratch

- 1) If necessary, start the simulation. Select **New** from the **File** menu. Component categories on the left side of the program screen begin empty, indicated by a string of asterisks (****) next to each incomplete field.

Five-Minute, Engine-Buildup Tutorial

The DirectClick™ Component Menus are how you enter component values and specifications in the simulation.

Click on any component specification to open its menu. Click on the ▼ symbol inside the bounding box to open a drop-down menu of possible choices. The menu will close when a selection is complete (or manually accept the current selection by clicking on the green ✓). If you wish to close the menu before making a new selection, click the red X next to the drop-down box, or press the Escape key until the menu closes.

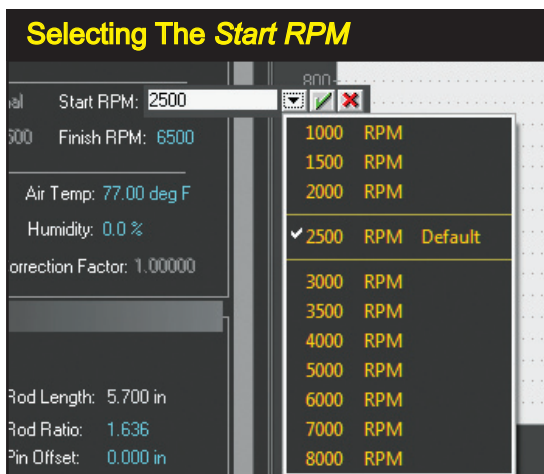

- 2) Data fields in the Component Categories accept your inputs within a “bounding box” that appears after you click on a data value. Click on the ▼ symbol inside the bounding box to open a drop-down menu.
- 3) Begin the engine build by moving your mouse into the **Simulation** category and (left) clicking the *Filling-And-Emptying Model* radio button, activating the *FE* simulation method (not necessary for DynoSim6 users). Then select the *RPM Range* values for the simulation as shown here:

The Simulation Category Choices:

- **Simulation Selection Radio Button:** Click on the *Filling-And-Emptying Model*.
 - **Start RPM:** Select *1000-rpm* from the drop-down menu.
 - **Finish RPM:** Select *6500-rpm* from the drop-down menu.
- 4) Leave the remaining fields in the Simulation Category with their default selections. The simulation will use the *J1394 Atmospheric Standard* widely used as a baseline in dyno testing. And the *Single-Pass Converge* selection for *FE Integration* will allow the simulation to run as fast as possible. (The number of integration cycles required to reach convergence is displayed in the Simulation Log, available from the *Simulation Menu*.)
 - 5) Now move to the **Shortblock** category (see photo, next page). Click on the asterisks in the **Short Block** field. Move through the menu choices and select **American**. When the submenu opens, select **Chevy, 8 Cylinder SB**, and finally click the left mouse button on **350 V8**.

Shortblock Category Choice:

- **Short Block:** Choose the *Chevy 350 V8* shortblock.

Five-Minute, Engine-Buildup Tutorial

6) The engine name, bore, stroke, number of cylinders, rod length, and pin offset are loaded into the *Shortblock* category. Each component category has colored **Title Bars** located at the top. They are either a **red-tone**, indicating that the category is not complete (inhibiting a simulation run), or a **dark-tone** indicating that all components in that category have been selected. When you make a selection from the *Short Block* menu, all the fields in that category is filled-in and the **red Title Bar** switches to **dark-tone**.

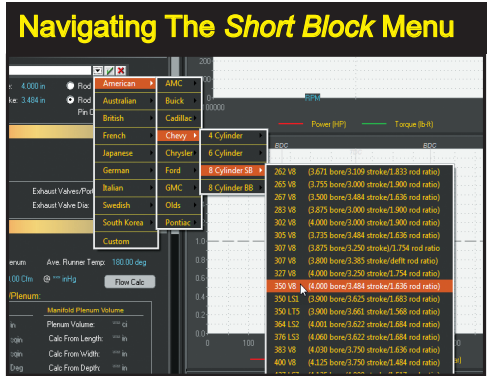

Pause over each selection to open a series of submenus. When you reach **350 V8**, click on it to load the selection into the simulation.

7) Now, move to the *Cylinder Head* component category and click on the asterisks (****) next to the **Description** field. Select **Domestic Cylinder Heads**, then from the submenu, right click on **2-Valve Wedge, HP-Stock Ports And Valves**. Notice that after you have made your selection, the category **Title Bar** remains red. This is because not all of the components fields in this category have been completed. Intake and exhaust valve diameters still need to be entered. To simplify this selection (and illustrate another program feature), let the simulation make a calculated “guess” of the valve diameters for you. Open either the **Intake Valve Diameter** or **Exhaust Valve Diameter** menu and select **Auto Calculate Valve Sizes**. This selection will calculate appropriate valve sizes based on bore size, cylinder-head flow, etc. This completes the *Cylinder Head* category; the **Title Bar** is now a **dark-tone**.

Cylinder Head Category Choices:

- **Description:** *Domestic Cylinder Heads / 2-Valve Wedge, HP-Stock Ports And Valves*.
- **Intake Valve Dia:** *Auto Calculate Valve Sizes*.

You'll notice that the simulation has assigned 1.94-inch intake and 1.50-inch

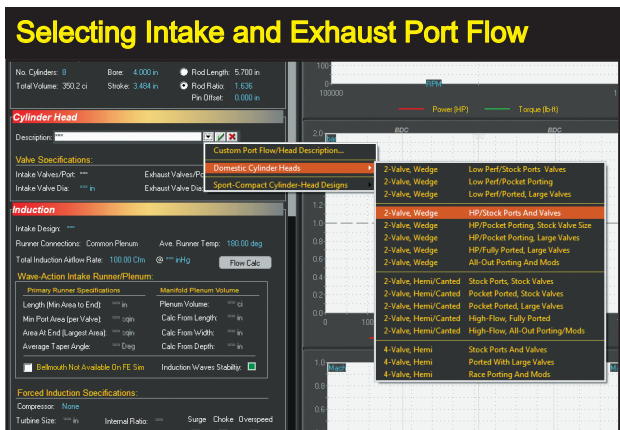

Five-Minute, Engine-Buildup Tutorial

exhaust valves to the cylinder heads. These sizes were calculated based on the cylinder head flow, engine bore diameter, and other engine specifications.

- 8) Continue moving down through the component categories and make the following selections:

Induction Category Choices:

- **Intake Manifold Design:** *Baseline Common Plenum.*
- **Average Runner Temperature:** *180-degrees F.*
- **Total Induction Airflow:** *650 CFM (for a 4/8barrel carb/ injection).*
- **Pressure Drop** (indicated by the “@” symbol): *1.5-InHg.*

Camshaft Category Choices:

- **Cam Type:** *Generic Cams For 2-Valve Engines / Stock Street/ Economy.*
- **Rocker Ratio:** Set both Intake and Exhaust Rocker Ratios to *1.5:1.*
- **Valve Lash:** Set both Intake and Exhaust Valve Lash to *0.000.*

Combustion Category Choice:

- **Compression-Ratio:** Select *9.5:1.*

Exhaust Category Choice:

- **Filling/Emptying Exhaust Model Menu:** *HP Manifolds, Muffler Without Catalytic Converter.*

Dynomation6 User Note: Since you are performing a *Filling-And-Emptying (FE)* simulation, the component fields that are directly related to the *Wave-Action (WA)* simulation are dimmed and do not require data entry.

The Main Graph Displays

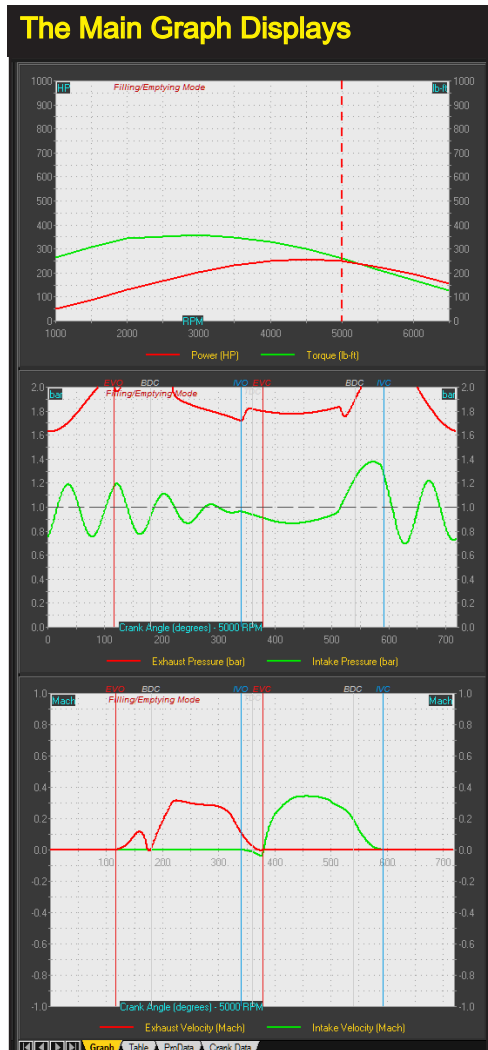

Rpm-based results are shown on the top graph (horsepower, torque, etc.); crank-angle based data on the center and lower graphs (pressures, velocities). Use the *Selection Tabs* to display data tables.

Five-Minute, Engine-Buildup Tutorial

Table Display Of Simulation Results

Calculated Power and Engine Pressures

Engine RPM	Power (HP)	Torque (LB FT)	Power (WHEEL) (HP)	Torque (WHEEL) (LB FT)	Indicated Power (HP)	Brake Power (HP)	Frictional Power (HP)	Pumping Power (HP)	Piston Force (LBS)	Piston Speed (FT./MIN)	Ignition Timing (deg)	Vol. Eff. (%)	Mech. Eff. (%)	Fuel Conv.Eff (%)
1000	60	315	48	252	63.6	60.0	3.6	0.1	1808	580.7	24.9	85.0	94.2	25.1
1500	99	346	79	277	106.3	98.8	7.2	0.2	2038	871.0	26.7	87.9	93.0	27.1
2000	138	362	110	290	180.4	137.9	12.0	0.4	2152	1161.3	28.4	89.6	91.7	27.6
2500	174	365	139	292	192.9	173.9	18.1	0.8	2195	1451.7	30.1	90.2	90.2	27.5
3000	206	361	165	289	233.1	206.4	25.4	1.4	2222	1742.0	32.8	91.6	88.5	27.0
3500	229	344	183	275	265.0	229.1	33.9	2.0	2157	2032.3	34.4	89.5	86.5	26.1
4000	241	316	193	253	287.3	240.9	43.6	2.8	2044	2322.7	35.6	86.9	83.9	24.7
4500	236	275	188	220	293.9	235.6	54.5	3.7	1862	2613.0	36.0	82.1	80.2	22.8
5000	208	219	167	175	279.8	208.5	66.7	4.6	1594	2903.3	37.1	75.5	74.5	19.8
5500	159	152	127	122	244.7	159.3	80.1	5.9	1286	3193.7	37.7	66.9	65.1	15.5
6000	93	61	74	65	193.5	93.0	94.9	5.7	916	3484.0	38.2	57.5	49.1	9.6
6500	13	11	11	9	129.6	13.4	110.7	5.5	567	3774.3	38.3	47.1	10.3	0.0
Averages Based On RPM Range Selected In Simulation Category:														
	155	262	124	210	203	155	46	3	1735	2178	33.4	79.2	75.5	21.1

Click the **Table Tab** at the bottom of the graph pane (see photo on previous page) to switch to a table view of exact power values and other simulation results.

Simulation Results: At this point, all the *Category Title Bars* should be **dark-tone**, and the simulation will display power and torque curves (in the RPM graph located at the top-right of the main program screen). The engine produces about 240-hp at 4500-rpm; typical of “old-school” 1960’s, V8 street engines with mufflers and restrictive catalytic converters.

Problems?: If the simulation did not run, first check that all the *Category Title Bars*, in fact, have switched to **dark-tone**. Next, make sure that **Auto Run** is checked in the *Simulation Menu* (located at the top of the screen). Finally, check each data-entry field to make sure you entered the correct values.

Helpful Engine Files: Engine files that duplicate the status of your engine at several points during this tutorial are included with the simulation in the default engine files directory *C:\Dynamotion6\Engine Files\Engine-Files (.DXML Dynamotion-6) or C:\DynoSim6\Engine Files\EngineFiles (.DXML DynoSim-6)*. For example, the file **FiveMinuteTutorial_Step8.dxml** should be identical to your engine at this point in the tutorial (providing the software versions are identical). You can load the tutorial engine files to compare component selections and check your progress.

- Now let's make a few component changes, but before we do, it's helpful to establish baseline curves on the graph so that we can easily compare changes in power and torque. Called **QuickCompare™**, activate this function by right-clicking anywhere in the Power/Torque graph, then from the pop-up *Options Menu*, select **QuickCompare™**. Finally, select **Make From Current Test**.

RPM-Based Graph Option (right-click menu):

- QuickCompare™: Make From Current Test.**

Five-Minute, Engine-Buildup Tutorial

This creates a new, identical engine in the simulation called **CompareRun1** (a new **Engine Tab** will be shown at the bottom-left of the screen). At the same time, a “side-by-side” comparison is established on the current graph with data from the newly created baseline engine (the comparison curves lie directly underneath the existing power and torque curves on the graph...the curves exactly match because the new baseline engine, *CompareRun1*, is identical).

- 10) Now, change the cam to the next choice from the **Cam Type** menu: A High-Performance Street grind:

Camshaft Category Choice:

- **Cam Type:** *Generic Cams For 2-Valve Engines / High-Performance Street Profile*

The new cam creates more power; the engine now produces about 260-hp at 4500-rpm. But there has been a significant sacrifice in torque below 4000-rpm.

Click on the Power/Torque graph to activate a *reticule line* that marks the rpm point at which data is obtained for the center and lower graph displays of intake and exhaust pressure waves and flow velocities. Drag the reticule line back and forth across the rpm graph. The changing pressure and velocity curves were recorded at each rpm point during the simulation.

Notice that exhaust pressure (the red curve on the center, crank-angle graph) is averaging about 1.7-bar (that's about 10-psi backpressure in the exhaust system at 5000-rpm). To get a better feel for the capabilities of this engine, let's see how it responds to a more free-flowing exhaust system. Install a set of small-tube headers with open collectors (a typical dyno setup):

Exhaust Category Choice:

- **Filling/Emptying Exhaust Model:** *Small-Tube Headers, Open Collector*
- **Filling/Emptying Exhaust Tune RPM:** *5000.*

- 11) The comparison curves now show the improvements in power and torque across all engine speeds! The engine now produces almost 330-hp at 5000-rpm. Low-speed torque was either maintained or boosted throughout the rpm range. The results show that high exhaust

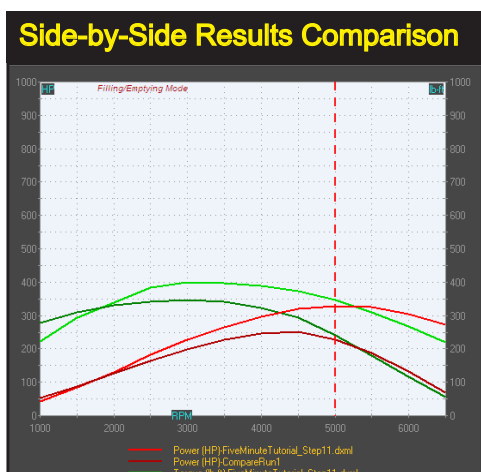

Here is the Side-By-Side comparison of the 350 engine after the HP Street Profile cam and small-tube headers were installed. The significant boost in higher rpm power was obtained with little loss in low-speed torque.

Five-Minute, Engine-Buildup Tutorial

backpressure and a lack of cylinder scavenging (caused primarily from muffler restriction) significantly limited the potential of this engine.

We've also learned that the cylinder heads are able to supply substantial additional flow; if this were not true, the power increase from open headers would have been much less.

This is starting to get interesting! Before we proceed, let's perform another *QuickCompare™* to set current results as a new baseline *RPM-Based Graph Option* (right-click menu):

- **QuickCompare™:** *Make From Current Test*

Note: The engine configuration at this point in the tutorial was saved as *FiveMinuteTutorial_Step11.dxml*.

- 12) To determine if this engine has more airflow potential with the current cam timing and cylinder heads, let's improve the induction system by testing a tuned intake manifold. Since this is still a street engine, we'll select a manifold suitable for this application.

Induction Category Choices:

- **Intake Manifold Design:** *Dual-Plane Std-Flow* (from the *Plenum, Domestic* sub menus)

This Dual-Plane manifold is designed to boost torque within the rpm range of a typical street engine. The power now stands at about 350hp at 5000-rpm, and we also see an accompanying boost in torque across the rpm range.

- 13) Let's try another improvement in the induction system. This time we'll install high-performance OEM cylinder heads that offer improved flow (primarily from pocket porting techniques, performance valves, seats, etc.).

Cylinder Head Category Choices:

- **Description:** *2-Valve, Wedge, HP/Pocket Porting, Stock Valve Size.*

The additional port flow generated virtually no negative affects on torque (thanks, in part, to the Dual-Plane manifold), however, the horsepower jumped up to nearly 410hp at 5500-rpm. But that's with open headers. Let's see how much power we can expect if mufflers are installed after the headers.

Exhaust Category Choice:

- **Filling/Emptying Exhaust Model:** *Small-Tube Headers, Mufflers, W/O Cat*

Based on the exhaust pressure estimates within the simulation, the power dropped about 40 hp. The engine now produces about 370hp; not bad for a

Five-Minute, Engine-Buildup Tutorial

Side-by-Side Results For Step 13

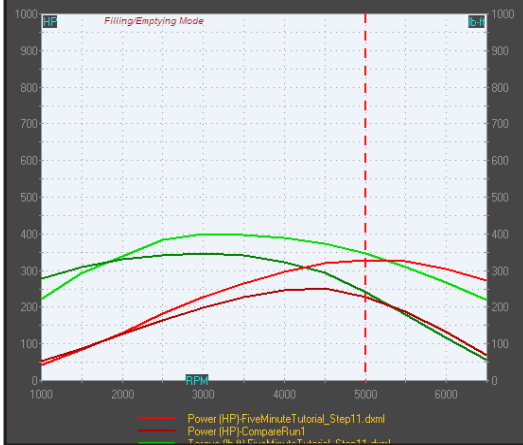

After the installation of a Dual-Plane manifold and cylinder heads with improved port flow, the engine performance is obviously much better, despite the restriction from mufflers added to the collectors of the small-tube headers.

relatively inexpensive street hot-rod buildup. The engine in this configuration was saved as *FiveMinuteTutorial_Step13.dxml*.

Note: Mufflers vary widely and some engine builders are confident that well-designed high-flow exhaust systems would reduce power by less than 20hp over open headers on this engine.

- 14) **USING Dynomation6 Wave-Action Simulation:** The remaining portion of this tutorial covers intake and exhaust port and tubing modifications; features available only in Dynomation6, Motion Software's professional Wave-Action simulation.

Before we proceed, switch the FE model back to Small Open Headers. This will provide a more appropriate back-to-back comparison with the Wave-Action simulation we perform in the next steps.

Exhaust Category Choice:

- **Filling/Emptying Exhaust Model:** *Small-Tube Headers, Open Collector*

Now we'll look into some of the capabilities of the *Wave-Action* simulation to delve deeper into the power potential of this engine. Switch to the **Wave-Action Model** in the *Simulation Category*.

Simulation Category Choice:

- **Sim Model Radio Button:** *Wave-Action Model*

- 15) You may have noticed that the *Title Bars* of the *Induction* and *Exhaust Com-*

Five-Minute, Engine-Buildup Tutorial

Intake Runner Dimensions

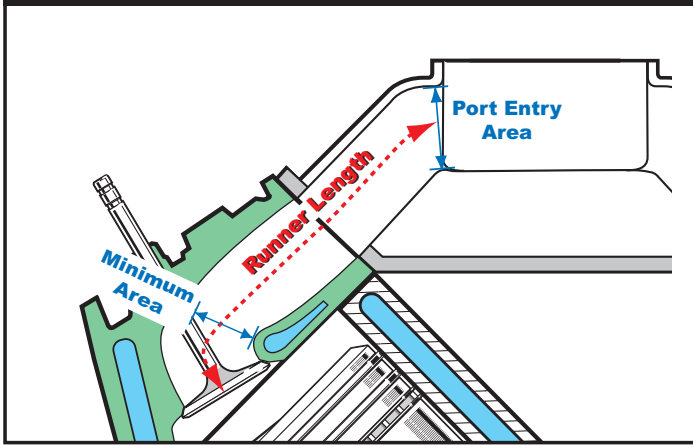

Intake Runner Length is defined as the distance from the intake-valve seat to the point in the port where the area substantially increases. *Port Entry Area* is measured at the port entrance junction with the plenum or just inside the runner bellmouth. And *Minimum Port Area* usually occurs just above the valve seat, near the valve guide.

ponent categories have now switched from a **dark-tone** to **red**, indicating that the Wave-Action model lacks sufficient data in these categories to complete the simulation. Fill in the missing component data with the following values:

Induction Category Choices:

- **Runner Length:** 10.5 inches
- **Minimum Port Area:** 1.25 sq-inches
- **Port Entry Area:** 3.0 sq-inches
- **Plenum Volume:** 100 cubic-inches (when you enter plenum volume, the program will display default plenum dimensions; these are for reference, the simulation only uses *volume* in its calculations).

Exhaust Category Choices:

- **WA Exhaust Type:** Basic Header--(Pipes Merge At Collector)
- **Min Port Area** (for each exhaust port): 1.0-sq-inches
- **Primary Pipes Per Cylinder:** 1 pipe-per-cylinder
- **Primary Length:** 36-inches
- **Primary Inlet Diameter:** 1.5-inches
- **Primary Exit Diameter:** 1.5-inches
- **Collector Length:** 18-inches
- **Collector Inlet Diameter:** 3-inches
- **Collector Exit Diameter:** 3-inches

- 16) The *Wave-Action* power and torque curves are similar to the FE at peak values, but the torque curve has a slightly different shape. This is due to the more extensive pressure-wave modeling used in the wave-action sim.

Note: The results would not have matched while the FE if the exhaust system

Five-Minute, Engine-Buildup Tutorial

was no switched back to the open-header model, since the WA does not model the backpressure created by mufflers or catalytic converters.

- 17) Now we'll dig a little deeper into pressure waves in the intake runners by testing the effects of *Intake Port Areas*. The **Minimum Port Area** is the smallest cross-section in the intake port, and is typically located just after the valve seat, near the valve guide. Currently we are using a value of 1.25-in² for this restriction. Try changing this value to 2.0-in².

Induction Category Choice:

- **Minimum Port Area (per valve):** 2.0-in²; then find the area that makes peak power.

You will see power decrease with the larger minimum intake area of 2.0-in². Now decrease the area in 0.1-in² steps until you locate a size that produces optimum power (you can switch to the table display to view the exact power values; click **Table** in the *Selection Tabs* at the bottom of the graphs).

You should find that optimum power occurs at about 1.60-in². The power should be about 430-hp at 5500-rpm. Notice how the power drops on either side of the optimum value. This indicates that a port that is either too small or too large for the current port flow and cam timing will reduce engine power.

- 18) Let's modify the **Port Entry Area** from its current value of 3.0-in². This area is the *maximum* port cross-sectional area, located where the port begins inside the intake manifold plenum or where it opens to the atmosphere with individual-runner (or injector) stacks.

Induction Category Selection:

- **Port Entry Area:** 5.0-, 4.0-, 2.0-, and 1.75-in²; then find the area that generates what you consider to be the most usable power curve.

As the *Port Entry Area* decreases (lower numerical values), the port taper angle also decreases, tuning the runner/manifold to a lower rpm. A reduced taper angle (port expands less from valve to manifold) tends to boost peak torque and reduce peak power. Larger Port Entry Areas typically tune the engine for higher rpm, boosting horsepower at the expense of mid-range torque.

Did you locate a port area that produces a good compromise between torque and horsepower? Taper angles of about 3.0- to 5.0-degrees often provide a good compromise (the optimum taper angle will vary depending on the usable rpm range of the engine).

Overview: Cylinder heads with intake ports that are too big or too small do not allow the engine to reach peak performance. In a few minutes of testing, you

Five-Minute, Engine-Buildup Tutorial

have discovered this fact and explored optimum port shapes that can, otherwise, take weeks of work and thousands of dollars to discover!

- 19) Next, let's explore how **Runner Length** further tunes the engine power band. Increase the current runner length from 10.5-inches to 18-inches and, then, shorten it to 6-inches. Watch the power and torque shift up and down the rpm range.

Induction Category Selection:

- **Runner Length:** *Increase to 18-inches, shorten to 6-inches, then return to 10.5-inches.*

As runner length increases, pressure-wave tuning is altered so that the returning *positive pressure intake wave* (the GREEN pressure wave on the center graph) arrives at the intake valve just before valve closing, when the piston is moving **up** in the cylinder). This helps prevent intake back-flow (reversion) into the intake manifold, boosting low-speed power. This phenomenon is visible on both the center (pressure) and lower (velocity) graphs. On the other hand, with runner lengths shorter than about 10-inches, intake pressure-pulse tuning moves to engine speeds too high to be of much use on this basic street engine. For this test engine, 10.5-inch intake runners have a practical length and are close to optimum. Reset to the following values and we'll try some exhaust tuning:

Induction Category Selection:

- **Runner Length:** *Return to 10.5-inches.*
- **Minimum Port Area (per valve):** *1.60-in².*
- **Port Entry Area:** *3.0-in².*

Then set the current engine design as the new baseline.

RPM-Based Graph Option (right-click menu):

- **QuickCompare™:** *Make From Current Test*

- 20) There is a lot more we could explore in intake tuning (such as valve sizes, port flow, modifications to valve timing, and more), but for this introductory tutorial, let's have a look at the exhaust system. Currently, header primary plumbing is constructed from 36-inch long, 1.5-inch diameter tubing and the collectors are 18-inches long and 3-inches in diameter.

First try increasing the *Primary Inlet Diameter* and *Exit Diameter* to 2-inches.

Exhaust Category Selections:

- **Primary Inlet Diameter:** *2.0-inches (Note: Dynomation will not allow the pri-*

Five-Minute, Engine-Buildup Tutorial

mary pipe inlet to be larger than the outlet. So, after you enter 2.0-inches for the Inlet, the program will display a message box and, when you click **OK**, the **Exit Diameter** will be set to the same larger size).

- **Primary Exit Diameter:** 2.0-inches

This boost in peak power (primarily from a reduction in exhaust restriction), comes at the expense of a drop in torque below 4000rpm. Torque is lower due to reduced exhaust scavenging from lower wave pressures within the tubing. The weakened returning negative pressure wave provides less assistance to exhaust flow just before EVC. This increases cylinder pressure near EVC, and higher cylinder pressure presents an increased restriction to intake flow.

- 21) Seems like that was one small step forward and one step backward! How can we regain low-end torque while maintaining higher-rpm power output? The secret lies in harnessing the same phenomenon that is responsible the loss: *Exhaust Pressure Waves*. By installing an exhaust system that returns stronger negative pressure pulses, we can reduce cylinder pressure, and regain lost intake flow.

Let's try installing a header configuration with a reputation for helping low rpm torque and higher rpm horsepower at the same time: a Tri-Y design. Before we do, reset the baseline one more time to make it easier to see the resulting changes:

RPM-Based Graph Option (right-click menu):

- **QuickCompare™:** *Make From Current Test*

Exhaust Category Selections:

- **WA Exhaust Type:** *Tri-Y With 2 Collectors and 1-Step Primary*
- **Primary Length:** *15-inches*
- **Primary Inlet Diameter:** *1.5-inches*
- **Primary Exit Diameter:** *1.5-inches*
- **Secondary Length:** *20-inches*
- **Secondary Inlet Diameter:** *1.875-inches*
- **Secondary Exit Diameter:** *1.875-inches*
- **Collector One Length:** *6-inches*
- **Collector One Inlet Diameter:** *2.50-inches*
- **Collector One Exit Diameter:** *2.50-inches*
- **Collector Two Length:** *10-inches*
- **Collector Two Inlet Diameter:** *3.50-inches*
- **Collector Two Exit Diameter:** *3.50-inches*

The Tri-Y design of multiple, size-step collectors (and the primary pipe size-step) sends a series of scavenging pulses back to cylinders that reduce cylinder pressures and improve intake flow. Because of this, we were able to use a

Five-Minute, Engine-Buildup Tutorial

larger secondary pipe (that reduces exhaust restriction), while maintain cylinder scavenging at lower engine speeds. The result: nearly the same hp we obtained with the larger 2-inch primary pipes and the same torque we achieved with the original 1.5-inch headers.

Note: The pipe dimensions used for this Tri-Y header were obtained by experimentation. You can probably find an even better combination than we did. Give it a try!

The engine configuration at this point was saved as *FiveMinuteTutorial_Step21.dxml*).

- 22) We have only just scratched the surface of engine development using this simulation. There are literally thousands of additional possibilities you can explore in Dynomation6. The information presented in this User Manual, starting with the next Chapter on *Component Menus*, will help you get the most from your software investment.
- 23) Before this tutorial ends, generate a *ProPrint™* report for this simulation: Select **ProPrint Preview** from the *FILE* menu. This will generate a comprehensive *ProPrint™* report and load it into your default Internet browser. Use the scroll bar or page down keys in your browser to move through the report.

You can also send the document to your printer by selecting **Print** from your browser's *File* menu.

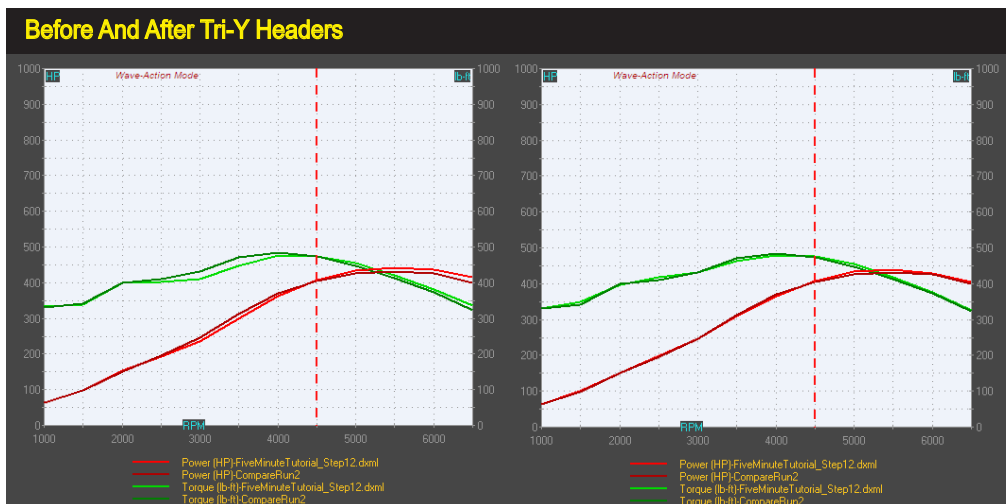

The left screen shows engine output after Step 20, before adding Tri-Y headers. Note the dip in mid-range torque with conventional headers. With a Tri-Y design, the engine regained the lost torque and maintained nearly all peak power.

Five-Minute, Engine-Buildup Tutorial

ProPrint™ Report



Motion Software, Inc.
222 South Raspberry Lane
Anaheim, CA 92808-2268
Fax: 714-974-5389
www.MotionSoftware.com

Numeric UNITS Are Selected
In Dynamation6

Test Engine: FiveMinuteTutorial-Step19.dxml

Simulation Model Specs

Simulation Model Used: Wave Action

Start RPM: 1000

Finish RPM: 6500

Step RPM: 500

Wave Action Mode: Normal

Filling & Emptying Integration:

Atmospheric Standard: J1349, Dym-6 Std

Altitude: 641.7 ft

Air Temp: 77.00 deg F

Humidity: 0.0 %

Barometer: 29.23 inHg

Air Density: 0.07221 lbm/ft^3

Correction Application: Calculated Value

Correction Factor: 1.00000

Engine Shortblock Specs

Short Block: Chevy 350

Number Of Cylinders: 8

Bore: 4.000 in

Stroke: 3.484 in

Rod Length: 5.700 in

Rod Ratio: 1.636

Pin Offset: 0.000 in

Cylinder Swept Volume: 717.45 cc

Total Displaced Volume: 350.2 ci

Cylinder Head Specs

Description: 2-Valve, Wedge, HP/Stock Ports And Valves

Intake Valves Per Port: 1

Exhaust Valves Per Port: 1

Intake Valve Diameter: 1.940 in

Exhaust Valve Diameter: 1.500 in

Induction Specs

Induction: Simple Plenum Model

Runner Temp: 180.00 deg F

Basic Induction Type: Common Plenum

WA Plenum Volume: 100.0 ci

Overall Induction Flow: 650.00 Cfm

@ 1.50 inHg

WA Runner Bellmouth: Not Used

Wave-Action Runner Length: 10.500 in

WA Runner Taper Angle: 1.3 Deg

WA Runner Entry Area: 2.00 sqin

WA Minimum Port Area: 1.45 sqin

Forced Induction Type: None

Number of Turbos:

Turbine A/R Ratio

Turbine Size:

Blower Drive/Belt Ratio:

Intercooler Efficiency:

Blower Internal Ratio:

IC Pressure Drop

Maximum Boost Pressure:

Copyright 2017 to present by Motion Software, Inc. All rights reserved. In no event will Motion Software, Inc. be liable for any direct, indirect, special, or consequential damages, including but not limited to personal injury or other damages, arising out of the use of this program and/or the information therefrom.

This is just one of 17 pages included in the simulation ProPrint™ report. Keep this comprehensive analysis for your records or present to your customers with your engine buildups.

Additional information about *ProPrinting*™ is provided later in this manual.

- 22) Finally, Motion Software, Inc., our version 6 software developers would like to thank you for following along with this tutorial. Any comments are welcome; contact us a support@motionsoftware.com.

Wave-Action Filling & Emptying Simulations Version 6

COMPONENT MENUS

THE SIMULATION COMPONENT CATEGORY

The **SIMULATION Category** is located at the top of the Component Selection Screen. Use this category to select the **Wave-Action**, **Filling-And-Emptying**, and **Hybrid-Sim™** models (*Dynamation6* offers all three models, while *DynoSim6* runs the Filling-And-Emptying model only). These are the various mathematical simulation techniques incorporated into this simulation. Other selections in this category establish a range of rpm values over which the simulation will calculate engine output. Ambient atmospheric conditions under which the dyno test will be simulated are also set in the SIMULATION category.

Dynamation6 incorporates two distinct engine-simulation mathematical models: 1) A **Filling-And-Emptying (FE)** simulation that provides fast mathematical solutions to engine physics, including port- and induction-flow calculations and simplified intake- and exhaust-manifold/runner modeling, making the **Filling-And-Emptying** model an easy way to “ballpark” engine designs with good accuracy, and 2) A full **Wave-Action (WA)** simulation that accurately predicts the complex pressure-wave dynamics and particle flows in intake and exhaust ducting. The **Wave-Action** model picks up where the **Filling-And-Emptying** model leaves off and “homes in” on the best port sizes, shapes, runner lengths, header-tubing sizes, cam timing, valve motion, and much

Simulation Selection

Simulation

Wave-Action Model Filling/Emptying Model Hybrid-Sim Model

Simulation Accuracy And Range Setup

FE Integration: Converge Wave-Action Mode: Normal Start RPM: 1000
Wave-Action RPM Step: 500 Finish RPM: 12000

Environment

Atm Standard: J1349, Dym-6 Std Altitude: 641.7 ft Air Temp: 77.00 deg F
Air Density: 0.07221 lbm/ft³ Barometer: 29.23 inHg Humidity: 0.0 %

Calculated Value Manual Entry Dyno Correction Factor: 1.00000

The **Simulation Category** let's you select the simulation model. The **WA** is ideal for detail engine design, revealing port flow and pressure waves. Use the **FE** for analysis that does not focus on runner dimensions. A **Hybrid** selection combines the results of both simulation models.

Simulation Category

Simulation Setup

Simulation

Wave-Action Model Filling/Emptying Model Hybrid-Sim Model

Simulation Accuracy And Range Setup

FE Integration: Converge Wave-Action Mode: Normal Start RPM: 1000
Wave-Action RPM Step: 500 Finish RPM: 12000

Environment

Atm Standard: J1349, Dym-6 Std Altitude: 641.7 ft Air Temp: 77.00 deg F

Air Density: 0.07221 lbm/ft³ Barometer: 29.23 inHg Humidity: 0.0 %

Calculated Value Manual Entry Dyno Correction Factor: 1.00000

The *Simulation Category* also includes menu choices for the *Start Rpm*, *Finish Rpm*, and *Step Rpm* used during the simulation. The *Wave-Action Mode* choice defines the “depth” or rigor for WA simulation calculations, and the *Environment* section establishes the Standards used for atmospheric correction.

more, providing unprecedented accuracy for detailed engine analysis.

Dynomation6 seamlessly integrates these two simulation technologies. Simply select the model you wish to use with the “radio-buttons” in of the *Simulation Category*. Immediately all component categories will be verified for completeness (based on the selected simulation model), and if all required components and specifications have been entered and are within program limits, the **red-tone** component-category *Title Bars* will switch to **dark-tone**, indicating that the simulation will be performed and the results will be displayed in the graphs and the tables.

Which Simulation Model?

Generally, if you need to quickly determine how an engine will respond to cam timing changes, specific intake manifolds, open-headers vs. mufflers, or you don't have access to all the required intake and exhaust port dimensions for the WA model, the *Filling-And-Emptying* simulation provides a quick and remarkably accurate way to build up and test an engine. However, if you are “digging into” the details of mass flow, port shapes and lengths, and exhaust tubing dimensions, the *Wave-Action* model is required.

FE Note: While the *Filling-And-Emptying* model does use port-flow data, it does not resolve changes in port dimensions. As a result, it may predict somewhat higher power than the WA model since it assumes optimum port dimensions are always used. By carefully tuning runner lengths and exhaust tubing dimensions in the WA, simulation results should match reasonably closely, especially when engine design is more-or-less “standard.” However, if you are modeling exotic engine designs, you should use the *Wave-Action* model whenever possible.

Both simulation models display port pressures and velocities throughout the 720-degrees of crankshaft rotation during the 4-stroke process. This data is displayed in graphs and tables and can help you make decisions about engine tuning (en-

Simulation Category

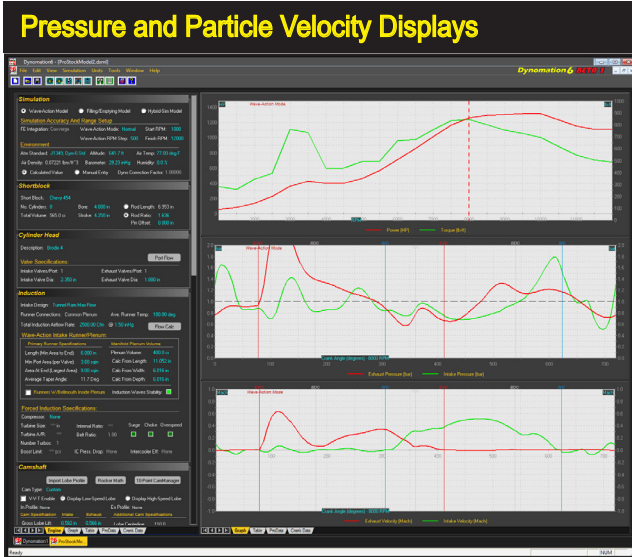

The simulation displays port pressure and velocity curves for the entire 720-degrees of crank rotation of the 4-stroke process (shown in the middle and lower graphs). This data can help you make critical decisions about valve-event timing and intake/exhaust tuning. The WA sim performs a much more rigorous analysis of engine flows, and its displayed pressure waves should be considered a more accurate representation of engine pressure-wave dynamics.

gine tuning is discussed in-depth later in this manual). However, keep in mind that pressure/velocity data calculated by the Wave-Action simulation is derived through a much more rigorous mathematical approach and should be considered the most accurate representation of actual engine pressure-wave dynamics.

WA Note: In cases where you have sufficient test data for the Wave-Action model, but you would like to test a restrictive exhaust system, you can reduce the *Minimum Exhaust Port Area* (by about 30% for typical mufflers) to simulate backpressure in the exhaust system. For detailed information about wave-dynamics and pressure-wave tuning, refer to the **Wave-Dynamics Analysis** chapter later in this User Guide.

FE and WA Simulations: “Cycles” And Convergence

Both the WA and FE simulation models perform an analysis of the gas-exchange process within engine passages. These processes are dependent on valve position, piston position, engine speed, and much more. To ensure that these mathematical processes have reached a “steady-state” condition, several cycles may be necessary. These “cycles” should not be confused with engine cycles; rather they represent the number of times the simulation model must work through a gas-dynamics analysis to reach the *same* results, or stability. In some ways, this phenomenon is similar to the instability often seen in real-world dyno tests just before the engine “smooths out” at the measurement rpm. Some of this instability is due to the same gas-dynamic effects calculated within the simulation.

In previous versions of this software, you were required to select the number of

Simulation Category

calculation “cycles.” Often this required entering a number that would ensure stability (also called *convergence*) but could allow the simulation to run more cycles than necessary, extending calculation times. In Dynomation6, the number of simulation cycles is determined automatically during the calculation process. In most cases, a steady-state condition will be reached in 4 to 6 cycles. However, in some drag-racing or very-high-rpm race engines, it may require as many as 10 or more cycles to stabilize gas dynamics.

In the FE simulation (and in *DynoSim6*), you can chose to run the simulation in the single-pass mode (without convergence), which was the default in previous program versions. Alternatively, you can select **Converge** (*the default mode*), allowing the FE to run until it finds gas-dynamic stability. An *Extended Converge* mode is also available specifically for high-output racing engines. If you enable either *Converge* modes in the FE, the calculation times will usually double or triple. The FE *Converge* mode almost always improves accuracy (in the WA model, as mentioned in the previous paragraph) the simulation always runs to convergence.

The number of calculation cycles for both simulations is displayed in the *Simulation Log* (open the Log using the *Simulation Menu*, located at the top of the program screen).

Wave-Action Only: Simulation “Meshing”

The Wave-Action simulation calculates gas-dynamics within engine passages by dividing the intake and exhaust passages into small, equal-size volumes, called meshes (this is not performed in the FE simulation). The smaller the mesh size, the greater number of mesh volumes into which the passage volumes will be divided. This can improve simulation accuracy, but at the expense of calculation times, since a larger number of mesh volumes require a more complex mathematical analysis.

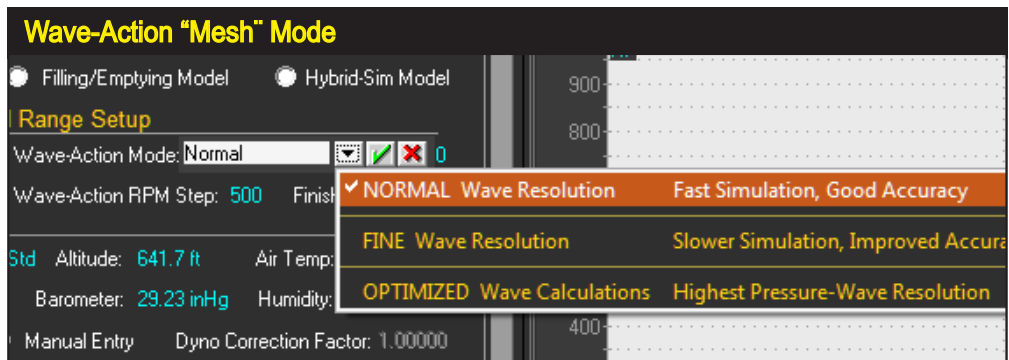

The Wave-Action simulation calculates gas-dynamics by dividing the intake and exhaust passages into small volumes, called meshes. Smaller mesh sizes can improve simulation accuracy, but at the expense of calculation times. The *Normal* mesh is usually sufficient to accurately analyze gas dynamics and provide good simulation accuracy.

Simulation Category

The Wave-Action simulation incorporates three mesh sizes selected from the **Wave-Action Mode** field: **Normal**, **Fine** and **Optimized**. In most cases, the **Normal** mesh size is sufficient to accurately analyze gas dynamics within intake and exhaust passages. But, in some cases, a more rigorous analysis is required to overcome instabilities, shock waves in the exhaust runners, or odd pressure-wave interactions. For example, if you notice a pressure spike or oscillation in the intake or exhaust pressure curve close to TDC, it may be an anomaly that will “disappear” with the more rigorous analysis offered in the **Fine** and **Optimized** modes. However, lacking pressure-trace anomalies or other unusual displays, the **Normal** level of mesh will provide good simulation accuracy.

Note: The **Fine** mode takes about three times longer than **Normal** to complete the simulation. And the **Optimized** selection directs the sim to not only use the smallest mesh size possible, but also to use the most detailed calculations for engine physics. For **Optimized**, processing time is not a factor, and it usually takes about 20 times longer to complete simulation calculations. In almost all cases, this option is not required to produce accurate results, and in fact, the differences between **Fine** and **Optimized** are often barely visible on the results graphs.

FE and WA Simulations: RPM Ranges And Atmospheric Standards

The Simulation Category also includes fields to specify the rpm range for the simulation (**Start & Finish RPMs**). The narrower the range, the faster the simulation is performed. If you are using a supercharging system, and it's developing errors at higher engine speeds (like *overspeed* or *choke*), you can reduce the upper rpm limit to help prevent these errors. In addition, if you are running an *Iterative Test* (see the Quick and Pro Iterator chapters later in this User Guide), keeping the RPM range as narrow as possible will substantially reduce testing time.

Set ambient conditions (or Standards) for the simulation by selecting one of the built-in models in the *Atmospheric Standard* menu. You can apply SAE, ISO, and other world standards commonly used for dynamometer testing. The default used in Dynomation6 and DynoSim6 is different from Dynomation5/DynoSim5, and is based on the SAE J1394 v3 standard widely used in modern dyno test facilities. The available Standards are:

• Standard Atmosphere:	Temp (F): 59.0	Humidity: 0%	Barometer(in): 29.921
• AE J606/7:	Temp (F): 60.0	Humidity: 0%	Barometer(in): 29.921
• ISO 1585:	Temp (F): 60.0	Humidity: 0%	Barometer(in): 29.530
• JIS D 1001:	Temp (F): 68.0	Humidity: 0%	Barometer(in): 29.234
• Dynomation-5 Standard:	Temp (F): 68.0	Humidity: 0%	Barometer(in): 29.919
• SAE J1349 v3, Ver-6 Std:	Temp (F): 77.0	Humidity: 0%	Barometer(in): 29.234
• SAE J1394 v1:	Temp (F): 77.0	Humidity: 0%	Barometer(in): 29.318
• SAE J1394 v2:	Temp (F): 77.0	Humidity: 0%	Barometer(in): 29.380

Simulation Category

- SAE J1394 v3: Temp (F): 77.0 Humidity: 0% Barometer(in): 29.234
- SAE J1995: Temp (F): 77.0 Humidity: 0% Barometer(in): 29.530

In addition to the standards available in the menu, you may enter any **Altitude**, **Air Temperature**, **Barometer**, and **Humidity** value you wish. The changes in environmental variables are applied to the simulation through a “correction factor.” This value is normally calculated by Dynomation after you make a menu selection or enter specific atmospheric values. However, you can click **Manual Entry** and directly enter any correction factor you wish.

ShortBlock Category

Short Block Component Menu

Shortblock
 Short Block: Honda 2.2L
 No. Cylinders: 4 Bore: 3.388 in Rod: []
 Total Volume: 134.7 ci Stroke: 3.740 in Pin C: []

Cylinder Head
 Description: Stock F20 S2000

Valve Specifications:
 Intake Valves/Port: 2 Exhaust Valves/Port: []
 Int Valve Test Dia: 1.299 in Exh Valve Run Dia: []
 Int Valve Run Dia: 1.300 in Exh Valve Run Dia: []

Induction
 Intake Design: Simple Plenum Model
 Runner Connections: Common Plenum Ave. Runner Temp: 180.00 deg
 Total Induction Airflow Rate: 1200.00 Cfm @ 1.50 inHg [Flow Calc]

Wave-Action Intake Runner/Plenum:

Primary Runner Specifications		Manifold Plenum Volume	
Length (Min Area to Entry):	9.500 in	Plenum Volume:	100.0 ci
Min Port Area (per Valve):	1.00 sqin	Calc From Length:	6.962 in
Port Entry Area (Max Area):	2.00 sqin	Calc From Width:	3.790 in
Average Taper Angle:	2.8 Deg	Calc From Depth:	3.790 in

Bellmouth Not Available On FE Sim Induction Waves Stability

Forced Induction Specifications:
 Compressor: Turbo-Garett-GTX3071R-71-58
 Turbine Size: 2.800 in Internal Ratio: 1.00 Surge Choke Overspeed
 Turbine A/R: 0.70 Belt Ratio: 1.00

Select Engine Manufacturer >
 American
 Australian
 British
 French
 Japanese
 German
 Italian
 Swedish
 South Korea - Kia
 Custom

Engine Selection Table:

Manufacturer	Cylinder	Bore (in)	Stroke (in)	Deflt Rod Ratio
Honda	4 Cylinder	1.2L	(2,760 bore/2,990 stroke)	
Hyundai	6 Cylinder	1.3L	(2,830 bore/3,230 stroke)	
Infiniti		1.5L	(2,953 bore/3,327 stroke/deflt rod ratio)	
Infiniti		1.6L	(2,950 bore/3,540 stroke)	
Isuzu		1.6L	(2,953 bore/3,543 stroke/1,522 rod ratio)	
Lexus		1.6L	(3,189 bore/3,047 stroke/1,732 rod ratio)	
Mazda		1.7L	(2,950 bore/3,700 stroke)	
Mazda		1.8L	(3,030 bore/3,700 stroke)	
Mitsubishi		1.8L VTEC	(3,189 bore/3,433 stroke/1,581 rod ratio)	
Mitsubishi		1.8L VTEC	(3,209 bore/3,433 stroke/1,581 rod ratio)	
Nissan		2.0L	(2,953 bore/3,543 stroke/deflt rod ratio)	
Subaru		2.0L	(3,260 bore/3,580 stroke/deflt rod ratio)	
Suzuki		2.2L	(3,386 bore/3,740 stroke/1,490 rod ratio)	
Suzuki		2.2L	(3,425 bore/3,571 stroke/1,577 rod ratio)	
Toyota		2.3L	(3,445 bore/3,740 stroke/1,490 rod ratio)	
Toyota		2.3L	(3,390 bore/3,820 stroke/deflt rod ratio)	

Graphs:
 Top: Power (HP) vs RPM (0-14000). Legend: StockHondaS2000turboTest.dml (red), Boost Pressure (psi)-StockHondaS2000turboTest.dml (green).
 Middle: Filling/Emptying Mode vs RPM (0-14000). Legend: EDC, VQ, EDC, VQ.
 Bottom: Pressure vs RPM (0-14000). Legend: EDC, Filling/Emptying Mode.

The **Short Block** component menu contains over 500 bore and stroke combinations of popular domestic and import engines that you can instantly use in any engine simulation. In addition, you can directly enter a custom description of any engine into the **Short Block** component field.

THE SHORBLOCK COMPONENT CATEGORY Applies To Both the FE and WA Simulations

The **ShortBlock** menu is located in the **Shortblock Component Category**. By opening this menu, you are presented with a variety of domestic and import “predefined” shortblock configurations. If any one of these choices is selected, the appropriate bore, stroke, number of cylinders, rod ratio, and pin offset (see entering **Rod Ratio**, **Rod Length And Pin Offset**, next) will be loaded into the **ShortBlock** category. In addition to the predefined shortblocks in the menu, you can directly enter any shortblock name (description) into the **ShortBlock** field, then enter custom values for **Stroke**, **Bore**, **Number Of Cylinders** (also **Rod Ratio** and **Piston Pin Offset**) within the acceptable range limits of the program (as indicated at the range limit line at the bottom of the screen).

Note: The **Short Block** menu can be considered a “handy” list of common engine bores, strokes, rod-length and offset values. When you select a shortblock, you are not selecting any “hidden” characteristics, like material composition (alumi-

ShortBlock Category

ShortBlock Component Menu

Shortblock

Short Block: Honda 2.2L
No. Cylinders: 4 Bore: 3.386 in Rod Length: 5.573 in
Total Volume: 134.7 ci Stroke: 3.740 in Rod Ratio: 1.490
Pin Offset: 0.000 in

Rod Length & PinOffset:

Note: Rod Ratio will default to 1.636 if actual value is not available in the Short Block menu.

Pin Offset is set to 0.000-inch for all engines loaded from menu.

The *Short Block* component menu (shown on previous page) contains over 500 bore and stroke combinations. Many selections also include rod-ratio, however if this data is not available, a default value of 1.636 is used. Pin offset specifications are set to 0.000-inch for all engines loaded from the Short Block menu.

num vs. cast iron) or other component assumptions (such as typical cylinder head type). The **Short Block** menu only loads the *Bore*, *Stroke*, *Rod Ratio*, *Pin Offset*, and the *Number Of Cylinders* into the simulation.

Entering Rod Ratio, Rod Length And Piston-Pin Offset

In addition to the *Bore*, *Stroke*, and *Number Of Cylinder* specifications, **Short Block** menu selections will load the **Rod Ratio** (or if unavailable, a default value of 1.636 will be used). The **Rod Ratio** is the length of the connecting rod divided by the stroke length and is commonly used to evaluate rod angularity and piston-to-cylinderwall friction, the single greatest source of frictional losses within the engine.

You may also manually enter values for *Rod Length* or *Rod Ratio* within program range limits (displayed at the bottom of the screen in the status bar). To enter *Rod*

The Piston-Pin Offset is a measure of how far off-center the piston pin is located within the piston. The simulation models these changes in pin offset when you enter positive values for a pin location shifted toward the *Major Thrust Face* and negative values (for offsets toward the *Minor Thrust Face*).

Piston-Pin Offset Values

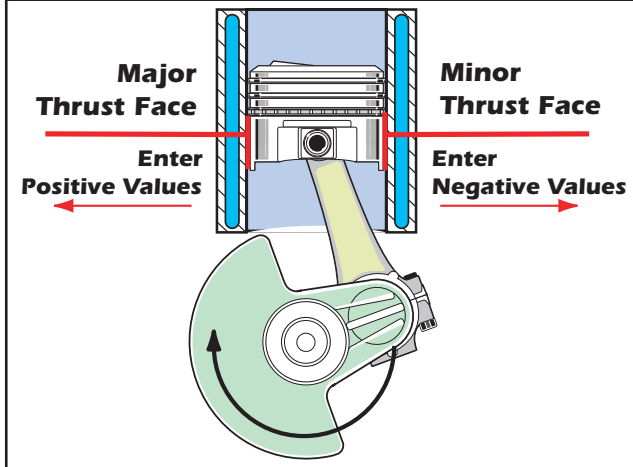

ShortBlock Category

Ratio, select the “radio” button next to the **Rod Ratio** field, then enter the desired value. the simulation will display the calculated value for **Rod Length**. Or, by selecting the **Rod Length** radio button, you can directly enter a length value; *Rod Ratio* will then be calculated and displayed in the **Rod Ratio** field.

The **SHORTBLOCK** category also includes a field for **Piston-Pin Offset**. This is a measure of how far off-center (from the rod-to-crank centerline) the piston pin is located within the piston. Enter positive values to indicate a shift toward the *Major Thrust Face* and negative values to shift the pin toward the *Minor Thrust Face*.

Note: *Piston-Pin Offset* is set to 0.000-inch for all engines loaded from **Short-Block** menu.

ShortBlock Category

Cylinder-Head Category

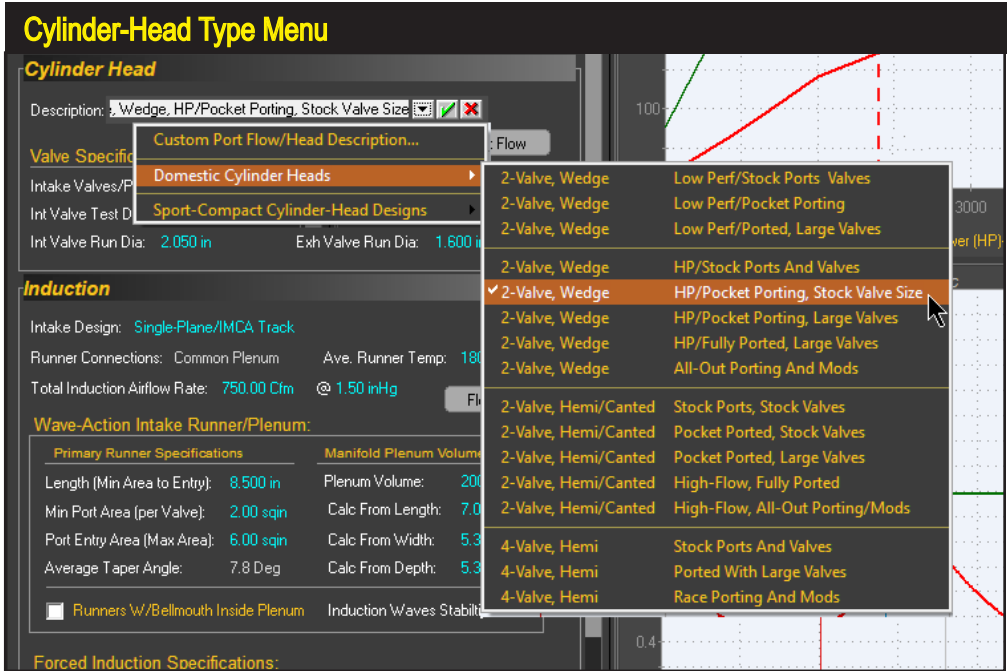

The *Cylinder Head Type (Description)* menu contains a wide range of head/port choices. The main menu is divided into two groups: *Domestic Cylinder Heads* model typical 4-cylinder through V8 passenger car engines. The *Sport-Compact Cylinder Heads* selections primarily model newer, multiple-valve-per-port head designs.

THE CYLINDER-HEAD COMPONENT CATEGORY Applies To Both the FE and WA Simulations

The **Cylinder-Head Type** pull-down menu is located in the **CYLINDER HEAD** category. Selections from this menu allow the simulation to model various intake and exhaust port airflow characteristics for both *Domestic* and *Sport-Compact* applications. Built-in selections range from restrictive low-performance ports to high-performance four-valve cylinder heads. Each grouping of head/port designs includes several stages of modifications.

In addition to the provided choices, the **Custom Port Flow** selection at the bottom of the *Cylinder Head Type* menu lets you directly enter flowbench data, allowing the simulation to model any cylinder head for which airflow test data is available (for convenience, a **Port Flow** button in the *Cylinder Head* category provides fast access to the same custom-airflow, data-entry dialog). Custom port flow data entry will be detailed after the following brief descriptions of the “generic” menu choices.

Valve Diameters And Basic Flow Theory

A selection from the *Cylinder Head* menu is the first part of the process that

Cylinder-Head Category

Selecting a specific valve size fixes the theoretical peak flow of each port. Cylinder heads flow from about 50% to as high as 90% of this value. This percentage, called the *discharge coefficient*, has proven to be an effective link between flow-bench data and the calculation of mass flow moving into and out of the cylinders. In other words, the valve size and the derived discharge coefficient help establish a practical framework to accurately simulate mass flow within a running engine.

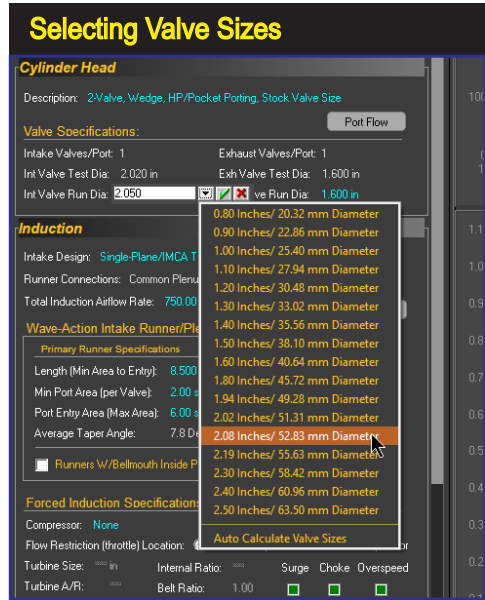

establishes a baseline for the simulation of cylinder-head airflow. A *Cylinder-Head Description* selection (or entering *Custom Port Flow* values) dictates the airflow restriction generated by the valves and ports. That is, flow data determines *how much airflow, below the theoretical maximum peak flow for a straight pipe of the same area, will pass through the valve orifice at all valve lift heights*. The percentage of ideal flow is called the *Coefficient of Discharge (CD)* and is always less than 100% (less than 1.0). The CD values are calculated and displayed in the *Port-Flow Dialog* as you enter flow-bench data (described later).

Dynomation6 Only: The *Port-Flow Dialog* also contains a dropdown menu that lets you select alternate methods of calculating CDs and valve flow areas. We recommend that you use the default *Dynomation Method* for most engine analysis, as this algorithm has demonstrated proven accuracy for more than 20 years of engine simulations (for more information on this feature and when to consider using alternate methods refer to **Selecting Alternate Methods To Calculate CDs** at the end of this chapter).

Dynomation6 Only: In Wave-Action simulations, the Intake *MinPortArea* (located in the *Induction Category*) establishes the restriction in the ports and the dimensional characteristics of the intake runners needed for pressure-wave analysis (in Filling-And-Emptying simulations, the optimum minimum area is determined automatically during the simulation process). These restriction values help determine mass flow into and out of the cylinders.

The additional data point needed to characterize overall engine airflow is the

Cylinder-Head Category

Typical Low-Performance Cylinder Heads

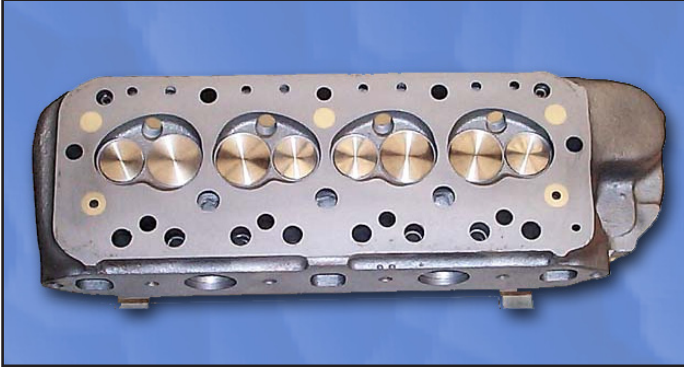

The *Low Performance* cylinder head choices are intended to model cylinder heads that have restrictive ports, valves, and combustion chambers. Heads of this type were often designed for low-speed, economy applications, with little concern for high-speed performance.

Total Induction Airflow Rate (also located in the *Induction Category*). This can be considered the rated flow of the carburetor or throttle plates/valves measured at a specific pressure drop. This establishes an overall flow-rate restriction for entire engine.

When this essential data has been entered, the program is a step closer to determining mass flow within the ports. Unfortunately, the flow in the ports of a running engine is vastly different than the steady-state flow measured on a flow bench. A running engine will generate rapidly and widely varying pressures that directly affect—in fact, they directly cause—the flow of air and exhaust gasses within the engine. To determine the instantaneous flow in all ports at any point during engine operation, the simulation must calculate all internal port and cylinder pressures at closely-spaced, small increments of time throughout the four-cycle process. Overall mass flow into and out of the cylinders is found from the sum of these instantaneous pressures, calculated gas densities, and flow restrictions throughout the runners. After a series of integration operations using this data, engine output and related “dyno” results can be determined. (Not magic, but close!)

Domestic Cylinder-Head Selections

Here is some basic information that will help you determine the appropriate cylinder-head selections (and port flow data) from the built-in menu selections for domestic engine applications.

Note: Each of the generic choices in the Cylinder Head menu has flowbench data associated with it. To view this test data simply select the cylinder head from the menu then click the **Port Flow** button.

Wedge-Chamber, 2-Valve Cylinder Heads

Domestic—2-Valve, Low Performance Cylinder Heads (Three variations: Stock, Ported, and Ported With Large Valves)

There are three **Low Performance** cylinder head selections listed at the top

Cylinder-Head Category

2-Valve, HP Wedge Cylinder Heads

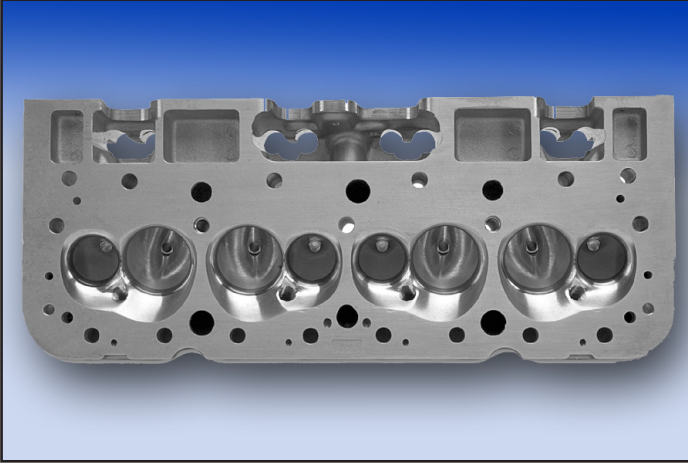

The *2-Valve, HP Wedge Cylinder Head* selections model cylinder heads that have ports and valves sized with performance in mind, like this Edelbrock smallblock Chevy head.

of the **Domestic Cylinder Head** menu. Each of these choices is intended to model cylinder heads that have small ports and valves relative to engine displacement. Heads of this type were often designed for low-speed, economy applications, with little concern for high-speed performance. Early 260 and 289 smallblock Ford and to a lesser degree early smallblock Chevy castings fall into this category. These choices have the lowest discharge coefficient of all the head configurations listed in this menu. Minimum port cross-sectional areas are approximately 60% of the valve areas, and if **Auto Calculate Valve Size** has been selected, relatively small (compared to the bore diameter) intake and exhaust valve diameters will be selected.

Note: These low-performance cylinder-head choices are a good option if you wish to model flathead (L-head & H-head) and hybrid (F-head) engines for which you do not have actual flow data. While the port flow in these engines is quite restrictive, by selecting **Low-Performance** and manually entering the actual valve sizes, the simulation will provide a good approximation of power output from these early engine designs.

Domestic—2-Valve, Wedge Cylinder Heads (Three Variations: Stock, Ported, Large Valves)

The first three wedge cylinder-head selections model castings that have ports and valves sized with performance in mind. Ports are only somewhat restrictive for high-speed operation, and overall port and valve-pocket design offers a good compromise between low restriction and excessive flow velocity at higher engine speeds. The stock and pocket-ported choices are applicable to high-performance street to modest racing applications.

Domestic—2-Valve, Wedge/Fully Ported, Large Valves

The fourth wedge head moves away from street applications. This casting has improved discharge coefficients, greater port cross-sectional areas, and increased valve sizes. Consider this head to be an modified, high-performance, factory-

Cylinder-Head Category

Typical Canted-Valve Cylinder Heads

The *Canted-Valve Cylinder Head* selections have ports with generous cross-sectional areas and valves that angle toward the port mouths. The first three menu choices model oval-port designs. The final two selections simulate performance rectangular-port heads. This L29 bigblock Chevy would be best modeled by the second or third menu choice—the fourth menu choice models a head with flow capacity beyond the capabilities of L29 castings.

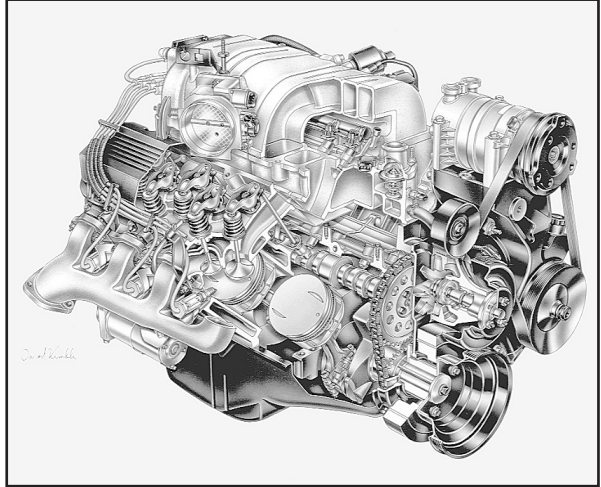

type casting that has good flow for racing applications. It does not incorporate “exotic” alterations, like raised and/or welded ports requiring custom-fabricated intake manifolds.

Domestic—2-Valve, Wedge/ProStock Porting And Mods

The last choice in the wedge group is designed to model high-flow, professional drag-racing cylinder heads. These heads are designed for one thing: Maximum power. They usually require hand-fabricated intake manifolds, have high valve discharge coefficients, and the ports have the largest cross-sectional areas in the smallblock group. This head develops sufficient airflow speeds for good cylinder filling only at high engine rpm.

Hemi/Canted 2-Valve Cylinder Heads

The following *Hemi/Canted-Valve* selections are modeled after heads with valve stems tilted toward the inlet or discharge surfaces of the cylinder heads. This design reduces restriction at the valve, improves CD, and is particularly beneficial at higher engine speeds.

Domestic—2-Valve, Hemi/Canted-Valve Cylinder Heads (Stock, Ported, Large Valves)

The first three choices best model oval-port configurations. These smaller cross-sectional area ports provide a good compromise between low restriction and high flow velocity for larger displacement engines. The stock and pocket-ported choices are suitable for high-performance street to modest racing applications.

The next two selections best model extensively modified rectangular-port heads. These choices are primarily, all-out, bigblock heads, however, they also model

Cylinder Head Category

2-Valve, Hemi, HP Cylinder Heads

The *2-Valve, Hemi, HP Cylinder Head* selections have ports with generous cross-sectional areas and valves that angle toward the port inlets (the Dodge 5.7L Hemi is shown here).

These heads have improved discharge coefficients and their high-performance designs typically offer the highest flow capability for 2-valve cylinder heads. Heads of this type have the greatest potential of producing the highest horsepower within the first three groups in the *Cylinder Head Type* menu.

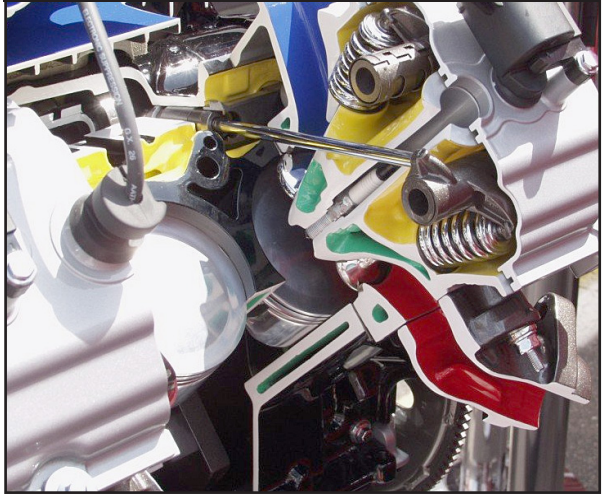

other aggressive, high-performance designs, like the Chrysler Hemi head.

Domestic—2-Valve, Hemi/Canted-Valve, Rectangular Ports/Fully Ported

These rectangular-port heads have high discharge coefficients, large port cross-sectional areas, and increased valve sizes. This head is basically a factory-type casting but extensively improved. However, it does not incorporate “exotic” modifications, like raised and/or welded ports that require custom-fabricated manifolds.

Domestic—2-Valve, Hemi/Canted-Valve, Rectangular ProStock Ports/Mods

The last choice in the *Hemi/Canted-Valve* group is designed to model state-of-the-art, ProStock (and Hemi) drag-racing cylinder heads. These custom pieces, like their wedge-design counterparts, are more-or-less built from the ground-up for maximum power. They require custom-fabricated intake manifolds, have optimum valve discharge coefficients, and the ports have the largest cross-sectional areas in the entire 2-valve **Cylinder Head** menu. These specially fabricated cylinder heads only develop sufficient airflow for good cylinder filling with large displacement engines at high engine speeds.

Domestic 4-Valve Cylinder Heads

The next three selections in the **Domestic Cylinder Head** submenu model 4-valve cylinder heads. These are very interesting choices since they simulate the effects of very low-restriction ports and valves used in many current high-performance applications. The individual ports in 4-valve heads begin as single, large openings, then divide into two Siamesed ports, each having a small (relatively) valve at the combustion chamber interface. Since there are two intake and two exhaust valves per cylinder, the valve flow area exposed as the valves lift off the seats (called

Cylinder Head Category

Two-Valves-Per-Port Cylinder Head

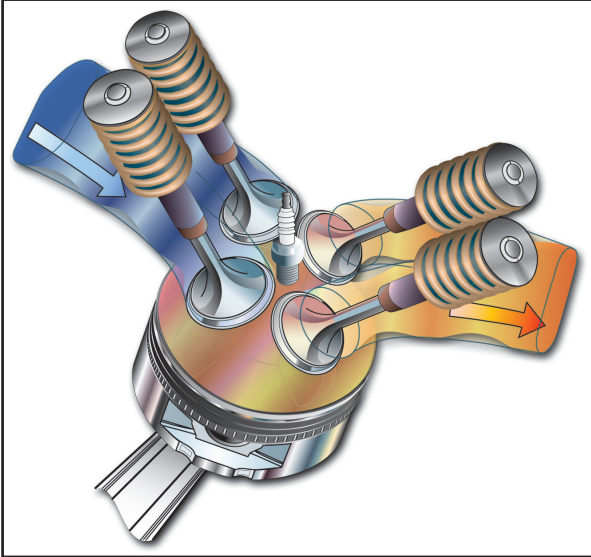

The *4-Valve Cylinder Head* selections model cylinder heads with two intake and two exhaust valves per cylinder. These heads can offer more than 1.5 times the curtain area of the largest 2-valve heads. This large valve flow area, combined with high-flow, low-restriction ports greatly improves air and fuel flow at higher engine speeds.

curtain area) is considerably greater than in the largest single-valve-per-port designs. In fact, 4-valve heads can offer more than 1.5 times the curtain area of the largest 2-valve heads. This large flow area, combined with high-flow, low-restriction ports, improves air and fuel flow at low valve lifts *and* at high engine speeds. Unfortunately, the ports offer an equally low restriction to reverse flow (reversion of charge from the cylinder back into the intake port) that commonly occurs at low engine speeds when the piston moves up the cylinder from BDC to Intake Valve Closing (IVC) on the early portion of the compression stroke. For this reason, 4-valve heads, even when fitted with more conservative ports and valves, can be a poor choice for small-displacement, low-speed engines, unless camshaft timing is carefully designed to complement the low-lift flow capabilities of these cylinder heads (using, for example, variable-valve timing...V-V-T). On the other hand, the outstanding flow characteristics of 4-valve heads puts them in another “league” when it comes to horsepower potential at high engine speeds.

Domestic—4-Valve, Hemi/Canted-Valve, Stock Ports And Valves

The first choice in the 4-valve group simulates a 4-valve cylinder head that would be “standard equipment” on factory high-performance engines. These heads offer power comparable to high-performance 2-valve castings equipped with large valves and porting work. However, because they still have relatively small ports, reasonably high port velocities, and good low-lift flow characteristics, they can show a boost in low-speed power over comparable 2-valve heads.

Domestic—4-Valve, Hemi/Canted-Valve, Ported With Large Valves

The next choice incorporates mild performance modifications. Larger valves have been installed and both intake and exhaust flow has been increased

Cylinder Head Category

by improved port designs. However, care has been taken not to increase the minimum cross-sectional area of the ports. These changes provide a significant increase in power with only slightly slower port velocities. Reversion has increased slightly, but overall, these heads should show a power increase throughout the rpm range on most engines.

Domestic—4-Valve Hemi/Canted-Valve, Race Porting And Mods

The final choice, like the other *Race-Porting-And-Mod* choices in the **Cylinder Head** menu, models a racing cylinder head. This selection has the greatest power potential. The ports are considerably larger than the other choices, the valves are larger, and the discharge coefficients are the highest possible. These heads suffer from the greatest reversion effects, especially with late IVC timing on small-displacement engines.

Domestic-Engine Simulation Tip: If you would like to know what “hidden” power is possible using any engine combination, try the *4-Valve Hemi/Canted-Valve, Race Porting And Mods* cylinder-head choice. It is safe to say that the only way to find more power, with everything else being equal, would be to use forced induction, nitrous-oxide injection, or exotic fuels.

Sport-Compact Cylinder Head Selections

The first three selections in the **Sport-Compact Cylinder Head Type** submenu model the low-restriction ports and valves used in modern, 4-valve cylinder-heads; the basic mainstay of the Sport-Compact enthusiast. The individual ports in 4-valve heads begin as single, relatively large openings, then neck down to two Siamesed ports, each having a small (relatively) valve at the combustion chamber interface. Since there are two intake and two exhaust valves per cylinder, valve curtain area (area exposed around an open valve through which air/fuel can pass) is consider-

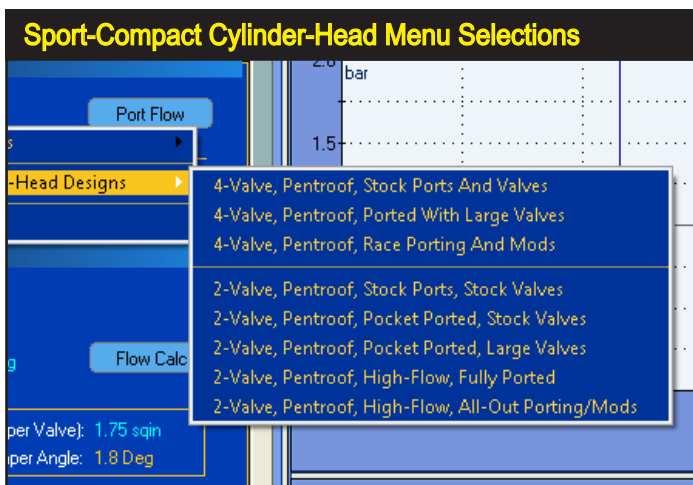

The *Sport-Compact Cylinder Head* selections are divided into two groups. The most common is the 4-Valve type with some version of a pentroof combustion chamber. The second group are 2-Valve heads, having good flow characteristics, but considerably lower power potential than the 4-Valve designs.

Cylinder Head Category

4-Valve, Pentroof, HP Cylinder Heads

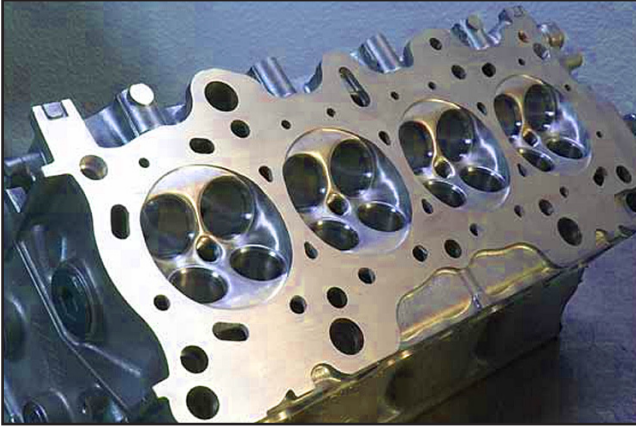

The *4-Valve Cylinder Head* selections model cylinder heads with two intake and two exhaust valves. These heads can offer more than 1.5 times the curtain area of the largest 2-valve heads. This large valve flow area, combined with high-flow, low-restriction ports greatly improves air and fuel flow into the cylinders at high engine speeds.

ably larger than the largest single-valve-per-port designs. In fact, 4-valve heads can offer more than 1.5 times the curtain area of the largest 2-valve heads. This large flow area, combined with the high-flow, low-restriction ports greatly improves air and fuel flow into the cylinders at low valve lifts and high engine speeds. However, the ports offer an equally low restriction to reverse flow (reversion) that can occur at low engine speeds when the piston moves up the cylinder from BDC to Intake Valve Closing (IVC). For this reason, 4-valve heads, even when fitted with more conservative ports and valves, can be a poor choice for small-displacement, low-speed engines, unless camshaft timing and valve lift is carefully designed to complement the flow capabilities of these cylinder heads.

Sport-Compact 4-Valve Cylinder Heads

Sport-Compact—4-Valve, Pentroof, Stock Ports And Valves

Note: Each of the generic choices described below in the Cylinder Head menu

4-Valve Cylinder Heads are commonly used on Import high-performance street engines, like the Variable Valve Timing powerplants installed in many Honda vehicles. These engines offer a level of performance and driveability that is impossible with 2-valve cylinder heads.

Honda VTEC, 4-Valve, Pentroof Engine

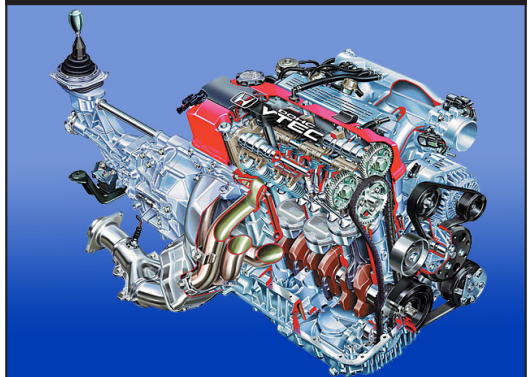

Cylinder Head Category

has flowbench data associated with it. To view this test data simply select the cylinder head from the menu, then click the **Port Flow** button.

The first choice in the 4-valve group simulates a 4-valve cylinder head that would be “standard equipment” on factory high-performance, sport-compact engines. Although excellent for street performance, since they have relatively small ports, reasonably high port velocities, and good low-lift flow characteristics, with proper cam timing they often show a boost in low-speed power over comparable 2-valve heads (and at higher engine speeds, they will outperform all but the most highly modified 2-valve heads).

Sport-Compact—4-Valve, Pentroof, Ported With Large Valves

The next choice incorporates mild performance modifications. Larger valves have been installed and both intake and exhaust flow has increased from improved port designs. However, care has been taken not to increase the minimum cross-sectional area of the ports. These changes provide a significant increase in power with only slightly slower port velocities. Reversion has increased, but overall, these heads will show a power increase throughout most of the rpm range on many engines.

Sport-Compact—4-Valve, Pentroof, Race Porting And Mods

The final choice, like other Racing options in the **Cylinder Head** menu, models a very efficient, high-flowing cylinder head. This selection has the greatest power potential of all sport-compact menu choices. The ports are considerably larger, the valves are larger, and the discharge coefficients are the highest possible. These heads suffer from the greatest reversion effects at lower engine speeds, especially with late IVC timing on small-displacement engines.

Sport-Compact Simulation Tip: If you would like to know what “hidden” power is possible using any particular engine combination, try this cylinder head choice. It is safe to say that the only way to find more power, with everything else being equal, would be to add forced induction, nitrous-oxide injection, or use exotic fuels.

Sport-Compact-Design, 2-Valve Cylinder Heads

The next five choices in the Sport-Compact/Import *Cylinder Head* menu model pentroof-chamber, “canted-valve” heads with one valve per port, each tilted or canted toward the port inlet/discharge surface. This positioning improves discharge coefficients and overall airflow. All ports in this menu group have cross-sectional areas sized for performance.

Sport Compact/Import—2-Valve, Pentroof, HP Cylinder Heads (Stock, Ported, Large Valves)

The first three choices can be considered suitable for street/performance appli-

Cylinder Head Category

cations. These selections model smaller cross-sectional area ports (sometimes oval or round) that provide a good compromise between low restriction and high flow velocity for production engines.

Sport-Compact/Import—2-Valve, Pentroof, High-Flow, Fully Ported

The final two Pentroof, 2-valve selections simulate extensively modified, high-performance cylinder heads. These castings have high discharge coefficients, large port cross-sectional areas, and increased valve sizes. These heads are basically factory-type castings but incorporate improved porting and valve work. However, they do not use “exotic” modifications, like raised and/or welded ports that require custom-fabricated manifolds.

Sport-Compact/Import—2-Valve, Pentroof, High-Flow, All-Out Porting/Mods

The last choice in this group is designed to model state-of-the-art, 2-valve, drag-racing cylinder heads. These custom pieces are extensively modified for maximum power. They require hand-fabricated or custom intake manifolds, have optimum valve discharge coefficients, and the ports have the largest cross-sectional areas of the 2-valve head designs. These cylinder heads only develop sufficient airflow for good cylinder filling at high engine speeds.

Custom Port Flow And The Port-Flow Dialog

The simulation will accept flowbench data from a variety of sources. Basic flow-test data can be directly entered into the *Port Flow* dialog using any valve size, at any

Port-Flow Dialog Data Import

Description: 2-Valve, Wedge, HP/Stock Ports And Valves

Intake Valve

Test Diameter: 2.020 in Valves Per Port: 1
 Pressure Drop: 28.0 inH2O Data Points: 8

	Lift: in	Flow: Cfm	CD:		Lift: in	Flow: Cfm	CD:
1	0.200	134.0	0.75	6	0.600	223.0	0.40
2	0.300	176.0	0.64	7	0.650	227.0	0.37
3	0.400	213.0	0.58	8	0.700	227.0	0.35
4	0.500	219.0	0.47	9	xxx	0.0	xxx
5	0.550	223.0	0.44	10	xxx	0.0	xxx

Exhaust Valve

Test Diameter: 1.600 in Valves Per Port: 1
 Pressure Drop: 28.0 inH2O Data Points: 8

	Lift: in	Flow: Cfm	CD:		Lift: in	Flow: Cfm	CD:
1	0.200	97.0	0.72	6	0.600	131.0	0.30
2	0.300	116.0	0.55	7	0.650	132.0	0.28
3	0.400	125.0	0.44	8	0.700	132.0	0.26
4	0.500	130.0	0.36	9	xxx	0.0	xxx
5	0.550	131.0	0.33	10	xxx	0.0	xxx

Buttons: Open..., Save As..., Calc Others, Reset, **Import Intake**, Import Exhaust, OK, Cancel

Help Text:

You can enter flowbench data from a variety of sources. Open the *Port-Flow Dialog* by clicking the *Port Flow* button in the *Cylinder Head* component category. Basic flow-test data can be directly entered using any valve size at any pressure drop.

Cylinder Head Category

Port-Flow Dialog Data Import

Basic flow data can be entered manually or you can load flowbench data from external sources: Load *Dynomation Airflow* files (.DFW, version 5 and 6), or use the *Import* buttons to load *Flow Pro* files produced on a flowbench equipped with Audie Technology software.

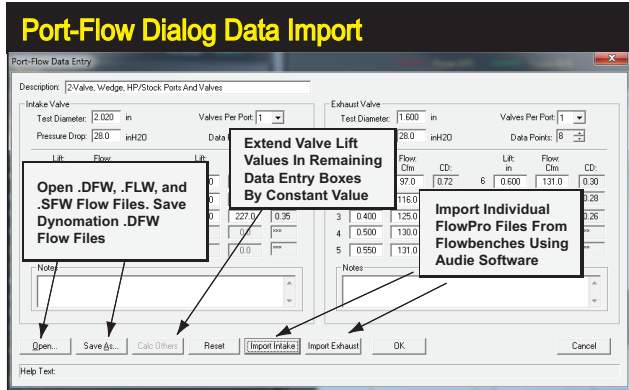

pressure drop. In addition, you can load version 5 and 6 airflow files (.DFW files). You can also *Import FlowPro* files containing individual-port-flow data obtained from flow-bench testing using Audie Technology *FlowPro* software. Open the *Port Flow* dialog by clicking the **Port Flow** button in the *Cylinder Head* component category or clicking the *Port AirFlow* icon in the Toolbar.

To manually enter custom flowbench data, first select a suitable name for the flow data and enter it in the **Description** field. This description will also be displayed in the *Cylinder Head* category **Description** field. Next, select the number of data points in your flowbench test data using the **Data Points** field (a minimum of 4 points are required; click the up icon to increase, down to decrease). Also, enter the **Test Valve Diameters** (valve sizes used on the flow bench), and the **Pressure Drop** (in inches, or mm, of H₂O) used during testing. Enter the number of **Valves Per Port** for individual intake and exhaust ports. Finally, enter **Flow** and **Valve-Lift**

Select Number Of Valves Per Port

Description: 2-Valve, Wedge, HP/Stock Ports And Valves

Inlet Valve

Test Diameter: 2.020 in Valves Per Port: 1

Pressure Drop: 28.0 inH2O Data Points: 1, 2, 3

	Lift in	Flow Cfm	CD:		Lift in	Flow Cfm	CD:
1	0.200	134.0	0.75	6	0.600	223.0	0.40
2	0.300	176.0	0.64	7	0.650	227.0	0.37
3	0.400	213.0	0.58	8	0.700	227.0	0.35
4	0.500	219.0	0.47	9	xxxx	0.0	xxxx
5	0.550	223.0	0.44	10	xxxx	0.0	xxxx

Notes

The simulation will accept flow data from cylinder heads using 1, 2, or 3 valves-per-port. Multiple valves-per-port cylinder heads are flow tested by opening all valves in each port to the same lift while recording the flow rate. The number of valves is used to calculate the overall flow area and the **Coefficient of Discharge**. Since the flow data is always linked to the number of valves, this value can only be selected/changed from within the *Port Flow* dialog.

Cylinder Head Category

Every simulated engine has two intake and two exhaust valve diameters: one pair of **Test Diameters** and one pair of **Running Diameters**. Normally, these valve diameters are the same sizes, but **Dynomation** allows you to enter different **Running Diameters** to test the effects of installing larger (or smaller) intake and/or exhaust valves without changing cylinder-head flow data. Keep in mind that the accuracy of the simulation is best if both **Test** and **Running** diameters are kept the same.

Test vs. Running Valve Diameters

Description: 2-Valve, Wedge, HP/Stock Ports And Valves

Intake Valve

Test Diameter: 2.020 in Valves Per Port: 2

Pressure Drop: 28.0 inH2O Data Points: 4

	Lift: in	Flow: Cfm	CD:		Lift: in	Flow: Cfm
1	0.200	134.0	0.75	6	0.600	223.0
2	0.300	176.0	0.64	7	0.650	227.0
3	0.400	213.0	0.58	8	0.700	227.0
4	0.500	219.0	0.47	9	***	0.0

data for each test point.

Flow Data Entry Tip-1: If you press the **Calc Others** button after entering at least two valve-lift heights, the simulation will fill in the remaining valve-lift fields with the same “step” value that was established in the first two fields.

Flow Data Entry Tip-2: If you have fewer than four test points for one of the valves, duplicate the highest measured flow rate at highest lift value to “flush out” the remaining empty fields. This technique will produce reasonable results, but it is best to have actual flow data that covers the entire valve-lift curve.

Flow Data Entry Tip-3: For cylinder heads with more than one valve per port, the flow values measured on the flowbench should be a measure of the flow for **both** (or **all**) valves in each port opened to the same lift height. *The recorded flow must be the combined flow for all valves in each port.*

You can save flow data in a separate file (.DFW) by pressing the **Save As** button. However, even without doing this, head flow data entered in the **Port Flow Dialog** will be saved with engine data within the current .DXML engine file. It's easy to recall previously saved flow data (a .DFW file), you can also **Open** flow-data files

Auto Calculate Valve Sizes

Valve Specifications:

Intake Valves/Port: 1 Exhaust Valves/Port: 1

Intake Valve Dia: 1.500 in Valve Dia: 1.500 in

Induction

Intake Design: Simple Plenum Model

Runner Connections: Common Plenum

Total Induction Airflow Rate: 650.00

Wave-Action Intake Runner/Plenum

Primary Runner Specifications

Length (Min Area to End): 0.00 in

Min Port Area (per Valve): 0.00 in²

Area At End (Largest Area): 0.00 in²

Average Taper Angle: 0.00 Deg

Bellmouth Not Available On PE

Forced Induction Specification

Compressor: None

Turbine Size: 0.00 in Internal Flow

Turbine A/R: 0.00 Bell Ratio: 0.00

Auto Calculate Valve Sizes

0.80 Inches/ 20.32 mm Diameter

0.90 Inches/ 22.86 mm Diameter

1.00 Inches/ 25.40 mm Diameter

1.10 Inches/ 27.94 mm Diameter

1.20 Inches/ 30.48 mm Diameter

1.30 Inches/ 33.02 mm Diameter

1.40 Inches/ 35.56 mm Diameter

1.50 Inches/ 38.10 mm Diameter

1.60 Inches/ 40.64 mm Diameter

1.80 Inches/ 45.72 mm Diameter

1.94 Inches/ 49.28 mm Diameter

2.02 Inches/ 51.31 mm Diameter

2.08 Inches/ 52.83 mm Diameter

2.19 Inches/ 55.63 mm Diameter

2.30 Inches/ 58.42 mm Diameter

2.40 Inches/ 60.96 mm Diameter

2.50 Inches/ 63.50 mm Diameter

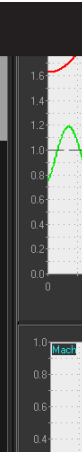

The last selection in the Valve Diameter Menu is **Auto Calculate Valve Sizes** (active only when a “generic” cylinder head has been selected from the **Cylinder Head Description** menu). This feature determines nominal intake and exhaust valve diameters. **Auto Calculate Valve Sizes** will always select valves of an appropriate diameter for the cylinder heads under test and ensure that valve sizes (including in multiple valves-per-port applications) are never too large for the current bore diameter. *Note: This selection is dimmed whenever custom airflow values have been entered in the **Port Flow Dialog**.*

Cylinder Head Category

created in other Motion Software engine simulations, including DynoSim4 and 5 (load .FLW files).

Pressing the **OK** button in the *Port Flow* dialog will transfer flow-test data into the engine simulation and display the flow-test data **Description** in the **CYLINDER HEAD** category.

TEST Valve Diameters

The intake and exhaust **Test Diameters** are entered in the Port-Flow Dialog. These are the diameters of the valves used in the cylinder head during flow-bench testing. Normally, these are the same diameters as the valves used in the simulated engine (the **Running Diameters**), but Dynomation allows you to enter a different Running Diameter to test the effects of installing larger (or even smaller) intake or exhaust valves without retesting the cylinder heads (flow data is “scaled” up or down with the valve diameters). The accuracy of the simulation is best if both **Test** and **Running** diameters are the same, but small differences between these diameters (no more than 5% of the **Test** valve size) will be modeled accurately by the simulation. The results will be as if the larger/smaller valves were installed in the cylinder heads, the heads were retested, and the new flow data was used in Dynomation.

Engine RUNNING Valve Diameters

The **Running Valve Diameter** menus are located in the *Cylinder Head* category. This selection is the diameter of the valves that you wish to use in the simulated engine. As stated previously, the accuracy of the simulation is best if **Test** Diameters (entered in the *Port-Flow* dialog and used during flow-bench testing) are the same

Selecting a specific valve size will disable the **Auto Calculate Valve Size** feature. Select from the provided sizes (displayed in both Metric and US measurements), or you can directly enter any valve dimension within the range limits of the simulation (range limits are shown in the **Status and Range Limit Line**, at the bottom of the main program screen).

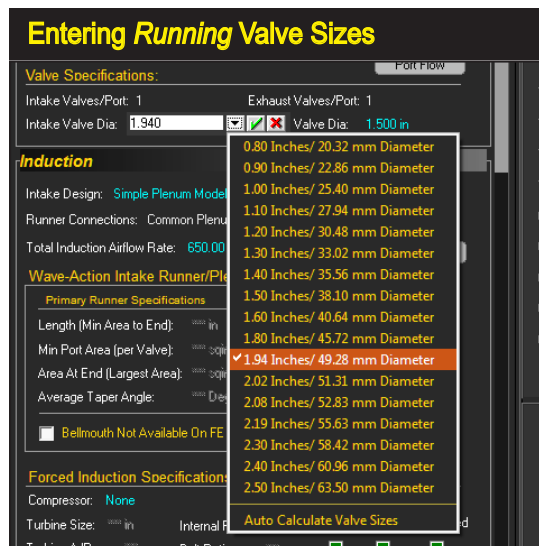

Cylinder Head Category

as the **Running** diameters. However, small differences between these diameters (no more than 5% of the **Test** valve diameter) can be modeled accurately by the simulation. If you use this feature, make sure the CD values (can be displayed on any crank-angle graph) have not exceeded 0.95.

The last selection in each menu is **Auto Calculate Valve Sizes**. This feature is functional only when a “generic” cylinder head was selected from the **Cylinder Head Description** menu. **Auto Calculate** instructs the simulation to determine the nominal intake and exhaust valve diameters for use with the current engine based on an assessment of the bore diameter and cylinder-head selection. When the **Auto Calculate** function is activated, **Auto** will be displayed next to the calculated sizes, and it will remain active on the current engine until turned off (by choosing **Auto Calculate** a second time or by selecting a new diameter for either the intake or exhaust valve).

Auto Calculate will always select valves of an appropriate diameter for the engine under test (including multiple valves-per-port applications) and ensure that valve sizes are never too large for the current bore diameter.

Note-1: Auto Calculation of valve size will only function with the generic cylinderhead choices provided in the **Cylinder Head Type** menu. If any modification is made to these heads, or other Port Flow files are loaded, The simulation assumes that the sizes of the valves are known by the user and **Auto Calculation** is turned off.

Note-2: Auto Calculation is turned **OFF** by default when the simulation is started and whenever **Clear Components** is chosen from the **Edit** menu.

Note-3: While **Auto Calculate Valve Sizes** can be helpful during quick back-to-back testing, it probably will not “guess” the precise valve sizes typically used by the engine/cylinder-head manufacturer.

Wave-Action Only: Selecting Alternate Valve-Flow Area Calculation Methods

The **Port-Flow Dialog** allows you to select alternate methods of calculating port flow areas and, subsequently, valve CDs. To understand how these different algorithms function and when to use them in Dynomation6, a bit of background is helpful.

As we have discussed in this chapter, the method used to determine the restriction in the ports and the mass flow rates within an engine simulation are derived from cylinder-head flowbench test data. Many engine developers have concerns that this steady-state flow may not accurately represent the flow that occurs within the running engine, particularly in high-output, high-speed engines. The cyclical, highly pulsed flow that occurs in the ports as charge moves toward and away from the valves may produce flow regimes across the valve openings that cannot be accurately modeled using steady-state flow measurements.

In addition, the changing shape and geometry of the openings created when the

Cylinder Head Category

Alternate CD Calculation Methods

Port-Flow Data Entry

Description: 2-Valve, Wedge, HP/Pocket Porting, Stock Valve Size

CD Calc Method: Standard Dynamotion Method [DEFAULT]

Intake Valve: Standard Dynamotion Method [DEFAULT]

Exhaust Valve: 2-Step Gordon Blair Method [Boosts Low-Lift CD]

Test Diameter: 2.020 in Valves Per Port: 1

Test Diameter: 2.020 in Valves Per Port: 1

Pressure Drop: 28.0 inH2O Data Points: 8

Pressure Drop: 28.0 inH2O Data Points: 8

Lift: in	Flow: Cfm	CD:	Lift: in	Flow: Cfm	CD:
1 0.200	138.0	0.73	6 0.600	256.0	0.45
2 0.300	187.0	0.65	7 0.650	256.0	0.41
3 0.400	230.0	0.60	8 0.700	256.0	0.38
4 0.500	253.0	0.53	9 ****	0.0	****
5 0.550	256.0	0.49	10 ****	0.0	****

Lift: in	Flow: Cfm	CD:	Lift: in	Flow: Cfm	CD:
1 0.200	107.0	0.71	6 0.600	174.0	0.38
2 0.300	141.0	0.62	7 0.650	181.0	0.37
3 0.400	162.0	0.54	8 0.700	181.0	0.34
4 0.500	174.0	0.46	9 ****	0.0	****
5 0.550	174.0	0.42	10 ****	0.0	****

Notes

Notes

Open... Save As... Calc Others Reset Import Intake Import Exhaust OK Cancel

Select math routines to calculate Coefficients of Discharge and Valve Curtain Areas (See User Manual for more information)

To simulate engines with unique cylinder heads or that have other unique modeling complexities, we have added two new methods of determining Curtain Areas and CD Values. These alternate algorithms may be more appropriate for very high-speed or large displacement racing engines, particularly where pulsed flow may affect engine output. See text for more details.

valves move off their seats may have also affect overall mass flow. And because most engines respond dramatically to changes in low-lift flow, alternate methods of calculating the “exposed areas” of partially-open valves have been developed. The flow areas, also known as the *Curtain Areas*, are the entire open area through which mass can move through each valve at every point in the lift curve. However, analysis has shown that changing flow geometries as the valve moves through low-lift into higher lift regimes can alter the *effective* Curtain Areas. Since the Curtain Area is compared to the calculated flow within in a straight pipe of equal area (to determine the CD or Coefficient of Discharge), using precise Curtain Area values is fundamental in determining accurate flow rates within an engine simulation.

To address these modeling complexities, we have added two additional mathematical algorithms in Dynamotion6 that determine Curtain Areas and CD values using alternate methodologies. An explanation of each of these methods follows. Finally, this section concludes with additional tips and suggestions that can help you model unique powerplants that don't seem to fit the “mold.”

Standard Dynamotion Method (Default): This is the default method used in Dynamotion 4, 5, and 6. It has been successful in modeling with excellent accuracy over a wide range of engines since it's introduction in 1995. We strongly suggest that you, at least, begin any engine design using this method of flow

Cylinder Head Category

area determination. It does not emphasize low-lift flow through the valves, rather it maintains a consistent analysis of valve flow during low- and high-lift regimes (although Dynomation6 includes additional analysis of mass flow within the Wave-Action simulation and can apply a “compression” coefficient to CD values during low-lift flow to improve accuracy).

2-Step Gordon Blair Method: This algorithm was developed by the well-known engine expert Dr. Gordon P. Blair in the mid to late 1990’s. It is based on two separate methods to determine flow areas depending on valve lift (the switch between methods is based primarily on valve dimensions). The overall effect is to decrease calculated flow areas (more on this later) and increase CD values within low-lift values and, to a lesser extent, increase flow throughout the entire lift range. You’ll likely see an increase in power at mid to high rpm, with some loss in torque at lower speeds on high-output engines.

3-Step Treney Simpson Method: This algorithm was developed within a PhD thesis by Dr. Treney Simpson at Iowa State University. It is based on a three-step method to isolate and individually analyze three flow regimes that occur during low- to mid-lift regions of valve lift. The overall effect is very similar to Blair’s method, but with slightly more boost in CD values. This method often produces an increase in high-speed power and slight losses in torque at low engine speeds, although with lesser effect in low-performance engines.

When to Apply Alternate Methods

Since it is virtually impossible to know if alternate CD calculations are helping or hurting the accuracy of the simulation, in most cases these algorithms are best used to help match Dynomation output to actual dyno results. If the engine you are simulating seems to have insufficient top end power, and you have tried modifying other options, like induction airflow, port areas, induction temperatures, etc., the application of one of the alternate CD calculation methods may help you develop a better simulation model.

But there are other options that you might want to consider before you switch to an alternate CD model. For example, by increasing or decreasing the flowbench pressure-drop values entered in the simulation, you can make subtle or dramatic adjustments to the slope of the power curve. You might be thinking that is this somehow “cheating.” In reality, with the uniqueness of each engine design and the way pressure waves and mass flow moves in the engine, if you are able to adjust how static flowbench data is used to better match true dyno output, you are simply extending the concept of refining the simulation model. The more accurately the simulation is able to model your engine, the more useful it will be in predicting the outcome of other engine changes, such as valve timing, exhaust tuning, etc.

Cylinder Head Category

One Final Note: The alternate valve curtain-area algorithms discussed in this section effectively INCREASE the CDs of the intake and exhaust valves over the default Dynomation method. This may seem counter intuitive, since Blair's and Trenergy's methods calculate SMALLER effective valve areas at low- to mid-lift heights. How can smaller flow areas generate higher CDs and more calculated horsepower? The answer lies in the fact that, once again, the measured flow through the valve openings at each lift point is obtained from flowbench testing. And since the two new methods also use this same measured airflow rate (the flowbench values don't change) but through a smaller calculated orifice size, the CD must be higher. Or in other words, the flow through the calculated (smaller) curtain area (again, the same flowbench data) is now closer to the flow in a straight pipe of the smaller cross-sectional area, therefore CD values must increase. (Like many things in engine design, this only makes sense when you think about it a while.)

Induction Category

Induction Category

Induction

Intake Design: **Tunnel-Ram Max-Flow**

Runner Connections: **Common Plenum** Ave. Runner Temp: **180.00 deg**

Total Induction Airflow Rate: **3000.00 Cfm @ 1.50 inHg** **Flow Calc**

Wave-Action Intake Runner/Plenum:

Primary Runner Specifications	Manifold Plenum Volume
Length (Min Area to Entry): 6.000 in	Plenum Volume: 400.0 ci
Min Port Area (per Valve): 3.60 sqin	Calc From Length: 11.052 in
Area At Entry (Largest Area): 9.00 sqin	Calc From Width: 6.016 in
Average Taper Angle: 11.7 Deg	Calc From Depth: 6.016 in

Runners W/Bellmouth Inside Plenum Induction Waves Stability:

Forced Induction Specifications:

Compressor: **None**

Turbine Size: **0.000 in** Internal Ratio: **0.000** Surge Choke Overspeed

Turbine A/R: **0.000** Belt Ratio: **1.00**

Number Turbos: **1**

Boost Limit: **0.000 psi** IC Press. Drop: **None** Intercooler Eff: **None**

The Induction system components are divided into four main groups: 1) *Intake Design*, 2) *The Induction Airflow Rate and Pressure Drop*, 3) *Wave-Action Specific* intake runner specifications, including *Runner Length*, *Entry Area*, and *Minimum Port Area*, *Plenum Volume*, and 4) *Forced Induction* component selections (covered in the next section).

THE INDUCTION CATEGORY

The **Induction** component category establishes the characteristics of the intake flow path from atmosphere to the valve seats. This includes everything upstream of the valves, including the port runners, intake manifold, plenums (if applicable), carburetor or fuel-injection, venturis (if used), any supercharger or turbocharger, and openings to the atmosphere. Induction menus are divided into four main groups: 1) **Intake Design**, 2) **Induction Airflow** and **Pressure Drop**, 3) **Wave-Action specific** intake runner specifications, including **Runner Length**, **Minimum Port Area**, **Area At Entry**, **Plenum Volume**, and **Runner Bellmouth**, finally 4) **Forced Induction** specifications are located at the bottom of the **Induction Category**.

The Intake Design Menu

The **Intake Design** menu consists of 32 intake manifold/system choices plus two “Baseline Models,” a **Baseline Plenum** (Common Plenum) and a **Baseline IR** (Individual Runner) configuration; baseline choices are often used for initial engine development, since simulation results are not modified by specific intake manifold characteristics. All of these selections apply a unique tuning model to the induction system. While these manifolds are only a small sample of the intake manifolds available for IC engines, this list of 34 models simulate most of the manifolds and

Induction Category

The “Baseline” Induction choices remove any specific manifold modeling characteristics from simulation results. Engine developers use these choices (one for Common-Plenum manifolds and one for IR induction) when beginning initial engine development.

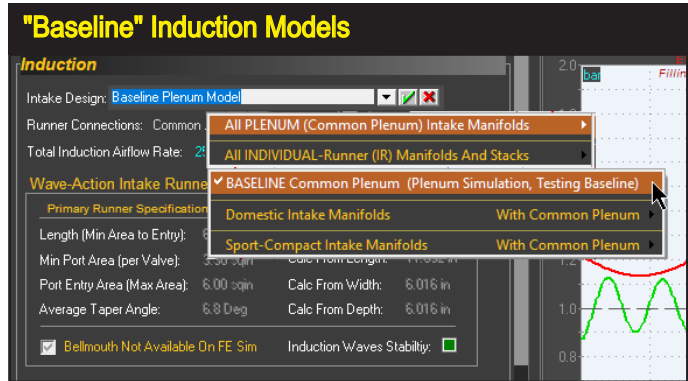

induction systems for both street and racing applications.

The manifold models are divided into four main groups: 1) **“Baseline” Intake Models (2 choices)**, 2) **Plenum—Domestic Intake Manifolds (14 choices)**, 3) **Plenum—Sport-Compact Manifolds(14 choices)**, and 4) **Individual-Runner Inductions(5 choices)**. These categories are only general classifications. In some cases, certain “domestic” engines (utilizing modern tuned-runner induction) are best modeled with selections from the Sport-Compact submenu. Finally, if you are interested in a manifold that falls “in between” two menu selections, you can use the **trend** method to estimate power for a hybrid design. For example, run a test simulation using manifold Type A, then set up a **Quick Comparison™** (right click on the rpm graph) and view the differences in power attributed to manifold Type B. The power differences will give you insight into how a hybrid manifold Type A/B *should* perform.

The Domestic Plenum Manifold menu consists of 13 intake manifold choices. Each of these selections applies a unique tuning model to the induction system. While these manifolds are only a small sample of the intake manifolds available for typical IC engines, these simulation models reproduce the characteristics of many manifolds and induction systems used today for both street and professional/amateur racing applications.

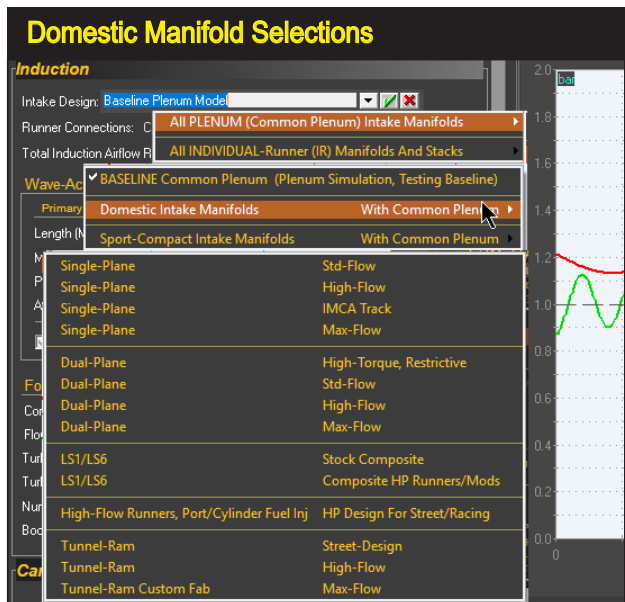

Induction Category

Baseline Manifold Models

The *Baseline Induction* models provided in the **Intake Design** menu apply either no manifold algorithm or use the simplest model available for both the *Filling-And-Emptying* and *Wave-Action* simulations. These baseline models leave simulation results as “untouched” as possible by manifold influences, and this may improve the accuracy of “back-to-back” cam-timing and exhaust-system tuning efforts. In addition, consider using the *Baseline Induction* models if you are unsure of which specific manifold model to apply. The *Baseline Common Plenum* or *Baseline Individual-Runner* choices provide an excellent starting point on which to build further engine testing and development.

Domestic Common-Plenum Manifolds

The following sections provide an overview of each *Domestic Common-Plenum* manifold models provided in the **Intake Design** menu. Here you’ll find a brief description of the assumptions used in each model, and recommendations associated with that individual design.

Domestic—Dual-Plane, (Four versions: Maximum-Torque, Standard-Flow, High-Flow, and Max-Flow Manifolds)

The ***Dual-Plane, Max-Torque Manifold*** models dual-plane manifolds with smaller runners, such as those designed for heavy vehicles, economy and other high-torque, applications. The *Dual-Plane Max-Torque* model will tune for a lower peak engine speed, due mainly to runner and plenum restrictions. The ***Standard-Flow, Dual-Plane Manifold*** selection represents the majority of street-oriented dual-plane manifolds available to performance enthusiasts (including many OEM manifolds). The *Standard-Flow* model will accurately simulate street and performance engines with “as-cast” dual-plane manifolds. The ***Dual-Plane, High-Flow*** and ***Max-Flow Manifold*** selections model modified, large-port, (and even custom-fabricated) dual-plane manifolds, as used on high-performance and all-out racing engines.

Dual-Plane Manifold Theory

Remarkably, the well-known and apparently straightforward design of the dual-plane manifold is, arguably, one of the more functionally-complex manifolds to model. An intake manifold is considered to have an effective dual-plane configuration when 1) the intake runners can be divided into two groups, so that 2) each group alternately receives induction pulses, and 3) the pulses are spaced at even intervals. If all of these criteria are met, the manifold is said to have a 2nd degree

Induction Category

Dual-Plane Manifold

The Edelbrock Performer Q-Jet represents a typical dual-plane manifold design (of “Standard-Flow” capability). This manifold is said to have a 2nd degree of freedom. A powerful resonance multiplies the force of the pressure waves, simulating the effects of long runners, boosting low- and mid-range power.

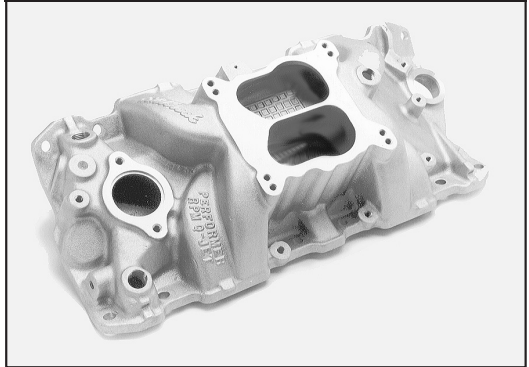

of freedom, allowing it to reach a unique resonance producing oscillations within the entire manifold. During this resonance, pressure readings taken throughout the manifold will be in “sync” with one another. Full-manifold resonance multiplies the force of the pressure waves, simulating the effects of long runners. Since longer runners tune at lower engine speeds, the dual-plane manifold is most known for its ability to boost lower-to-midrange rpm performance.

The divided plenum is another common feature of dual-plane manifolds that boosts low-end power with carbureted engines. Since each side of the plenum is connected to only one-half of the cylinders (4-cylinders in a V8), each cylinder is “exposed” to only one-half of the carburetor. This maximizes wave strength and improves low-speed fuel metering (these effects are less pronounced with throttle-body fuel-injection systems). However, the restriction inherent in a divided plenum can reduce peak power at higher speeds.

The main benefits of the dual-plane design are its low-speed torque-boosting capability, compact design, wide availability, and ease of use with both carburetors and injection systems. However, not all engines are capable of utilizing a dual-plane configuration. Typically, engines that do not have an even firing order or have too

Hybrid Dual-Plane Design



Many dual-plane manifolds are hybrids. This Edelbrock dual-plane manifold is designed for the 440 Chrysler engine and has a partially open plenum. In manifold such as this, the opening adds mid-range and high-speed performance with, typically, a slight sacrifice in low-speed torque. Not all hybrid designs are as successful as this one. In situations where you are not familiar with specific engine or manifold characteristics, it may be worthwhile to stick with “plane-vanilla” designs.

Induction Category

many cylinders to generate a resonance effect will not benefit from a dual-plane manifold. While there are exceptions, engines having 2 or 4 cylinders work best with this manifold. Since most V8 engines are basically two 4-cylinder engines on a common crankshaft, even-firing V8s benefit from the resonance effects of the dual-plane manifold. The simulation does not prevent the selection of a dual-plane manifold on engines that will not develop a full resonance effect. For example, you can install a dual-plane manifold on a 5-cylinder engine, but the results—a low-end power boost—may not be reproducible in the real world, since an effective dual-plane manifold cannot be built for this engine. The *Filling-And-Emptying* simulation is best utilized by modeling dual-plane manifold combinations that already exist rather than testing theoretical fabrications.

Many dual-plane manifolds are hybrids, incorporating facets of other manifold designs. Especially common is the use of an undivided or open plenum typically associated with single-plane manifolds. These “mixed” designs are attempts at harnessing the best features of both manifolds while eliminating the drawbacks of each. Sometimes the combinations are successful, adding more performance without much sacrifice in low-speed driveability. With these designs, you can successfully use the “trend” method described earlier to estimate engine torque and power. Unfortunately, there is no shortage of manifolds that can reduce power without giving anything back in driveability or fuel economy. In fact, some of the worst designs

Dual-Plane vs. Single-Plane Design

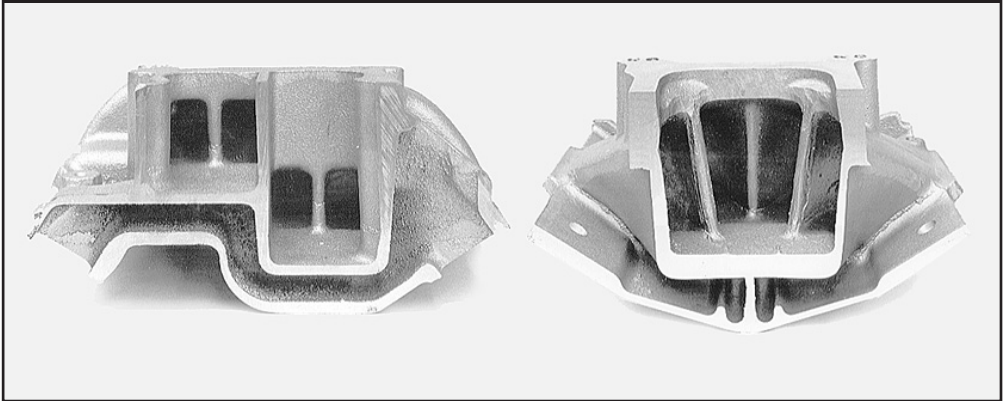

The basic differences between single- and dual-plane manifolds are clearly illustrated here. The dual-plane (left) divides the plenum in half, with the runners grouped by firing order. Each cylinder “sees” only one-half of the carburetor, transferring a strong signal to the venturis. This manifold design is said to have a 2nd degree of freedom, allowing it to reach a unique resonance that makes its short runners act as if they were longer and boosts low-speed power. The single-plane manifold (right) has short, nearly equal-length runners with a large open plenum, much like a tunnel ram laid flat across the top of the engine. The manifold has excellent high-speed performance, but its design prevents full-manifold resonance. That reduces low-speed torque, which can impair driveability and fuel economy.

Induction Category

are remarkably bad. It is impossible to determine which of these combo designs is better than others using Dynamation6 (a future multi-junction version of Dynamation, that models every segment of all intake passages, including the complex effects of multi-cylinder interference, will be able to perform this analysis). Unless you can perform actual dyno testing on these manifolds to determine what works and what doesn't, it may be worthwhile to stick with more "plain-vanilla" designs that produce predictable results.

Domestic—Single-Plane (Three Versions: Standard-Flow, High-Flow, and Max-Flow Manifolds)

The **Single-Plane, Standard-Flow Manifold** selection represents the majority of single-plane manifolds sold to performance enthusiasts. The *Standard-Flow* selection accurately simulates street and performance engines with "as-cast," single-plane manifolds.

The **Single-Plane IMCA Track** manifold is a high flow design with specific modifications to help boost torque in midrange engine speeds. This manifold was designed for IMCA dirt track racing but can be useful for any application needing near-max power with a improved midrange (available from Weiand, as model 7547).

The **Single-Plane High-Flow** and **Max-Flow** manifolds simulate modified, large-port, air-gap, and/or custom-fabricated single-plane manifolds, as used on high-performance and racing engines.

Single-Plane Manifold Theory

In a very real sense, a single-plane manifold is simply a low-profile tunnel ram. The tunnel-ram manifold (discussed next) is a short-runner system combined with a large common plenum; a design that optimizes power on all-out racing engines

A single-plane manifold is simply a low-profile tunnel ram. The design combines short, nearly equal-length runners with an open plenum, but "lays" the entire configuration flat across the top of the engine. The single-plane manifold combines improved flow capacity, higher charge density, and short runners to build substantial horsepower at higher engine speeds.

Single-Plane Manifold

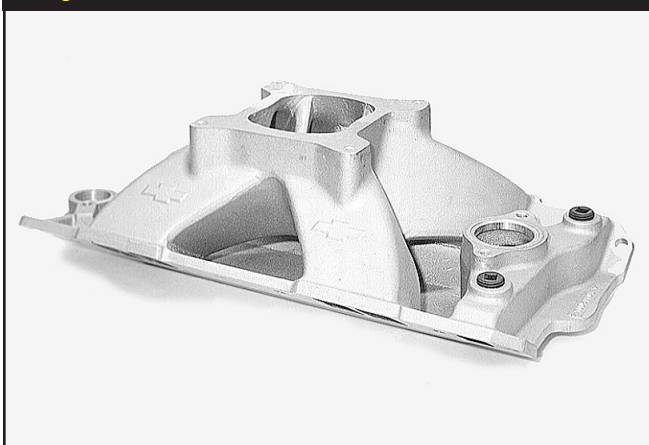

Induction Category

Single-Plane Pulse Interference

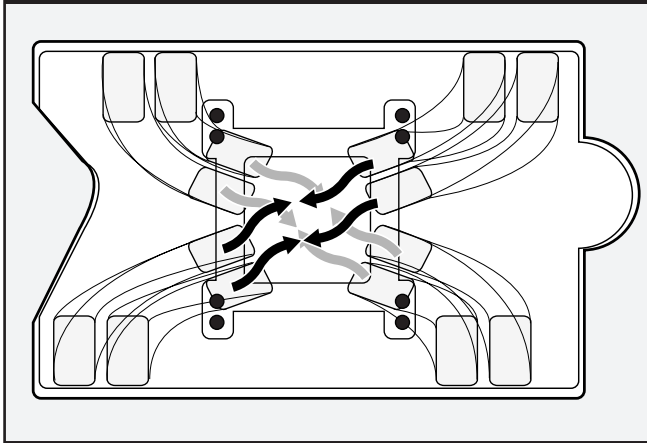

The typically compact, low-profile design of the single-plane manifold has some drawbacks. The runners are connected to a common plenum. This arrangement tends to create unpredictable interference effects as pressure pulses moving through the runners meet in the plenum and stir up a complex brew, sometimes creating irregular fuel-distribution.

where engine-compartment clearance is not an issue. The single-plane manifold combines short, nearly equal-length runners with an open plenum, but “lays” the entire configuration flat across the top of the engine.

The single-plane runner design prevents full-manifold resonance (found in dual-plane manifolds). This reduces low-speed torque, and depending on the size of the plenum and runners, single-plane manifolds can also reduce driveability and fuel economy. Furthermore, large-volume, undivided plenums often contribute to low-speed performance problems by presenting every cylinder to all barrels of the carburetor, lowering venturi signal and low-speed fuel metering accuracy (again, this drawback is minimized on fuel-injection systems). On the other hand, the single-plane manifold (like the tunnel ram) combines improved flow capacity, potentially higher charge density, and short runner lengths to build substantially more horsepower at higher engine speeds.

As a high-performance, high-speed manifold, the single-plane design has many advantages, however, its compact, low-profile design also has drawbacks. The runners are connected to a common plenum like spokes to the hub of a wheel. This arrangement tends to create unpredictable interference effects as pressure pulses moving through the runners meet in the plenum (or travel down the opposite runner) and stir up a complex brew. Large plenum volumes help cancel some these negative effects, but open-plenum, single-plane manifolds may produce unexpected anomalies in fuel distribution and pressure-wave tuning with specific camshafts, headers, or cylinder heads (to some degree, these effects are present in all manifold designs). Locating these will-o'-the-wisp anomalies requires dyno testing and the use of temperature and pressure probes and careful measurement fuel distribution accuracy throughout the rpm range.

Designers and engine testers have experimented with hybrid single-plane manifold designs that incorporate various dual-plane features. One common modification is dividing the plenum of a single-plane manifold into a pseudo dual-plane configura-

Induction Category

tion. While this does increase signal strength at the carburetor, uneven firing pulses presented at each side of the plenum do not allow 2nd degree of freedom resonance. This modification can cause sporadic resonances to occur throughout the rpm range with unpredictable results. Spacers between the carburetor and plenum are also commonly used with single-plane manifolds often with positive results, particularly in racing applications. Spacers typically increase power for two reasons: 1) By increasing plenum volume they tend to reduce unwanted pressure-wave interactions, and 2) a larger plenum improves airflow by reducing the angle at which air/fuel must negotiate a transition from “down” flow through the carburetor to “side” flow into the ports. While there is no way to use trend testing to evaluate the effects of a divided plenum, spacers can be simulated. The increase in plenum volume tends to transform the single-plane manifold into a “mini” tunnel ram, so horsepower gains tend to mimic those obtained by switching to a tunnel ram design (i.e., performance improvements, when found, usually occur at high rpm).

Single-Plane Rule Of Thumb: Since a single-plane manifold typically reduces low-speed torque and improves high-speed horsepower, it is often the best compact manifold design for applications where wide-open-throttle engine speed exceed 4000rpm. If the engine commonly runs through lower speeds, a dual-plane, individual runner, or similar high-torque system will usually provide better performance, driveability, and fuel economy.

Domestic—Tunnel-Ram (Three Versions: Standard, High-Flow, and Max-Flow Designs)

The **Standard Tunnel-Ram Manifold** selection represents a relatively small runner, tunnel-ram manifold with applications in high-performance street (roadster) and mild racing. This selection simulates performance applications with “as-cast,” tunnel-rams with dual- or single-carburetors or throttle bodies.

The **High- And Max-Flow Custom Tunnel-Ram Manifold** models simulate extensively-modified, large-port, and/or custom-fabricated tunnel-ram manifolds, as seen on ProStock and other “exotic” racing engines. The advantages of

Tunnel-Ram Manifold



This Weiand/Holley BB Chevy tunnel ram manifold is a single-plane induction system designed to produce optimum power on all-out racing engines. It has a large common plenum and short, straight, large-volume runners. The tunnel ram manifold menu selections have the potential to produce the highest peak horsepower of all the naturally-aspirated manifolds listed in the *Induction* menu.

Induction Category

This custom-fabricated tunnel-ram manifold (by Jon Kaase Racing Engines) has the potential to produce the highest peak horsepower of all plenum-based, naturally-aspirated induction systems. Combined with the proper cam timing, compression, and other components, the large cross-sectional areas, straight runners, and short tuned lengths make this custom manifold a “no compromise” high-rpm racing design.

Custom Fabricated Tunnel-Ram Manifold

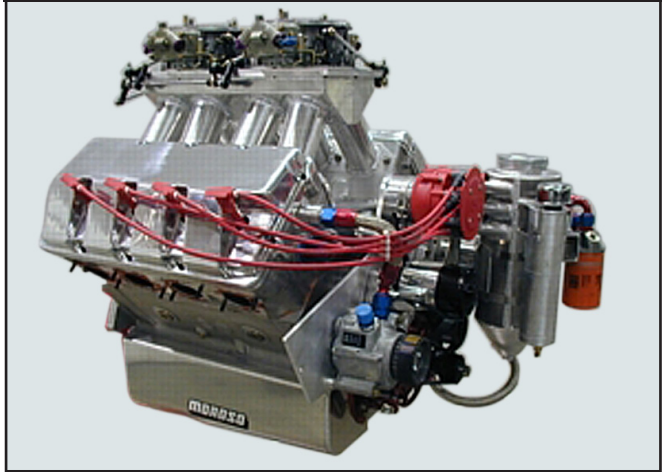

these tunnel rams derive from their combination of a large common plenum and short, straight, large-volume runners. The large plenum can accommodate one or two carburetors, potentially flowing up to 2200cfm or more. The large plenum also minimizes pressure-wave interaction and fuel distribution issues (especially with dual carburetors or fuel-injection throttle bodies). The short runners can be kept cooler than their lay-flat, single- and dual-plane counterparts, and they offer a straight path into the ports, optimizing ram-tuning and minimizing flow restriction.

Tunnel-ram applications are limited because of their large physical size; vehicles using tunnel-ram manifolds usually require a hole in the hood and/or a hood scoop to provide manifold and carburetor clearance. While a protruding induction system may be a “sexy” addition to a street rod, in single-carburetor configurations, the tunnel ram offers very little potential power over a well-designed, single-plane manifold. Only at very high engine speeds, with multiple carburetors, will the advantages in the tunnel ram contribute substantially to power.

The **Standard** and **Max-Flow Tunnel Ram** manifold selections have the potential to produce the highest peak horsepower of all naturally-aspirated induction systems listed in the **Manifold Type** menu. The large cross-sectional areas, straight runners, and short tuned lengths make this manifold a “no compromise” racing design.

Domestic—LS1/LS6 Stock Composite and LS1/LS6 HP Runner/Mods Manifolds

Since the mid 1980’s, engine simulation programs have been regularly used by engine designers and manufacturers to optimize wave dynamics developed inside the intake passages of the IC engine. These pressure waves can have a marked effect on engine performance. When unharnessed, they can pro-

Induction Category

Composite intake manifolds have become standard equipment on many modern IC engines. They allow designs that could not be easily replicated in aluminum, and some offer unique performance technologies. The stock GM LS1/LS6/Z06 induction, shown on the right, and the *FAST* version illustrates the changes in runner length and volumes that can improve power in HP applications.



duce non-uniform fuel distribution, prevent cylinder filling, and adversely affect driveability. On the other hand, when an induction system has been carefully designed to harness pressure-wave dynamics, the engine can benefit from improved airflow and cylinder filling at the desired engine speeds. Using this technology, manifolds can produce “designer” power and torque curves to optimize overall engine performance within specific rpm ranges and within fuel economy and emissions requirements.

The fully composite manifold developed by GM for their “new” smallblock engine is a good example of this design. It is biased toward producing power at higher rpms, while maintaining good torque throughout the rpm range. Installed in many performance vehicles, like the Z06, 405hp Corvette, the new composite design allows high power while maintaining good driveability and low emissions. This manifold can be modeled in the simulation by selecting the **LS1/LS6 Composite Stock** from the Domestic selections provided in the **Manifold Type** menu. Despite the fact that this manifold packs its runners in a small package designed to fit under the low-profile hoods of modern vehicles, generous flow capacities produces good peak power.

Aftermarket companies have taken this concept a bit further to provide

Edelbrock Port Injection Manifold



The final selection in the *Domestic Plenum* manifold menu is a Direct Port Injection manifold with high-flow runners. The Edelbrock Pro-Flo XT is a good example of this design. Because of its tunnel-ram-like features, this manifold offers excellent performance for street and racing applications, yet fits under the hood of most street iron.

Induction Category

more performance for the automotive enthusiast. High-performance versions of this manifold have been shown to add from 3% to 12% more power with very little sacrifice in bottom-end torque. You can test a performance design with the **LS1/LS6 HP Runner/Mod** induction selection. This induction model was based on the **FAST™** manifold for the same engine.

Domestic—Direct Port Injection W/HP Runners & Plenum

This manifold category models modern designs that use direct port injection and incorporate free-flowing runners. This manifold is typically construction like a low-profile tunnel ram, designed for under-the-hood installations. The Edelbrock Pro-Flo XT pictured on the previous page is an example of this type of manifold.

Sport-Compact Common-Plenum Manifolds

The following sections provide an overview of each of the 14 *Sport-Compact* manifold models in the **INDUCTION** category. Here you'll find a brief description of the assumptions used in each model, and recommendations associated with that individual design.

Sport-Compact—Non-Tuned Runner Manifolds (Three Versions: Stock, Ported, Race Ported)

The *Non-Tuned, Small Runner, Stock* selection models an intake manifold with

The *Sport-Compact* manifold submenu consists of 14 choices. Each selection applies a unique tuning model to the induction system. While this is far from a complete list of intake manifolds available for *Sport-Compact* engines, these generic models can simulate many of the manifolds and induction systems available for racing and street applications.



Induction Category

Non-Tuned Manifold

The *Non-Tuned Manifold* selections model intake manifolds with small-diameter runners that connect to a central plenum with little consideration for equal length or tuning characteristics.

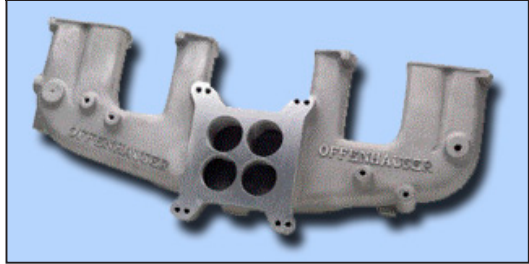

small-diameter runners that connect to a central plenum with little consideration for equal length or tuning characteristics. This restrictive manifold was designed for low-performance economy vehicles or other “basic” engine configurations. In naturally-aspirated applications, this manifold produces the least power and offers the least boost in torque since there is very little runner tuning effects. The *Non-Tuned, Small Runner, Ported Manifold* selection provides a slight improvement in airflow that improves power at higher engine speeds. But the same non-tuned runners provide little pressure-wave tuning and low-speed torque boost.

The *Non-Tuned, Larger Runner, Race Ported* model represents an attempt to improve this simple manifold design as much as possible. By porting the runners, modifying the plenum, and even modifying and welding the runner passages, this is about as much as you can expect to improve this non-tuned intake manifold design. Even with this extensive work, however, this design simply cannot match the torque potential of a stock, OEM, tuned induction system. Primarily, this induction model has been included for comparison purposes, since such basic manifolds are rarely modified to this degree.

Porting the runners, modifying the plenum, and even modifying and welding the runner passages can improve performance on non-tuned manifolds. However, despite extensive modifications to non-tuned manifolds, a more modern OEM-type induction systems will generally produce more torque and horsepower.

Short, Non-Tuned Runners

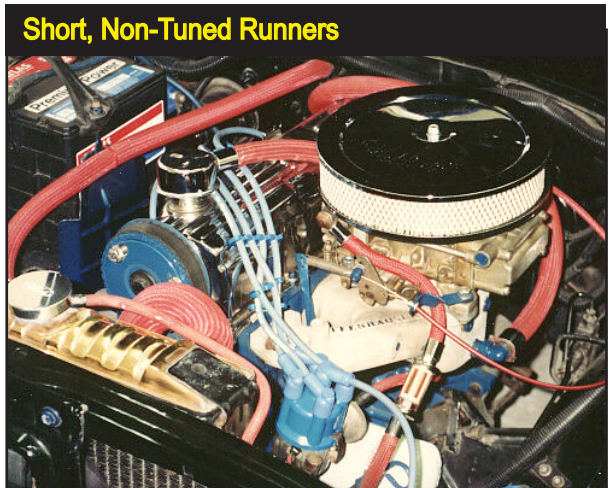

Induction Category

Sport-Compact—Long Tubing Runners, Common-Plenum Manifolds (Three Versions: Basic, HP, & MaxFlow)

The **Long-Tubing Runners, Common-Plenum, Basic OEM Manifold** models the induction system typically used on a flat-four and flat-six engines, like the original VW “Beetle” and lower-performance Porsches. The runner lengths and their relatively small diameters tune for good lower-speed torque, but offer restriction at higher engine speeds. These manifolds are particularly restrictive when used on larger displacement engines (such as those with larger cylinder liners or stroker cranks).

The **Long-Tubing Runners, Common-Plenum, HP Manifold** selection introduces a considerably different *Filling-And-Emptying* induction model. The larger diameter runners offer much less restriction at high engine speeds, but the increased volume dampens low-rpm tuning, often reducing bottom-end torque on all but large-displacement engines. This model closely simulates many naturally-aspirated Porsche 911 induction systems.

Long-Tubing Runners, Common-Plenum, Max-Flow Manifold represents manifold designs used on very high-performance engines or in racing applications. The large runner cross-sectional area ensures cylinder filling at high engine speeds, however, the increased runner and plenum volume further reduces torque at low rpm.

Sport-Compact—Tuned Runner (Four Versions: Restrictive, OEM, High Perf., Max Flow)

All of the manifolds in this **Manifold Type** group model OEM (usually cast aluminum) induction systems. The longest runners produce copious torque at low to medium speeds, while the shortest runner manifolds are commonly used on high-performance, higher-rpm engines.

The **Equal-Length, Cast Long Runner, Max-Torque, Small Plenum** is



Long Tubing Runners With Common Plenum

The **Long-Tubing Basic OEM** manifold selection models induction systems often used on a flat-four and flat-six engines, like the VW and early opposed-six Porsche powerplants. The length of the runners and their relatively small diameters optimize torque, but restrict airflow at higher engine speeds.

Induction Category

Modern "Tubing" Long-Runner Manifold

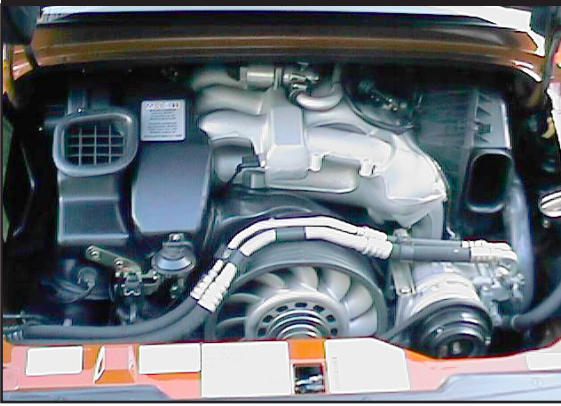

This Porsche 993 uses a cast-aluminum equivalent of the steel-tubing manifolds of the past. While the length of these runners have positioned this induction into the *Tubing, Long-Runner* manifold category, *HP* or *Max-Flow* selections can be used with this free-flowing design.

the first selection in this group, and it models a manifold ideal for engines in heavier vehicles, like trucks and vans. The low-rpm tuning boosts efficiency, economy, and driveability in stock engines. However, while the runners are somewhat long, they are not overly restrictive and stock engines using this manifold will produce good power.

The next selections (downwards in the menu within this 3rd group) is the *OEM, High-Perf.*, and *Max Flow* versions of equal-runner length runner manifolds.

The *Equal-Length, Cast Long Runner, OEM, Small Plenum* version has slightly shorter runners are capable of producing more horsepower, but torque below 3500rpm can suffer somewhat. This is still excellent manifolds for heavier performance vehicles.

The *Equal-Length, Cast Medium Length Runner, HP Design, Medium Size Plenum* manifold is the first manifold in this group to offer a bias toward performance and higher engine speed. Manifolds of this type are commonly

The *Long-Tubing Runners, Common-Plenum, Max-Flow* selection models manifold designs used on high-performance engines or in racing applications, like this Porsche 928 V8. The large runner cross-sectional areas ensure cylinder filling at high engine speeds, however, the additional runner and plenum volume can reduce torque at low rpm, offset somewhat, in this case, by the length of the runners.

"Tubing," Max-Flow Manifold



Induction Category

The *Tuned-Runner Manifold* group (3rd group in Sport Compact menu) models induction systems that have slightly smaller plenums and runners than the more aggressive manifolds in the 4th group of *Flat* or *Horizontal Tunnel Ram* designs. This 3.0L V6 Honda is typical of engines that can be modeled by *Tuned-Runner Manifold* selections. The torque curves are broad and flat, while peak power occurs about 500 to 1000rpm lower than manifolds with shorter runners and larger cross-sectional areas.

Tuned-Runner Induction Systems

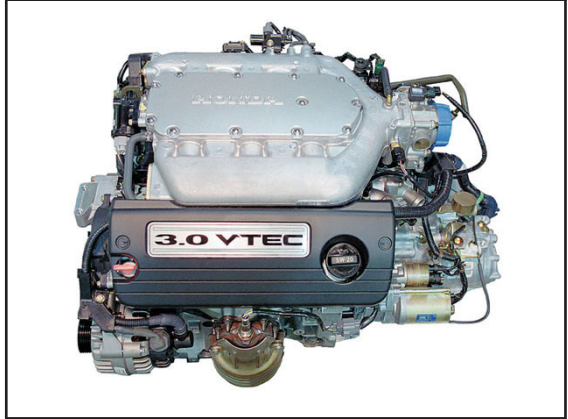

found on 4, V6, V8, and V12 engines in performance sedans and sports cars.

The most performance oriented manifold, the ***Tuned, Short-Runner, Max-Flow, Large Plenum*** is an excellent choice on lightweight, performance vehicles. The tuned runners offer good pressure-wave tuning, while low restriction and large plenum volume give excellent horsepower potential. This manifold design is used on many performance-oriented sports cars, like Aston Martin, Maseratti, and Ferrari. The only manifolds that are superior in performance to this selection are the "***Honda Type***" listed in the next group that have the largest runner and plenum volumes. However, even "Honda" manifolds may not provide as broad a range of torque and power as the manifolds in this group.

Sport-Compact—Honda Type (Four Versions: Standard And Short Runner,

The *Tuned Runner, Medium Length, Larger Plenum* manifold provides a bias toward performance and higher engine speed. Manifolds of this type are commonly found on 4, V6, V8, and V12 engines in performance sedans and sports cars.

Medium-Length, Tuned-Runner Induction

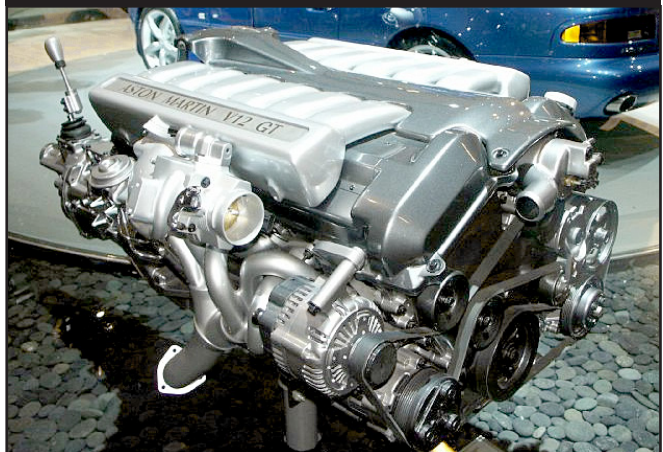

Induction Category

Small And Large Plenum Designs)

While the manifolds in this group are designed to model the Honda induction systems used on their 4-cylinder, high-performance engines, like the B16, B18, S2000 and others. This manifold model can be applied to any engine that uses straight, high-volume runners and a large-volume plenum. The power potential from this manifold model is similar to “all-out” induction systems, such as tunnel-ram manifolds. In fact, we refer to this manifold as a “*Flat Tunnel Ram*,” since it is basically a tunnel ram turned 90-degrees from vertical to horizontal.

The ***Flat Tunnel Ram, Standard-Length Runner, Factory Plenum Volume*** selection models the stock Honda manifold supplied on many of its B16A high-performance engines, like the Del Sol, Civic Si, the Integra GSR, and others. This induction system generates a characteristic broad and flat torque curve (with 4-valve heads), and its large runners and plenum volume will supply all but the largest engines with adequate airflow to well beyond 7500rpm. For many high-performance street vehicles, this is an excellent manifold with the only weak point being somewhat lower torque, usually below 3500- to 4000rpm, compared to the longer-runner manifolds in the previous group. But above these engine speeds, the *OEM Honda-Type* induction system with medium-length runners is virtually unbeatable.

The next “stage” in *Flat-Tunnel Ram* manifold designs is the shorter-runner

Large Plenum, Long And Short Runners (Honda-Type, Flat Tunnel Ram)



The Honda-Type manifold selections (referred to as *Flat Tunnel Rams*) in the simulation model Honda induction systems used on 4-cylinder, high-performance engines, like the B16, B18, S2000 and others. This manifold model can be applied to any engine that uses direct, high-volume runners and a large plenum. The stock-length runner designs (like the Edelbrock Performer X, shown on the left) generate a characteristic broad and flat torque curve, and its large runners and plenum volume will supply all but the largest engines with adequate airflow to well beyond 7500rpm. Manifolds with shorter runners will often lower torque below 4000- 5000-rpm and offer slight-to-significant power gains above 7000- to 8000rpm.

Induction Category

version of the stock B16A intake, the **Flat Tunnel Ram, Short Runner, Factory Plenum Volume**. Manifolds of this type are supplied on the Type R (originally on the 1.8L, B18C5 Honda engines) and are available in many forms from aftermarket manufacturers. They will often generate a slight reduction in torque below 4000- to 5000-rpm and offer a slight-to-significant gain in power above 7000- to 8000rpm. This is not necessarily the best manifold for a small-displacement street engine, but for a modified or “stroker” engine it can offer more power with little or no loss in torque.\

The third selection (working towards the bottom of the menu within this group), is the **Flat Tunnel Ram, Standard-Length Runner, Large Plenum Volume** manifold model. This choice simulates a manifold (only available from the aftermarket, such as the *Edelbrock Performer X* manifold) that has increased cross-sectional area runners of about factory length combined with a large-volume plenum. This manifold will show power gains above max-torque engine speeds, while the standard-length runners will usually maintain good torque at lower speeds. This may be the best manifold for a modified engine that will be operated on the street.

Finally, the **Flat Tunnel Ram, Short Runner, Large Plenum Volume** manifold model simulates many of the exotic induction systems used on racing all-motor and forced induction applications. This induction has the largest volume runners and plenum, and will reduce low-speed torque below about 5000rpm. However expect substantial gains on highly-modified engines, especially above 8000rpm.

Custom Racing Manifolds

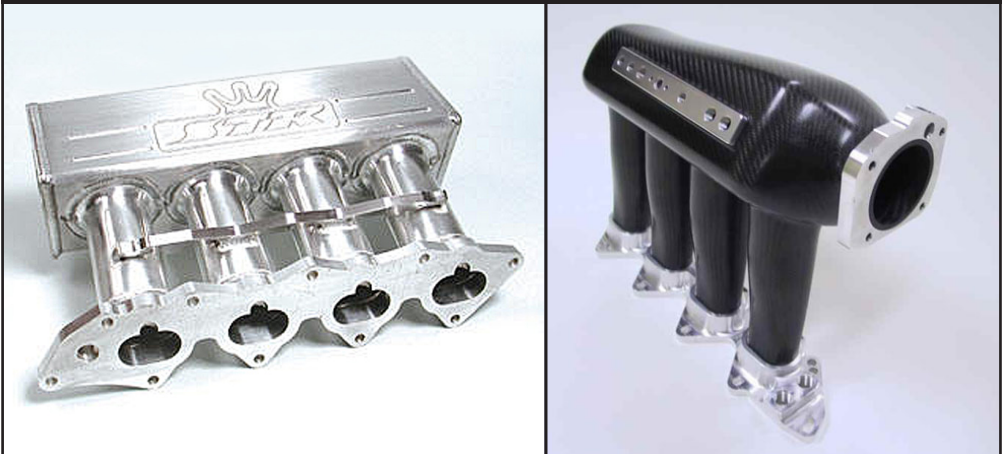

The **Honda-Type, Standard Or Short Runner, Large Volume** manifolds simulate inductions that have increased cross-sectional area runners combined with large plenum volumes. These manifolds will usually reduce low-speed torque below 5000rpm. However expect substantial gains on modified, high-speed engines, especially above 8000rpm. Notice the tapered runners on the manifold on the right.

Induction Category

Individual-Runner Menu Selections

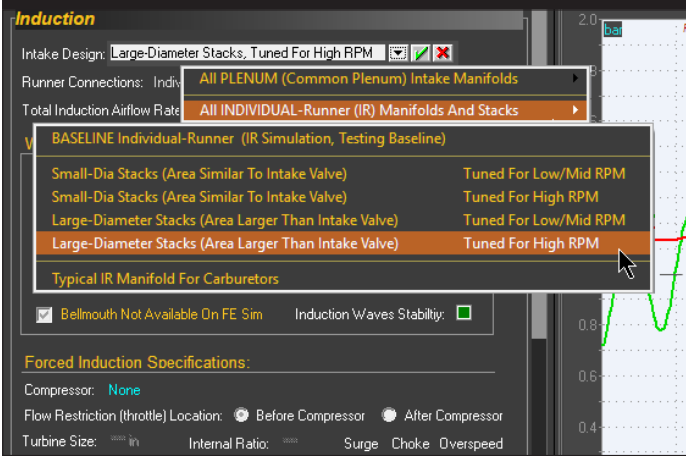

Individual- (or isolated) runner, I.R., induction systems, use separate tubes for each runner with their own individual throttle plates. These induction systems offer the potential for optimum power at high engine speeds.

Individual-Runner Induction Choices

Individual Runner, No Plenum (Large And Small Diameter, Long And Short Stacks)

For naturally-aspirated, professional racing applications, individual- (or isolated) runner (I.R.) induction systems, with separate tubes containing their own throttle plates for each cylinder, can offer the ultimate in power potential at high engine speeds. The single element that sets the I.R. system apart from any other induction models is that each “barrel” or individual “stack” *does not share flow with other stacks through interconnecting passages* (like a plenum). This characteristic means that the overall induction flow is divided between all barrels (or cylinders).

All of the manifolds in the **Manifold Type** submenus that we have discussed up to this point have shared-flow between cylinders, typically through a plenum.

When you select any manifold model from the *Intake Manifold Design* menu, the appropriate plenum model is displayed in the *Plenum Configuration* field. For example, if you select a *Single-Plane* manifold, the *Common Plenum* model is used to analyze total induction airflow. On the other hand, if you select an I.R. system, an *IR Runner* model is used to divide total induction airflow between all cylinders.

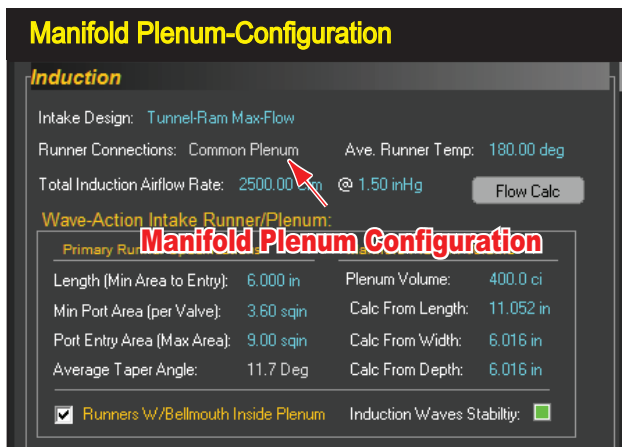

Induction Category

And the induction flow (**Total Induction Flow Rate**) in the **INDUCTION** category specifies the maximum airflow that passes through the restriction common to all cylinders: typically, the throttle body. Similarly, in an I.R. system the **Flow Rate** is the total airflow through all of the individual stacks. So, for example, if each I.R. stack has a rated flow of 100cfm, the correct induction **Flow Rate** you should enter in the Induction Category is 400cfm (100cfm x 4-cylinders).

Note: The **Total Induction Flow Rate** is divided equally between all of the individual runners/stacks.

The **Small Diameter, Longer Stacks** model produces a power curve similar to the *Flat Tunnel Ram, Standard Runner, Factory Volume* manifold discussed in the previous section. However, the improved flow potential over the factory manifold at higher engine speeds offers improved power that will peak at a slightly higher rpm.

The **Small Diameter, Short Stacks** is the shorter-runner version of the previous I.R. selection. It produces a power curve similar to the *Honda Type, Short Runner, Factory Volume* manifold discussed earlier. The improved flow potential at higher engine speeds offers improved power that will peak at a slightly higher rpm. Expect this I.R. induction to produce good power levels beyond 8000rpm on a properly modified race engine.

The **Large Diameter, Long Stacks** selection produces a horsepower curve similar to the *Flat Tunnel Ram, Standard Runner, Large Volume* manifold. The improved flow potential at higher engine speeds offers improved power that will peak at a higher rpm. Expect this I.R. induction to produce good power

Individual Runner (Injector Stack) Induction System

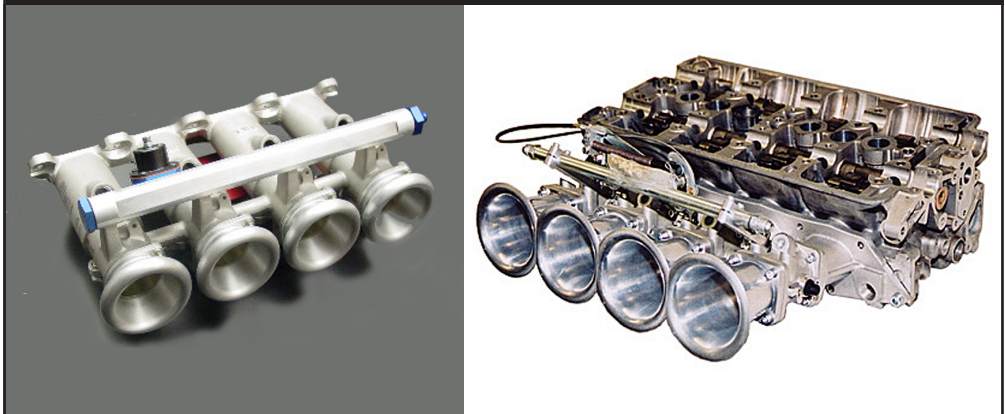

I.R. systems offer the lowest potential restriction of any induction system. The bellmouth entrance can help tune the horsepower peak to the desired rpm range. Careful selection of stack size, length, bellmouth size, and flow rate are essential to building a winning I.R. induction. All of these elements can be tuned and optimized, including elliptical bellmouth runners.

Induction Category

Honda IR Induction

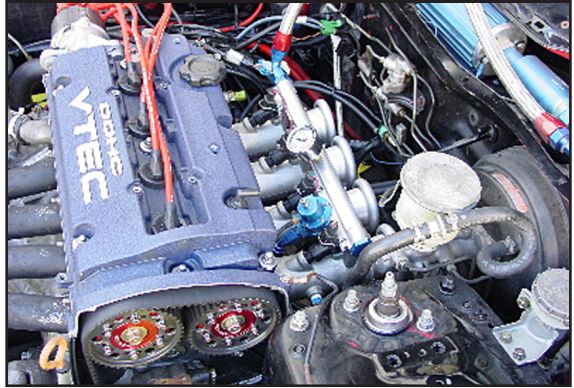

For naturally-aspirated, professional racing applications, individual- (or isolated) runner (I.R.) induction systems offer the ultimate in flow potential and peak power at high engine speeds. Each runner/tube contains its own throttle plate or slide valve.

beyond 8000rpm on a properly modified race engine.

Finally, the **Large Diameter, Short Stacks** produces a horsepower curve similar to the *Flat Tunnel Ram, Short Runner, Large Volume* manifold. The improved flow potential at higher engine speeds offers improved power that will peak at a higher rpm. Expect this I.R. induction to produce excellent power beyond 9000rpm on a properly modified race engine.

Individual Runner Manifold For Carburetors

Similar to the previous I.R. induction systems, individual- (or isolated) runners connect each cylinder to one “barrel” of a (in this case) carburetor and *they do not share flow with other cylinders/barrels through interconnecting passages*. These systems, once commonplace in drag racing, are now mostly limited to specific classes or vintage street vehicles.

While IR systems with carburetors are now rare, they still look awesome. The flow potential of these four Webers is quite a bit less than injector stacks, however in street-rod applications, they produce good low- and mid-range power. The air screens on this setup are available from *Carbs Unlimited* (they offer a range of accessories for Webers and Dellortos carburetors).

Racing/Street IR Carburetion



Induction Category

Runner Wall Temperature

The **Average Runner Temperature** menu sets the temperature of the intake manifold and/or the runner passages leading from the plenum/atmosphere to the junction at the cylinder head. The default selections are 180-degrees(F) for plenum inductions and 120-degrees(F) for individual runner systems.

This temperature setting models manifolds or runners that are cooler (or hotter) than the overall engine temperature (e.g., “air-gap” and other raised-runner designs). Keep in mind that average runner wall temperature only indirectly changes air/fuel charge temperatures. At lower engine speeds, slower runner flow interacts with the walls for a longer time, increasing the exchange of heat. At higher engine speeds, this interaction time decreases, reducing the effects of wall temperature on charge density.

Note: When you select an intake manifold from the **Intake Design** menu, the **Average Runner Temperature** will automatically revert to the default values. Make sure to review (and change, if necessary) runner wall temperatures after selecting an induction system (manifold or IR).

Airflow Selection And Pressure Drop

The **Total Induction Airflow Rate** menus establish the rated airflow for the induction system and the pressure drop at which it’s measured. The consists of **2-barrel-carburetor** and **4-barrel-carburetor/fuel-injection** choices. In addition, you can directly specify any rated airflow from 100 to 7000cfm.

Note-1: The flow ratings for 2-barrel carburetors are measured at a pressure drop twice as high (3.0-in/HG) as the pressure used to rate 4-barrel carburetors and most fuel-injection systems (1.5-in/HG). The higher pressure drop

Average Runner Temperature menu sets the temperature of the intake manifold and/or runners leading from the atmosphere or plenum to the junction at the cylinder head. This temperature lets you model intake systems that are cooler (or hotter) than the overall engine temperature (e.g., “air-gap” manifold designs).

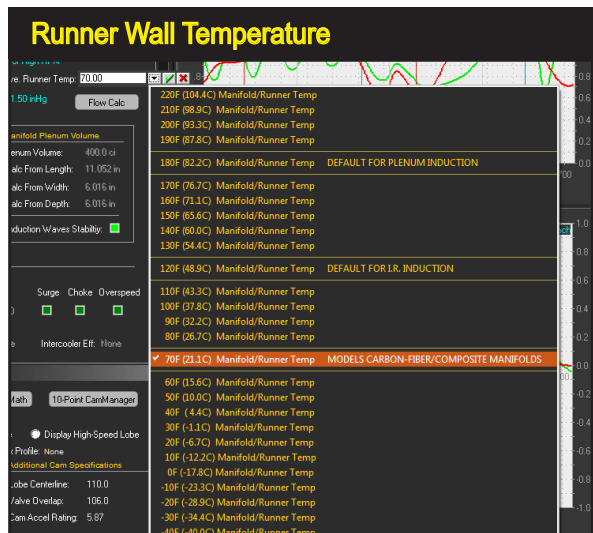

Induction Category

increases the measurement resolution for smaller carburetors and “shifts” the flow numbers toward the range commonly found in automotive applications (roughly, 100 to 700cfm). The pressure drop is the pressure differential maintained across the system (e.g., carburetor or throttle body) during airflow measurement at wide-open throttle.

Note-2: You can use the built-in **Airflow Pressure-Drop Conversion Calculator** (available in the *Tools Menu*) for quick conversions between airflow and pressure-drop values.

Airflow Rate Assumptions

The **Total Induction AirFlow** menu selections “install” **2-bbl** carburetors from 300- to 600cfm or **4/8-Bbl Carb Or Inj.** systems from 300- to 7000cfm. The **4/8-BBL** label indicates that the induction system can consist of single or multiple carburetors (or fuel injection throttles.) that combine to produce of the rated airflow. An induction system equipped with twin 1100cfm carburetors would have a rated airflow of 2200cfm. If an air cleaner is used, total airflow (at the same pressure drop) should be adjusted to compensate for the increase in restriction at the atmospheric boundary.

Note: The simulation makes *no assumption about the type of restriction* used in the induction system (any throttle configuration, any runner shapes or inter-connections, etc.). The airflow rating is simply a means to model the greatest overall restriction of the entire induction system. As higher airflow levels are

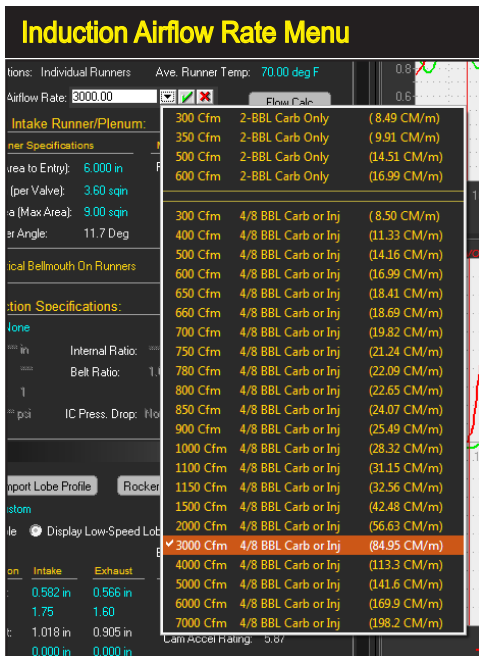

The **Total Induction Airflow Rate** menu establishes the flow rate and pressure drop through the induction system. It also establishes an overall airflow restriction for induction modeling. The menu consists of 2-barrel-carburetors (at 3.0-in/Hg) and 4-barrel-carburetor/fuel-injection choices (at 1.5-in/Hg). In addition, you can directly enter any airflow from 100 to 7000cfm at either pressure drop.

Induction Category

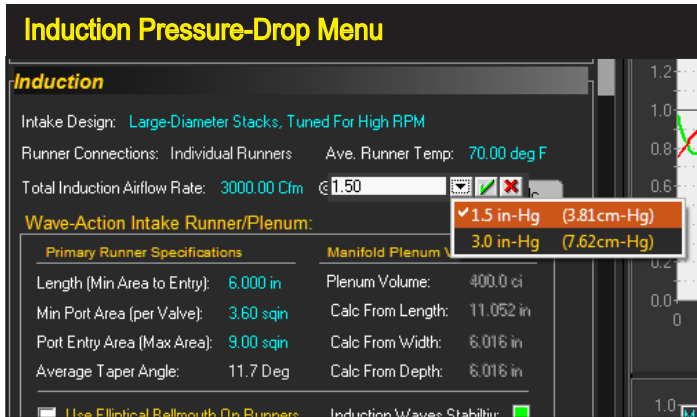

Use the *Induction Airflow Pressure Drop* menu to select either 1.5-inches of mercury (1.5-in/Hg), a measurement standard for 4-barrel carburetors and injection systems, and the two-barrel carburetor standard of 3.0-inches of mercury (3.0-in/Hg).

selected, the simulation lowers the restriction within the induction system.

Wave-Action Only Intake-Runner Specifications

The power of the *Wave-Action* simulation lies in its ability to predict and analyze the interaction of pressure waves and their influence on mass flow in the engine. By design, this simulation is sensitive to runner lengths, passage taper angles and volumes. The *Induction* category includes a group of data-input fields specifically for the *Wave-Action* simulation. These fields are **Runner Length**, **Port Entry Area**, **Minimum Port Area**, and **Plenum Volume**, plus a checkbox to activate an **Elliptical Bellmouth** model applied to the runner atmospheric boundary.

The following sections provide an overview of each of these *Wave-Action* intake-runner data-entry fields:

Runner Length (WA Only)

This is the distance from the point of minimum cross-sectional area to the location in the port where the area substantially increases. In a common-plenum manifold, like a single-plane or tunnel-ram, this point is usually located at the plenum junction. In the case of an individual-runner system, this transition occurs at the bellmouth of the velocity stack.

Port Entry Area (WA Only)

This is the area at the entrance to the port runner (in in² or mm², depending on the **Units** currently selected). This value is the starting point for the port, and is used, along with the *Minimum Port Area*, to determine the included *Port Taper Angle*, a critical dimension analyzed in the *Wave-Action* simulation.

Minimum Port Area (WA Only)

Induction Category

This is the area at the point of *greatest restriction* in the port and is also the point at which runner length is measured. It is usually located just above the valve seat near the valve guide, however, it may also occur at other locations within the port. The *Minimum Port Area* is a very critical engine dimension; carefully measure and/or calculate this value to optimize simulation accuracy in Dynomation6. If you inaccurately measure this value, horsepower predictions and your tuning efforts will also be inaccurate.

As you test various engine configurations using the Wave-Action model, you will find that *Minimum Port Area* has a "resonant" value at the point of optimum power. For any particular engine, areas larger or smaller than this will produce less power. If your cylinder heads provide optimum port areas and *Taper Angles*, your engine can produce peak power.

When the *Minimum Port Area* is tuned to an optimum size, it generates a "sweet spot" between restriction that produces high port velocities, allowing pressure waves to impart sufficient energy to the intake charge and "ram tune" the cylinders, versus an oversize area that, although offering less restriction, depletes the strength of pressure-waves and consequently diminishes cylinder filling. Rapidly pinpointing the *Minimum Port Area* that produces peak performance is a terrific strength of the wave-action simulation.

Determining optimum *Minimum Port Area* is entirely dependent on engine displacement, cam timing, port flow, valve sizes, engine speed range, and many other variables that make this job extremely difficult without using a mathematical simulation. Dynomation6 analyzes all of these variables in every Wave-Action run. After just a few simulations, you can easily home-in on an optimum *Minimum Port Area* for any engine application!

Important-1: This may seem obvious (but it's easy to forget), the *Port Entry Area* and *Minimum Port Area* are **areas**, not diameters of the ports/runners.

Important-2: The *Minimum Port Area* can range from below 50% of the area of the intake valve, to as large a 75-to-80% or larger of the valve area in racing cylinder heads.

Wave-Action-Only Induction Fields

Wave-Action Intake Runner/Plenum:

Primary Runner Specifications

Length (Min Area to Entry): 6.000 in

Min Port Area (per Valve): 3.60 sqin

Port Entry Area (Max Area): 9.00 sqin

Average Taper Angle: 11.7 Deg

Manifold Plenum Volume

Plenum Volume: 400.0 ci

Calc From Length: 11.052 in

Calc From Width: 6.016 in

Calc From Depth: 6.016 in

Runners W/Bellmouth Inside Plenum

Induction Waves Stability:

The *Induction* category includes data-input fields specifically for the *Wave-Action* simulation. These are *Runner Length*, *Port Entry Area*, *Minimum Port Area*, and *Plenum Volume*, plus a checkbox to activate an Elliptical Bellmouth model.

Induction Category

Measuring Runner Dimensions

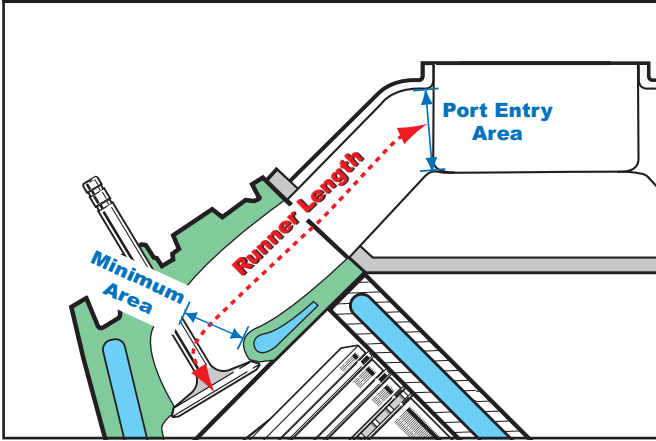

Intake *Runner Length* in the wave-action simulation is defined as the distance from the point of minimum area to the point where the port area substantially increases. *Port Entry Area* is measured at the port entrance junction with the plenum or just inside the runner bellmouth. And the *Minimum Port Area* usually occurs just above the valve seat, although it can occur at other locations in the port.

Important-3: The *Minimum Port Area* is a dimension in in^2 or mm^2 (depending on the current **Units** selection) within the port of **Each Valve** of multiple-valve-per-port cylinder heads. **Do Not Add** minimum port areas together when you enter a *Minimum Port Area* for 2- or 3-valves-per-port applications.

Plenum Volume (WA Only)

The **Plenum Volume** models the *volume* (in^3 or mm^3) not the *shape*, of a plenum used in *Common-Plenum* induction systems. You can directly enter the volume of the plenum, or enter the approximate physical dimensions and Dynamation6 will calculate the volume. The minimum plenum volume is dependent on the *Port Entry Area* (Maximum Area of the port). The simulation checks to ensure a transition of sufficiently large volume occurs at the port/plenum boundary. If a larger plenum

Intake Port Taper Angle

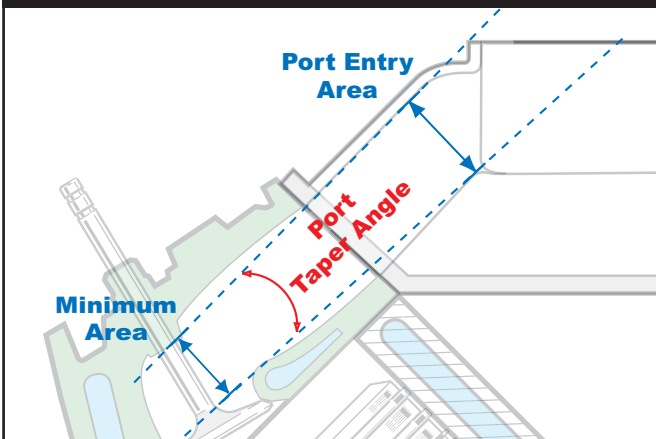

Intake runner *Minimum Port Area* and *Taper Angle* are critical dimensions in the induction system. If incorrect values are entered, power predictions will also be incorrect.

NOTE: The *Minimum Port Area* value used in Dynamation6 is the area *Per Port*. If you are modeling multiple-valve-per-port cylinder heads (2 or 3 valves per port), do not add these port areas together to determine *Minimum Port Area*!

Induction Category

volume is required, a message box will indicate the issue and it will be corrected automatically when you click on **OK**.

Note: Only the volume of the plenum is used in the simulation; height, width and depth are only used to calculate a volume and hold no further significance within the simulation.

Elliptical Bellmouth (WA Only)

A checkbox is provided in the *Induction* category to activate an **Elliptical Bellmouth** model that can be applied to the runners, either at their connection to a plenum or at the atmospheric interface. Principal bellmouth characteristics include a wide radius with an elliptical profile and a short overall height (equal to the diameter of the main stack tube). The effects on performance generally occur at higher rpm but depend on runner dimensions and overall engine design.

An Elliptical Bellmouth may be added to the end of intake runners using the Wave-Action simulation. Here are the typical dimensional relationships modeled by the sim. An Elliptical profile typically outperforms a simple radius or airfoil shapes.

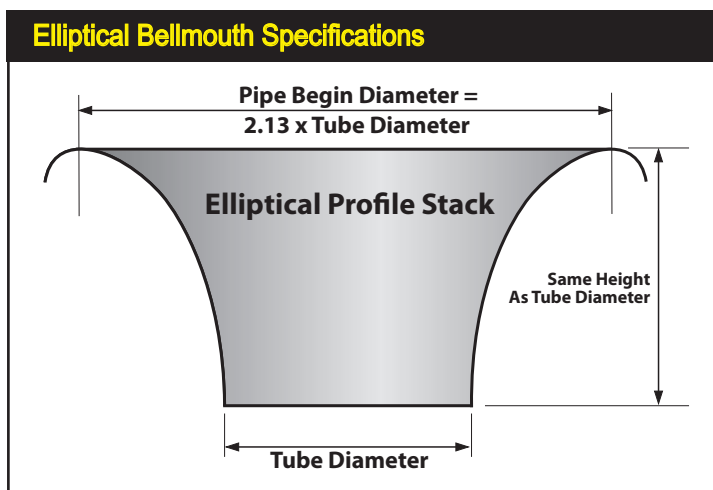

Induction Category (Forced Induction)

Induction Category Forced Induction Choices

Induction

Intake Design: **Simple Plenum Model**

Runner Connections: **Common Plenum** Ave. Runner Temp: **180.00 deg**

Total Induction Airflow Rate: **1200.00 Cfm** @ **1.50 inHg** **Flow Calc**

Wave-Action Intake Runner/Plenum:

Primary Runner Specifications		Manifold Plenum Volume	
Length (Min Area to Entry):	3.500 in	Plenum Volume:	100.0 ci
Min Port Area (per Valve):	1.00 sqin	Calc From Length:	6.962 in
Port Entry Area (Max Area):	2.00 sqin	Calc From Width:	3.790 in
Average Taper Angle:	2.8 Deg	Calc From Depth:	3.790 in

Bellmouth Not Available On FE Sim Induction Waves Stability:

Forced Induction Specifications:

Compressor: **Turbo-Garrett-GTX3076R-76-58**

Turbine Size:	2.800 in	Internal Ratio:	1.00	Surge	Choke	Overspeed
Turbine A/R:	0.70	Belt Ratio:	1.00	<input checked="" type="checkbox"/>	<input type="checkbox"/>	<input checked="" type="checkbox"/>
Number Turbos:	1					
Boost Limit:	20.0 psi	IC Press. Drop:	0.5 psi	Intercooler Eff:	100.0 %	

The **Induction Category** includes several **Forced-Induction** systems, including **Roots & Screw Blowers**, **Centrifugal Blowers**, and **Turbochargers** (any of which can be used with **Nitrous Injection**, discussed later in this manual). Fields that are not applicable to the current forced-induction method are dimmed, like the **Internal** and **Belt Ratios** when a turbocharger is used.

Forced-Induction Specifications Applies To Both the FE and WA Simulations

The **Forced Induction Selections** included in the **Induction** category considerably expand the modeling power of **Dynomation6** and **DynoSim6**. You can add a positive displacement **Roots-** or **Screw-type** blowers, a centrifugal blower (like a **Rotrex** or **Vortech**), or a turbocharger to any engine. In addition, you can vary maximum boost—or blow-off (wastegate) pressure—**Belt Ratios**, **Turbine Size**, **Turbine A/R** ratio, **Intercooler** parameters, and more.

Note-1: When you apply any of the forced-induction systems, keep in mind that you are adding forced induction to the intake manifold selected in the **Intake Design** menu.

Note-2: Adding forced induction to **Individual-Runner** selections, while technically possible, converts the IR system into a common plenum configuration by the plumbing interconnections required to route airflow to each stack.

To select any of the forced-induction options, double-click the **Compressor** field to open a menu containing **Turbocharger**, **Centrifugal**, **Roots**, and **Screw** blower choices. After a selection has been made, appropriate fields in the **Forced Induction** group will become active depending on the characteristics of the selected supercharger. You may modify these values at any time to determine their effect on engine power.

Here is a quick overview of the supercharger component fields, the supercharg-

Induction Category (Forced Induction)

Forced Induction Menus

The screenshot displays the Dynomation6 software interface. On the left, a list of turbochargers is shown with their respective specifications. The central panel contains various simulation parameters such as 'Hybrid-Sim Model', 'Start RPM: 1000', 'Finish RPM: 14000', and 'Air Temp: 68.00 deg F'. The right panel features a graph titled 'Filling/Emptying Mode' with a y-axis ranging from 0 to 1000 and an x-axis from -1000 to 3000. The graph shows a red line that starts at approximately 100 at x=-1000 and rises to about 800 at x=3000.

Garrett	0.1L - 0.5L	20 - 80HP
Garrett GT1241 41.50	0.4L - 1.2L	50 - 150HP
Garrett GT1544 43.9 56	1.0L - 1.6L	100 - 200HP
Garrett GT1548 43 60	1.0L - 1.6L	100 - 200HP
Garrett GT2032 52.2 48	1.4L - 2.0L	140 - 210HP
Garrett GT2032 52 50	1.4L - 2.0L	140 - 210HP
Garrett GT2032 52 52	1.4L - 2.0L	140 - 230HP
Garrett GT2036 56 55	1.4L - 2.0L	140 - 260HP
Garrett GT2239 59 60	1.7L - 2.5L	150 - 260HP
Garrett GT2239 59 62	1.7L - 2.5L	160 - 280HP
Garrett GT2534R 54.3 80	1.4L - 2.2L	170 - 270HP
Garrett GT2560R 60.1 60	1.6L - 2.5L	200 - 330HP
Garrett GT2548R 54.3 80	1.4L - 2.2L	170 - 270HP
Garrett GT2899R 59.4 56	1.8L - 3.0L	150 - 310HP
Garrett GT2860R 60.1 55	1.8L - 3.0L	150 - 310HP
Garrett GT2860R 60.1 62	1.8L - 3.0L, Nissan RB26DETT	250 - 360HP
Garrett GT2860R 60.1 62	1.8L - 3.0L, Disco Potato	250 - 360HP
Garrett GT2860R 60.1 62	1.8L - 3.0L	250 - 360HP
Garrett GT2860R 60.1 49	1.2L - 2.5L, Rally Potato	200 - 300HP
Garrett GT2860R 60.1 49	1.2L - 2.5L, W/34mm Restrictor	200 - 300HP
Garrett GT2860R 60.0 58	1.6L - 2.5L	200 - 400HP

The simulation includes over 100 forced induction choices. Selecting a supercharger from any of the submenus will load that device into the *Induction Category* and transfer supercharger-map data into the simulation.

ers to which they apply, and how they affect forced-induction performance:

Flow Restriction (throttle) Location—The location of the primary intake restriction (commonly the throttle) can have a significant affect on forced induction engines. If the restriction is located **Before** the compressor, inducted air is *drawn-through* the restriction and (like all naturally aspirated engines) the maximum pressure drop (and resulting mass flow) through the restriction is limited to one atmosphere. However, if the restriction is positioned **After** the compressor, the pressure drop across the same restriction is limited by manifold pressure (as opposed to atmospheric pressure), potentially generating greater mass flow for the same size restriction. Many turbo systems position the throttle after the compressor, while Roots and Centrifugal compressors typically place the throttles before the compressor.

Turbine Size—(Turbos only) This is the diameter of the exhaust-driven impeller (in inches or millimeters). The turbine is placed in the exhaust stream of an engine

Turbine & Compressor Impellers

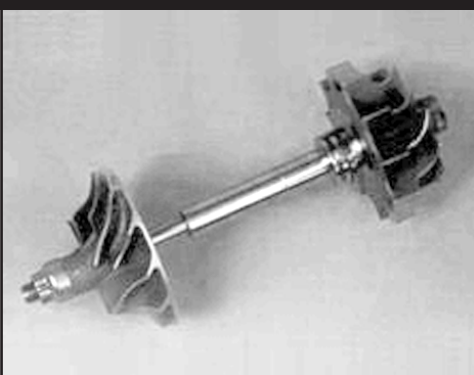

The turbine (impeller shown on the right end of the shaft) is placed in the exhaust stream of an engine and is driven by a combination of exhaust flow and exhaust pressure waves. Two parameters in the simulation adjust the performance of the turbine: the *Turbine Wheel Size* and the *Turbine Housing A/R Ratio*. Modifying the turbine wheel size will make large changes in the turbine speed; the smaller the wheel, the faster the turbine will rotate. The higher the turbine speed, the more airflow will be driven through the compressor (until the compressor blade tips reach supersonic speed).

Induction Category (Forced Induction)

A/R Turbine-Housing Ratio

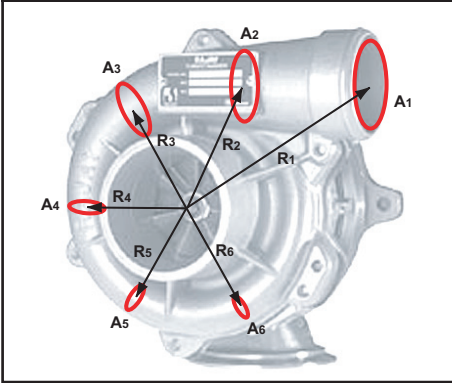

The *Turbine* (the exhaust-driven element) *Housing A/R* ratio is a comparison of the cross-sectional area of the housing inlet (the “A’s” in the photo) to the distance the inlet passage is positioned from the center of the turbine (the radius, or “R’s” in the photo). Unlike the *Turbine Size* (that has a dramatic affect on turbine speed), the *Turbine Housing A/R Ratio* fine-tunes turbine speed and helps establish where—in the engine rpm range—the turbo begins to produce boost pressure.

and is driven by a combination of exhaust flow and exhaust pressure pulses. Two parameters adjust the performance of the turbine: in general, the *Turbine Wheel Size* and the *Turbine Housing A/R Ratio* (discussed next). Modifying the turbine wheel size will make relatively large changes in the turbine speed; the smaller the wheel, the faster the turbine (and the compressor) will rotate. The higher the turbine speed, the more airflow will be driven through the compressor. Smaller turbines generate boost earlier in the rpm range, however, if the turbine is too small for the application, the turbocharger shaft speed can exceed the manufacturer’s recommendations (turning the *Overspeed* indicator from green to yellow, and if overspeed is sufficiently high, it will turn red).

Turbine Housing A/R Ratio—(Turbo only) This is a ratio of the cross-sectional area of the turbine housing inlet to the inlet passage distance (radius) from

Boost Limiter (Wastegate)

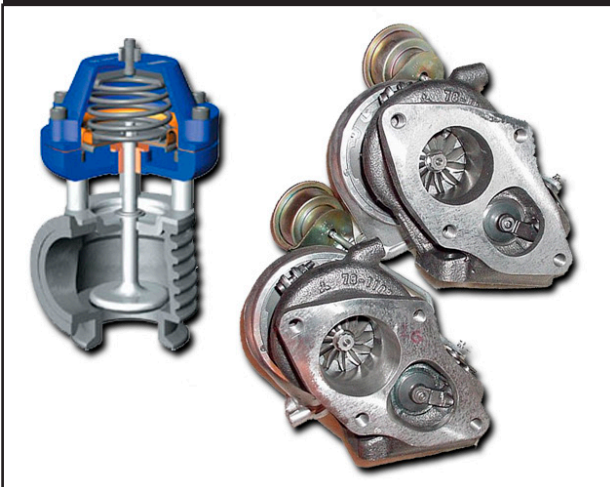

Boost Limit is an arbitrary maximum induction pressure established by the wastegate setting. It is not a measure of the capability of the super-charger, i.e., the blower may or may not be able to develop sufficient pressure to activate the wastegate. The simulation incorporates a wastegate model that modulates the size of its bypass passages when the *Boost Limit* is reached.

Induction Category (Forced Induction)

Belt Ratio



Both centrifugal and roots blowers are mechanically driven by the engine. The **Belt Gear Ratio** (external drive) is the mechanical connection between the engine crankshaft and blower input shaft. This Jackson Supercharger pulley setup provides an overdrive (an overall **Belt Ratio** of 1.20:1).

the center of the turbine wheel (see photo). As the **A/R Ratio** is increased, the overall size of the turbine housing and its internal passage become larger. Unlike **Turbine Size** that has a dramatic affect on turbine speed, the **Turbine A/R Ratio** fine-tunes turbine speed. Changing **A/R** has many effects. By using a larger **A/R Ratio**, the turbo produces less boost at lower engine speeds but develops more boost at a higher engine speeds, primarily due to the reduction in exhaust backpressure in larger turbine housings. Lower engine backpressure improves engine volumetric efficiency (VE), and that can result in an power increase throughout the usable rpm range. So, finding the optimum values for both the **A/R Ratio** and **Turbine Size** are important steps in building the most efficient and responsive turbocharger system.

Number Of Turbos—(Turbos only) This selection divides the exhaust flow and in-

Centrifugal superchargers are driven through an external **Belt Ratio**, but this speed increase is insufficient for most centrifugal superchargers to reach their optimum operating speeds (35,000rpm and higher). An internal gear train is commonly used to further increase rotational speed.

Internal Gear Ratio

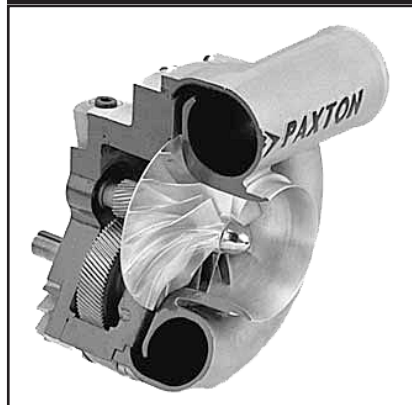

Induction Category (Forced Induction)

take flow restrictions equally between all turbos (up to four turbos in parallel can be modeled). Compressed outflow from all turbos is directed into the induction system of the engine (through an intercooler, if selected) and is divided equally between all cylinders. Multiple turbo applications are most successful when the engine produces sufficient exhaust-gas volume to spin up all turbos; using small turbine sizes and housings usually improves multiple-turbo applications.

Boost Limit—(Turbos, Centrifugals, Roots, Screw) This is the pressure at which the wastegate or blow-off valve is activated, maintaining maximum induction pressure at or below this value.

Note: Boost Limit is an arbitrary pressure, chosen by you, for the simulation. It is not a measure of the capability of the supercharger. In other words, because of component mismatch and other factors, the blower may not be able to develop sufficient airflow and boost to reach the wastegate relief pressure.

Belt Ratio—(Centrifugals, Roots, Screw) Centrifugal, roots, and screw superchargers are mechanically driven by the engine. The **Belt Ratio** (the external drive ratio) is the ratio of the mechanical connection between the engine crankshaft and blower input shaft. This value is multiplied by the **Internal Ratio** (internal gear ratios are commonly used on centrifugal superchargers) to determine final compressor/rotor speed.

Internal Ratio—(Centrifugal) Centrifugal superchargers are driven by a mechanical connection to the engine crankshaft (the external **Belt Ratio**). Input shaft speed, however, it usually insufficient for most centrifugal superchargers to reach their optimum operating speeds (35,000rpm and higher), so an internal gear train is commonly used to further increase rotational speed. The ratio of this internal gearing determines how much faster the turbine rotates. To determine the final speed of a centrifugal turbine, multiply crankshaft rpm by the **Belt Ratio**, then multiply that by the **Internal Ratio**.

Operational Indicators—(Turbos, Centrifugals) The forced-induction portion of the

Operational Indicators

Average Taper Angle:	2.8 Deg	Calc From Depth:	3.790 in
<input type="checkbox"/> Bellmouth Not Available On FE Sim		Induction Waves Stability:	<input checked="" type="checkbox"/>

Forced Induction Specifications:

Compressor:	Turbo-Garrett-GTX3076R-76-58				
Turbine Size:	2.800 in	Internal Ratio:	1.00		
Turbine A/R:	0.70	Belt Ratio:	1.00		
Number Turbos:	1	Surge	Choke	Overspeed	
Boost Limit:	20.0 psi	IC Press. Drop:	0.5 psi	Intercooler Eff:	100.0 %

The Forced Induction Specifications group includes three “indicators” that will alert you if **Surge**, **Choke**, or **Overspeed** are present during any portion of the test rpm range. See the text for a definition of each indicator and tips on how to correct problems. Also, refer to the **Simulation Log** for more information about the indicated problem.

Induction Category (Forced Induction)

Induction category includes three “indicators” that will help you select the correct turbocharger, turbine wheel size, and A/R ratio. Each indicator shows a potential operational problem by turning from green to yellow (minimal problem), or to red (should be corrected). Additional information about the cause and extent of the problem will be included in the Simulation Log (displayed using the *Simulation Menu*).

Surge: (Turbo Only) This condition occurs when mismatched components cause unstable airflow through the compressor. If a turbo is operated consistently within surge, additional loads can damage the turbines, shafts, and bearings. If surge is detected during a simulation run, the **Surge** indicator will display either yellow or red. A yellow **Surge** indicator means that the turbo has entered surge only a limited time during the full engine rpm range. This limited-surge operation is not considered unusual and is not normally associated with shortened turbocharger life. If the indicator turns red, the turbo has entered into surge often during the engine “dyno test.” The turbocharger, *Turbine Size*, or *A/R* ratio should be changed to eliminate this condition.

Choke: (Centrifugals, Turbos) While **Choke** can apply to both the Compressor and Turbine impellers (in turbocharger applications), **Choke** most often refers to the point at which compressor wheel tips reach sonic velocity, preventing further flow. The choke line on a compressor map can be recognized by the steeply descending speed lines at the right side of the map. If choke is detected at any point during the engine rpm range, the **Choke Indicator** will turn from green to yellow, indicating a condition that should be corrected. However, choke problems are relatively easy to correct, often disappearing with a slight reduction in shaft speed (use a larger Turbo or *Turbine Size*, and/or increase the *A/R* ratio).

This turbo compressor map, produced by the manufacturer, shows how the compressor turbine performs at various flow rates, pressure ratios, and rpms. If insufficient engine demand causes the turbo to operate “off the map” to the left, **Surge** can occur. If engine demand line pushes off the right side of the map, the turbo is said to be in a **Choke** condition. And if the turbocharger speed exceeds its maximum rpm, as shown on the map (in this case slightly above 200,000rpm), an **Overspeed** condition exists. Each of these abnormal operating conditions will turn a forced-induction indicators from green to yellow, and if the condition occurs at multiple rpm points or is well beyond the limit, the indicator will turn red.

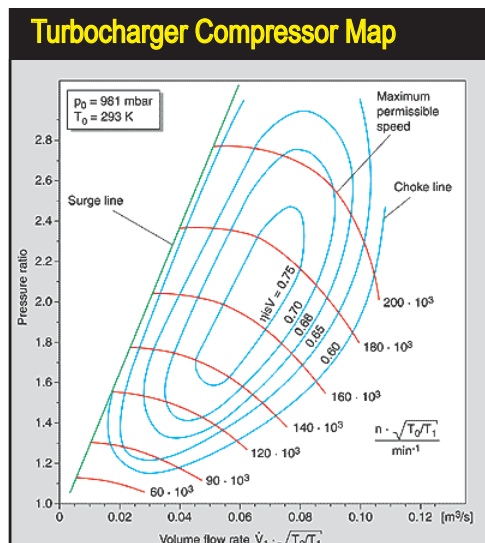

Induction Category (Forced Induction)

Overspeed: (Centrifugals, Turbos) If the shaft speed exceeds the manufacturer's recommendations (the engine demand line travels off of the top of the compressor map), the **Overspeed Indicator** will change from green to yellow. If the overspeed condition exceeds the manufacturer's recommended speed by over 10%, the indicator will switch from yellow to red, indicating a potentially harmful condition to the turbocharger bearings and seals. If you are simulating a turbocharger system and you have a red *Overspeed* condition, increase the *Turbine Size* and/or the *Turbine Housing A/R* ratio.

Important Note: If overspeed occurs in a real supercharging system, you risk destroying the compressor and spraying metal particles into your engine.

Selecting The Best Supercharger For Your Application

Selecting a Turbocharger—A turbocharger consists of a compressor and a turbine. The “compressor side” characteristics are established when you choose the turbo from the main **Blower Type** menu. The compressor acts as pump that forces air into the induction system. The output of the compressor is determined by the speed of the impeller (inside the compressor housing), the shape of the

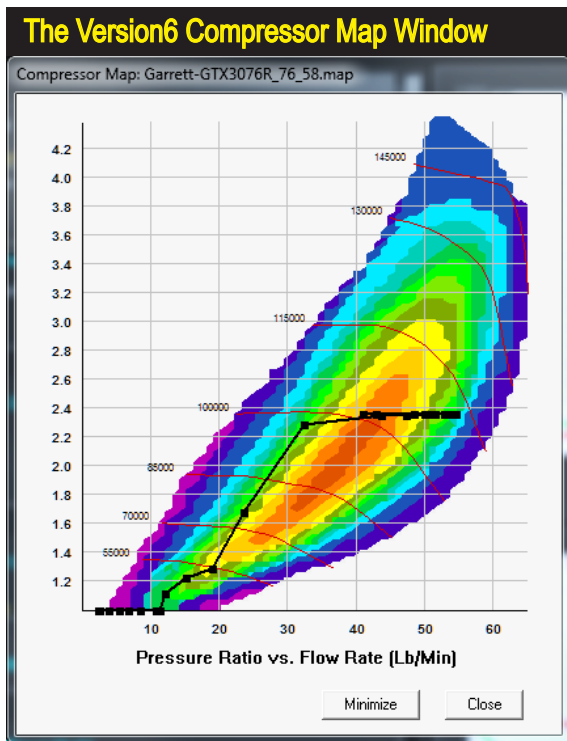

The compressor map display window in the simulation can be viewed by choosing *Show Turbo/Centrifugal Compressor Map* from the Simulation Menu. The left vertical axis shows the output pressure ratio (2.0 equals 2 atmospheres of pressure; about 15 psi of boost). The bottom horizontal axis is the mass flow through the compressor in pounds per minute (Lb/Min). The small numbers positioned along the left edge of the map are the rpm values for the red speed lines. The black line on the graph is the calculated engine demand line; the dots indicate the mass flow at each rpm test point (also displayed in the ProTools table). You can move the map window to any position on your desktop. Use the *Minimize* button to temporarily “park” the window to a tab that appears at the bottom of the program screen; to re-display the window, click the parking-tab.

Induction Category (Forced Induction)

housing, and the swallowing capacity of the engine. These variables are visually illustrated on a compressor map. The simulation incorporates more than 100 turbo maps within its library that cover a wide range of capacities.

The turbine side of the turbocharger is composed of a turbine wheel and the surrounding housing. The turbine is placed in the exhaust stream of the engine and is driven by a combination of exhaust flow and exhaust pressure waves. The turbine is connected to the compressor impeller through an interconnecting shaft. Two principal parameters modify the performance of the turbine: 1) the **Turbine Size** and, 2) the **Turbine A/R** ratio. As described earlier, the **Turbine Size** has a major effect on turbine and compressor speed. In general, the smaller the wheel, the faster the turbine will rotate. The **Turbine A/R** ratio acts to fine-tune the turbine speed. The smaller the **Turbine A/R**, the more quickly the turbo will “spool up.”

To find the optimum turbocharger for your engine, first select a basic turbo/compressor (turbocharger) from the **Blower Type** menu. For help in making an initial selection, consult with the turbo manufacturer or visit the many performance websites that offer turbo kits and performance modifications. You will often find turbo recommendations and even suggestions for turbine-wheel diameters and A/R ratios. After you have selected the basic turbo, set the **Boost Limit** (wastegate pressure) to the desired level (use 10psi if you're not sure). Next, you'll need to analyze how much airflow the turbo is delivering to the engine by viewing the manifold pressure curve (right-click the rpm-based graph, located on the top-right of the main screen, and assign **Boost Pressure** to either the **Y1** or **Y2** axis).

Inspect the manifold pressure curve for the rpm point at which the pressure rises to a maximum. Make sure that the turbo you have selected, in fact, reaches the wastegate relief pressure chosen in the **Boost Limit** field.

Note-1: The simulation can display either *Boost Pressure* and/or *Absolute Pressure*. If the graph pressure curve is an *absolute* pressure plot, remember to subtract ambient pressure to determine boost pressure (for example, an absolute pressure of 25psi would indicate a boost pressure of about 10psi—25psi absolute, minus 14.7psi ambient, equals 10.3psi boost).

Note-2: The mass flow rate of the engine is displayed in the ProTools graph. This value is helpful in selecting a supercharger or a turbocharger, since the mass flow rate is also shown on the blower map and plotted as dots on the demand line. Pick a turbo that has a maximum flow somewhat greater than the highest value of engine demand, otherwise the turbo may enter a restrictive “choked flow” state at full load.

If the maximum-boost rpm point occurs considerably late in the rpm range, the boost pressure may never reach the *Boost Limit*, or if the **Choke** indicator is illuminated, installing a larger compressor may solve the restriction problem. On the other hand, if the boost pressure curve begins too early in the rpm range, or the **Surge** or **Overspeed** indicators are red, installing a larger turbine wheel or increasing the A/R ratio may solve the problem.

Induction Category (Forced Induction)

Centrifugal Supercharger

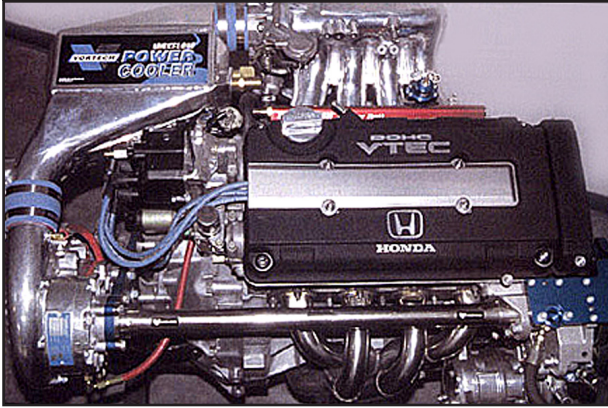

Like a turbocharger, a centrifugal supercharger uses a compressor wheel, but the driving force comes from an internal gear box connected to the engine crankshaft. Because the centrifugal compressor also must rotate at high speed, the internal “step-up” gear increases input pulley speed by up to four times.

Selecting a Centrifugal Supercharger—Like a turbocharger, a centrifugal supercharger consists of a compressor wheel and housing, but the driving force comes from the engine crankshaft through a drive belt or direct coupling and an internal gear box. Also like the turbocharger, the centrifugal compressor has performance characteristics defined in a “map” provided by the manufacturer. Because the centrifugal compressor turbine also must rotate at high speed, an internal “step-up” gear typically increases input pulley speed by several times. And input speed is often 1.5- to 3-times engine speed, determined by the appropriately sized pulleys. Final impeller speed is found by multiplying the *Internal Ratio* by the *Belt Ratio* and multiplying the result by engine *RPM*.

Note: While the internal gear ratio is not usually changeable, the simulation gives you the freedom to experiment with this ratio in addition to all the other tunable elements in the **Forced Induction** category.

Belt Ratio can be calculated using the following formulas:

For Serpentine and V-Belts:

$$\text{Belt Ratio} = \frac{\text{Crank pulley diameter}}{\text{Supercharger pulley diameter}}$$

For Cog Pulleys:

$$\text{Belt Ratio} = \frac{\text{Crank pulley teeth count}}{\text{Supercharger pulley teeth count}}$$

To find the optimum centrifugal supercharger for your engine, first select a centrifugal supercharger from the menu. For help in making an initial selection, consult with the manufacturer’s website or visit the numerous performance sites that offer kits and performance modifications. You will often find supercharger recommendations and suggestions for belt ratios. After you have selected the basic blower, set

Induction Category (Forced Induction)

the **Boost Limit** (wastegate pressure) to the desired level (use 10psi if you're not sure). Next select the **Belt Ratio** and set the **Internal Gear Ratio** to the values used by the manufacturer (many centrifugal blower run with approximately 2.5:1 external **Belt Ratios** and 3.5:1 **Internal Gear Ratios**). Finally, you'll need to analyze how much airflow the blower is delivering to the engine by viewing the manifold pressure curve (right-click the rpm-based graph on the top, right of the main program screen and assign **Boost Pressure** to either the **Y1** or **Y2** axis).

Inspect the manifold pressure curve for the rpm point at which the pressure reaches the maximum boost pressure. Check that the supercharger you have selected, in fact, reaches the wastegate relief pressure chosen in the **Boost Limit** field.

Note: The simulation can display either **Boost Pressure** and/or **Absolute Pressure**. If the graph pressure curve is an *absolute* pressure plot, remember to subtract ambient pressure to determine the boost level (for example, an absolute pressure of 25 psi would indicate a boost pressure of about 10psi; 25psi absolute minus 14.7psi ambient equals 10.3psi boost).

If the maximum-boost rpm point occurs considerably late in the rpm range, or if the boost pressure never reaches the **Boost Limit**, increasing the **Belt Ratio** or installing a larger supercharger may solve the problem. On the other hand, if the pressure curve rises early in the rpm range, or the **Surge** or **Overspeed** indicators are lit, try decreasing the **Belt Ratio** or installing a smaller supercharger.

Selecting a Roots or Screw Supercharger—Roots or Screw-type supercharger selection involves only two parameters: the flow volume and the **Belt Ratio** (these superchargers usually do not have internal overdrive gear boxes). The compressor-flow volume is fixed in the design of the supercharger and is indicated in the blower menu as a volume-per-revolution value.

Inspect the manifold pressure curve (use the Graph Options Menu to assign boost pressure to either the Y1 or Y2 axis) for the rpm point at which the pressure rises to the maximum boost pressure. This display will show you if, in fact, the selected turbo reaches the wastegate relief pressure set in the **Boost Limit** field. Here, the green curve indicates that a boost pressure of about 19psi is reached at about 5000rpm.

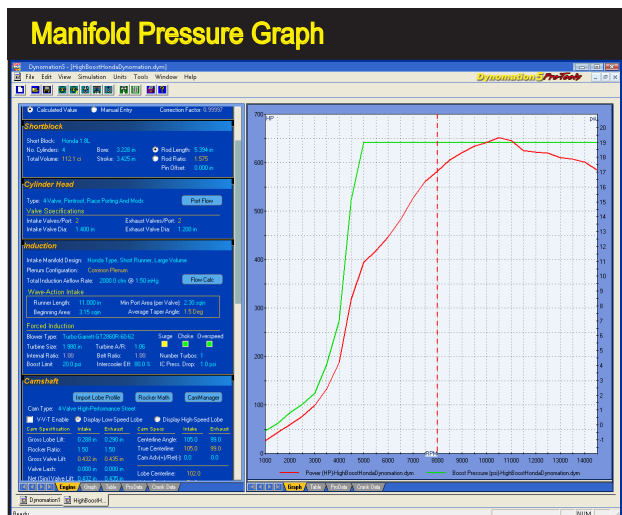

Induction Category (Forced Induction)

Roots Supercharger



The roots supercharger is a positive displacement “pump.” It really doesn’t compress air, rather it pushes “measured chunks” air into the engine. It employs 2 or 3 counter-rotating lobes to capture a fixed volume of air per revolution and deliver it to the intake manifold. Unlike the compressors of the turbocharger and centrifugal supercharger, a positive displacement supercharger pumps a steady amount of air for every revolution. When properly setup, it can deliver “instant boost” even at low speed. This compact setup is a Jackson high-boost system for the Honda Civic Si.

To find the optimum Roots/Screw supercharger for your engine, first select a supercharger from the menu. For help in making an initial selection, consult with the manufacturer’s website or visit the numerous performance sites that offer kits and performance modifications. You will often find supercharger recommendations and suggestions for belt ratios. After you have selected the basic blower, set the **Boost Limit** to the desired level. Remember that the **Boost Limit** is simply the blowoff-valve pressure; the maximum pressure *limit* for the induction system. The *Boost Limit* is not the “guaranteed” pressure the blower will generate; improper sizing or belt ratios, even altitude will lower maximum blower pressures. Next select the **Belt Ratio** recommended by the manufacturer (many Roots blowers use *Belt Ratios* of 1.0- to 1.5:1, while Screw superchargers use approximately 1.5- to 2.0:1). Finally, you’ll need to analyze how much airflow the blower is delivering to the engine by viewing the manifold pressure curve (right-click the rpm-based graph on the top-right of the main program screen and assign **Boost Pressure** to either the **Y1** or **Y2** axis).

Inspect the manifold pressure curve for the rpm point at which the pressure rises to the desired level. For optimum efficiency, make sure that the roots or screw supercharger you have selected does not quite reach wastegate pressure (*Boost Limit*) within the usable rpm range of the engine (if it does, you may need to select a smaller blower or reduce the *Belt Ratio*). However, manifold pressure should reach a sufficient level to provide the desired performance improvement.

Note: The simulation can display either *Boost Pressure* and/or *Ambient Pressure*. If the graph pressure curve is an *absolute* pressure plot, remember to

Induction Category (Forced Induction)

Screw Supercharger

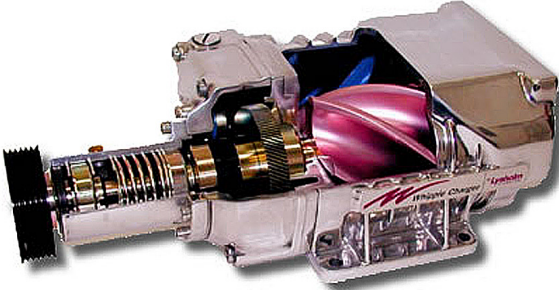

The screw compressor (like this model from *Whipple*) uses a positive-displacement design for excellent low-end torque as well as high efficiency for good top-end horsepower.

subtract ambient pressure to determine boost pressure (for example, an absolute pressure of 25 psi would indicate a boost pressure of about 10psi—25psi absolute, minus 14.7psi ambient, equals 10.3psi boost).

If the desired boost pressure occurs considerably late in the rpm range or the desired pressure is never reached, try a larger supercharger or increase the *Belt Ratio*. On the other hand, if the pressure curve rises too quickly, or the *Boost Limit* pressure is reached within the usable rpm range of the engine, decrease the *Belt Ratio* or install a smaller supercharger.

Note: The *Surge*, *Choke*, and *Overspeed* indicators are not active when Roots or Screw superchargers are used.

Intercoolers

One of the drawbacks to any method of supercharging is the resulting increase in induction-gas temperatures. High boost pressures can quickly raise charge temperatures more than 200-degrees(F)! These higher temperatures, common on blowers with pressure ratios of 2.0 or higher, cost more than just lost horsepower. Higher temperatures can lead to detonation, increase octane requirements, and usually require a reduction in ignition timing advance. While induction cooling can improve performance directly from increased charge density (more oxygen and fuel per unit volume of inducted charge), the additional benefits of reduced detonation and increased reliability make charge cooling an attractive addition to any supercharged high-performance engine.

Charge cooling is accomplished in the same way that heat is removed from the engine. A radiator, called an intercooler, is placed in the pressurized air ducting between the supercharger and the intake manifold. The efficiency of an intercooler determines how much of the heat generated by charge compression is removed. The lower the efficiency of the intercooler, the less heat is removed from the induction charge. An efficiency of 100% removes all extra heat (brings charge temperature

Induction Category (Forced Induction)

Intercooler And Pressure-Drop Menu

Forced Induction Specifications:
 Compressor: Turbo-Garrett-GTX3071R-71-58
 Turbine Size: 2.800 in Internal Ratio: 1.00 Surge Choke Overspeed
 Turbine A/R: 0.70 Belt Ratio: 1.00
 Number Turbos: 1
 Boost Limit: 20.0 psi 1.0

Camshaft
 Fitter Import Lobe Profile
 Cam Type: V-V-T Street Cam
 V-V-T Enable Display L
 In Profile: None

Cam Specification	Intake	Exhaust	Additional Ca
Gross Lobe Lift:	0.220 in	0.203 in	Lobe CL (Int b
Rocker Ratio:	1.50	1.50	Valve Overlap
Gross Valve Lift:	0.330 in	0.305 in	Cam Accel Ra
Valve Lash:	0.020 in	0.020 in	Variable Valve
True Lift @ Valve:	0.310 in	0.285 in	V-V-T Activat
Modeled From:	10-Point	10-Point	V-V-T LOW SPI

Desired Cam Timing (Modeling Input)
 (Valve) Primary (0.006-in) Timing: -6.5 44.5 46.5 4.5

Efficiency Menu:
 None
 1 psi / 0.069 bar
 2 psi / 0.138 bar
 3 psi / 0.207 bar
 4 psi / 0.276 bar
 5 psi / 0.345 bar
 10% Efficiency
 20% Efficiency
 30% Efficiency
 40% Efficiency
 50% Efficiency
 60% Efficiency
 70% Efficiency
 80% Efficiency
 90% Efficiency
 100% Efficiency
 110% Efficiency
 120% Efficiency
 130% Efficiency
 140% Efficiency
 150% Efficiency

The simulation includes an *Inter-cooler* model that can be activated with any forced-induction system. An intercooler reduces high induction temperatures that can substantially reduce performance. The *Intercooler* is selected from a menu that indicates efficiency; 100% efficiency reduces induction temperature to ambient. An *IC Pressure Drop* menu shows an estimated pressure drop value based on the Intercooler efficiency (due to increased charge density from charge cooling).

down to ambient). An efficiency of over 100% (reduces charge temperatures below ambient) is possible with water or ice. Everything from outside air to ice water and even evaporating pressurized liquefied gas (like Freon or nitrous oxide) have been used to remove heat from an intercooler. The ballpark efficiencies for these devices are:

Air-To-Air	40%	Air-To-Cooler Ducted Air	50%
Air-To-Water	75%	Air-To-Cooled Water	100%
Air-To-Ice Water	120%	Air-To-Evaporating Liquid	120+%



Higher induction temperatures, common on blowers with pressure ratios of 2.0 or higher, can cost horsepower and reliability. An Intercooler cools the inducted air the same way that heat is removed from the engine itself: with a radiator. Intercooling is the key to power and reliability in high-boost systems.

Induction Category (Forced Induction)

Intercooled VW Golf



Here's a great ride! This turbocharged Golf uses a generously-sized intercooler. Note the cold-air inlet ducted to the hood/cowl. The clear front end is awesome—this shot was taken with the hood closed!

The simulation includes an intercooler model that can be activated with any forced induction system. Simply double-click on the **Intercooler** field and select an intercooler efficiency from the drop-down list (or directly enter a custom value).

Every intercooler will produce a pressure drop generated by its restriction and the increased charge density within the intercooler. This pressure drop is usually small—in the range of 1 to 3 psi. You can adjust the Intercooler Pressure Drop by selecting a value from the **IC Pressure Drop** menu, or let the simulation automatically calculate an estimated pressure drop value based on the selected Intercooler.

Note-1: The **IC Pressure Drop** occurs after the Intercooler, so the **Boost Limit** may need to be increased to obtain the desired boost pressure at intake valve.

Note-2: When methanol evaporates, it cools the intake charge more than gasoline (the latent heat of vaporization of methanol is much greater than gasoline and the volume of *methanol* used is also greater). Therefore, intercooling is less effective when methanol is used (especially if it is injected well before the intake valve in the intake runners, allowing the fuel to fully atomize and drop in temperature).

Camshaft Category

Camshaft Category

Camshaft

Cam Type: **Custom**

V-V-T Enable
 Display Low-Speed Lobe
 Display High-Speed Lobe

In Profile: None Ex Profile: None

Cam Specification	Intake	Exhaust	Additional Cam Specifications	
Gross Lobe Lift	0.582 in	0.566 in	Lobe CL (Int to Exh): 110.0	
Rocker Ratio:	1.75	1.60	Valve Overlap: 106.0	
Gross Valve Lift:	1.018 in	0.905 in	Cam Accel Rating: 5.87	
Valve Lash:	0.000 in	0.000 in		
True Lift @ Valve:	1.018 in	0.905 in	Variable Valve Timing Activation	
Modeled From:	10-Point	10-Point	V-V-T Activation: 5000 rpm	

Desired Cam Timing (Modeling Input)		IVD	IVC	EVD	EVC
(Valve)	Primary (0.006-in) Timing:	54.0	84.0	102.0	52.0
(Valve)	Primary 720-Based Timing:	306.0	624.0	78.0	412.0
(LOBE)	Secondary (0.050-in) Timing:	37.5	67.5	83.0	33.0
(LOBE)	Secondary 720-Based Timing:	322.5	607.5	97.0	393.0
(Valve)	Rocker-Math Timing Changes:	0.0	0.0	0.0	0.0
(LOBE)	Centerline (Max Lift to TDC):	105.0		115.0	
(LOBE)	Cam Advance(+)/Retard(-):	0.0		0.0	

True Cam Timing (Measured Values)		IVD	IVC	EVD	EVC
(Valve)	Timing @ 0.006-in Valve Lift:	54.0	84.0	102.0	52.0
(LOBE)	Timing @ 0.050-in Lobe Lift:	37.5	67.5	83.0	33.0
(LOBE)	Camshaft Ramp Dynamics:	<input checked="" type="checkbox"/>	<input checked="" type="checkbox"/>	<input checked="" type="checkbox"/>	<input checked="" type="checkbox"/>
(Valve)	Acceleration Rates:	6.79		5.15	
(Valve)	Centerline Angle (Weighted):	105.0		115.0	

Other True Timing Measurements			
(Valve)	Duration @ 0.006-in Valve Lift:	318.0	334.0
(LOBE)	Duration @ 0.050-in Lobe Lift:	285.0	296.0
(Valve)	Duration @ 0.050-in Valve Lift:	293.0	304.0
(Valve)	Timing @ 0.050-in Valve Lift:	42.0	37.0

The **Camshaft Category** establishes one of the most important specifications in the engine: **Intake And Exhaust Valve-Event Timing** that dictates the beginning and ending of all four engine cycles. The **Camshaft Category** organizes and labels the numerous timing specifications that define cam design and helps you visualize their effect on engine performance. In addition, the simulation includes many features and tools that will help you find optimum cam-timing for just about any engine application.

THE CAMSHAFT CATEGORY

Applies To FE and WA Simulations, Except as Indicated

The **Camshaft** component category lets you select and modify one of the single most important components of the engine. For many enthusiasts and even professional engine builders, the subtleties of cam timing defy explanation. And, considering the various “standards” of measurement and pervasive advertising hype, the reason for the confusion is understandable.

The camshaft is often called the “brains” of the engine, directing the beginning and ending of all four engine cycles. Even with a good understanding of engine systems, the interrelatedness of the dynamic processes within the IC engine can make the results of cam timing changes read like a mystery. In many cases there are only two ways to determine the outcome of a modification: 1) run a real dyno test, or 2) run a simulation of the flow dynamics of the engine. Since the camshaft directly affects several functions at once, e.g., the flow of the exhaust and intake gases, the reverse (or reversion) flow in intake and exhaust passages, cylinder

Camshaft Category

pressures, etc., using a computer engine simulation is the only practical way to keep track of all these variables and accurately predict the outcome.

The Camshaft Category: A Quick Overview

The **Camshaft Category** in this Version-6 simulation has several enhancements over previous program versions. The most important changes are: 1) The use of new algorithms (collectively called the “Fitter”) that mathematically generate very precise valve lift data used by simulation, and 2) 0.050-inch valve timing (secondary timing points) are used, along with primary (seat-to-seat) timing values, as the “controller” of lifer and valve acceleration rates. If you wish to change the cam/lifter acceleration, you use the same methods as all cam manufacturer’s: *by changing the primary and secondary valve timing*. As a result, valve acceleration rate fields are now measured values (will only change when cam timing is changed). The overall result of these changes is that entering and testing camshaft specs better represents real-world camshaft design and testing practices.

We will explore all the features available the **Camshaft Category** in this chapter, however, let’s begin by looking at basic cam data input and the analysis provided

The **Camshaft Category** is divided into two functional groups: 1) **Cam Modeling Data In, From User Input**, and 2) **Cam Modeling Results, Measured During Sim Calculations**. The **Data In** group contains the input fields you use to specify the desired timing, lift and other values for the current camshaft (or multiple camshafts in VVT...variable valve timing... applications). These data-input fields are displayed in Cyan (in the default color scheme). In the **Results** group, the simulation displays the outcome of a mathematical analysis of input data and gives you precise feedback about possible problems or inconsistencies. If the **Data In** matches the **Data Out**, the camshaft was precisely modeled (to within 0.5 crank degrees) and this data was used to actuate valve motion within the simulation run. Details on how to get the most from the new **Camshaft Category** are provided in this section of the **User Manual**.

Data Input, True Data From Sim

Camshaft

Filter Import Lobe Profile Rocker Math 10-Point CamManager

Cam Type: VVT-Street Cam

VVT-Enable Display Low-Speed Lobe Display High-Speed Lobe

In Profile: None Ex Profile: None

Cam Modeling Input

Gross Lobe Lift:	0.220 in	0.293 in	Lobe CL (Int to Exh):	113.5
Rocker Ratio:	1.50	1.50	Valve Overlap:	-13.0
Gross Valve Lift:	0.330 in	0.305 in	Cam Accel Rating:	2.57
Valve Lash:	0.020 in	0.020 in	Variable Valve Timing Activation	
True Lift @ Valve:	0.310 in	0.285 in	VVT Activation:	4500 rpm
Modeled From:	10-Point	10-Point		

		VVT	LOW SPEED	Cam	
Desired Cam Timing (Modeling Input)		IVO	IVC	EVO	EVC
(Valve)	Primary (0.006-in) Timing:	-6.5	44.5	46.5	4.5
(Valve)	Primary 720-Based Timing:	366.5	584.5	133.5	364.5
(LOBE)	Secondary (0.050-in) Timing:	-25.0	29.5	20.0	-21.0
(LOBE)	Secondary 720-Based Timing:	385.0	569.5	160.0	339.0
(Valve)	Rocker-Math Timing Changes:	0.0	0.0	0.0	0.0
(LOBE)	Centerline (Max Lift to TDC):		117.0		110.0
(LOBE)	Cam Advance(+)/Retard(-):		0.0		0.0

Cam Modeling Results

True Cam Timing (Measured Values)		IVO	IVC	EVO	EVC
(Valve)	Timing @ 0.050-in Lobe Lift:	-25.0	29.5	20.0	-21.0
(LOBE)	Camshaft Ramp Dynamics:				
(Valve)	Acceleration Rates:		3.31		2.11
(Valve)	Centerline Angle (Weighted):		117.0		110.0

Other True Timing Measurements

(Valve)	Duration @ 0.006-in Valve Lift:	208.0	208.0		
(LOBE)	Duration @ 0.050-in Lobe Lift:	184.5	179.0		
(Valve)	Duration @ 0.050-in Valve Lift:	186.0	181.0		
(Valve)	Timing @ 0.050-in Valve Lift:	-24.0	30.0	21.0	-20.0

Camshaft Category

by the new *Fitter* algorithms.

The *Camshaft Category* is, overall, divided into two groups: 1) **Cam Modeling Data In (user input)** located in the upper portion of the category, and 2) **Cam Modeling Results (true timing measured during the simulation run)** shown in the lower part of the category. The *Data In* group displays the desired cam timing, lift and other values for the camshaft (or multiple camshafts in VVT...*variable valve timing*...applications). This camshaft data-inputs are displayed in Cyan (for the default color scheme). The *Results* group displays an analysis of camshaft data measured during the simulation run, including feedback about cam modeling accuracy and possible issues or inconsistencies. If the displayed *Data In* values match the *Modeling Results*, the camshaft was precisely simulated (to within 0.5 crank degrees) and the generated valve-lift curve will exactly pass through the primary and secondary timing points and the point of maximum lift.

The *Results* group shows the actual, measured timing and duration values for the currently simulated camshaft. If you compare the **(Valve)—Primary (0.006-in) Timing** values in the *Modeling Input* group with the measured **(Valve)—Timing @ 0.006-in Valve Lift** in the *Measured Values* group, the values should match (as should the 0.050-inch timing values). If they do, it means that the requested cam timing was exactly simulated. If there are differences, one or more of the **Camshaft Ramp Dynamics** indicators may turn yellow or red (details of cam modeling problem(s) can be found in the *Simulation Log*; open the *Log* from the **Simulation** menu; at the top of the main program screen). Yellow (or in severe cases, red) indicates

The camshaft is a round shaft incorporating *cam lobes*. The *base circle diameter* is the smallest diameter of each lobe. *Clearance ramps* form the transition to the *acceleration (or flank) ramps*. The lifter accelerates up the clearance and acceleration ramps and continues to rise as it approaches the *nose*, then slows to a stop as it reaches maximum *lift*, often at the *lobe centerline*. Maximum *lifter rise* is determined by the height of the *toe* over the *heel*. *Valve-open duration* is the number of crankshaft degrees that the valve or lifter is held above a specified height (usually 0.006-, 0.020-, or 0.050-inch). A symmetric lobe has the same opening and closing lift profile.

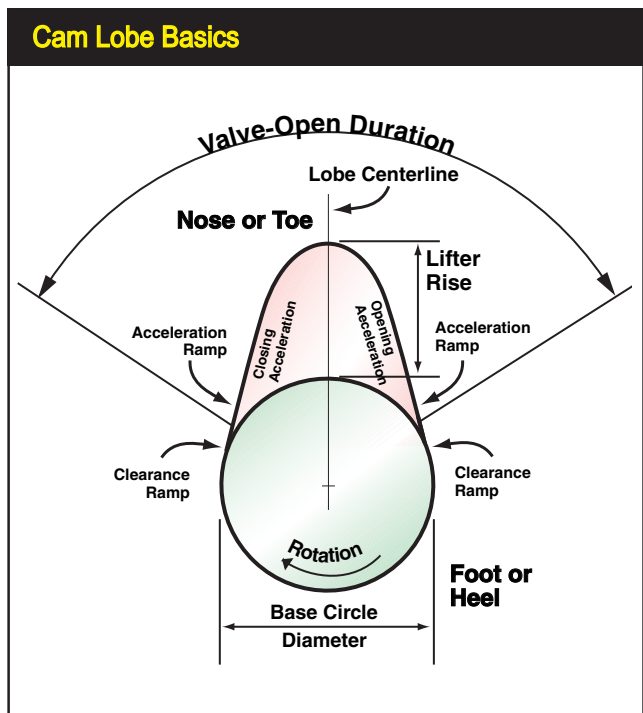

Camshaft Category

that it was not possible for the simulation to produce a lift curve with precisely the valve-event timing that was requested.

Before we delve more deeply into the *Camshaft Category* and cam modeling in the simulation, it's essential that we cover 10-point cam timing vs. lobe-profile timing.

Cam Basics

Most camshafts are steel or iron shafts with eccentric lobes. They are mechanically driven by the crankshaft, typically by a chain or gear train and are usually rotated at one-half crank speed. Lifters (or cam followers)—and for in-block cam locations, pushrods, and rockerarms—translate the rotary motion of the cam into an up-and-down motion that opens and closes the intake and exhaust valves. This entire assembly must function with high precision and high reliability. Street engines driven hundreds-of-thousands of miles operate their valvetrain components *multiple billions of cycles*. And after all that use, if the overall camshaft and valvetrain embody a solid design, a precision measurement will detect only negligible wear!

The camshaft controls valve opening and closing points by the shape and rotational “index” of the lobes (position relative to each other and the crankshaft). Most cams are ground to a precision well within one crankshaft degree, ensuring that valves actuate exactly when intended. However, timing variations of several degrees

Valve-Motion Diagram Shown In The CamManager™

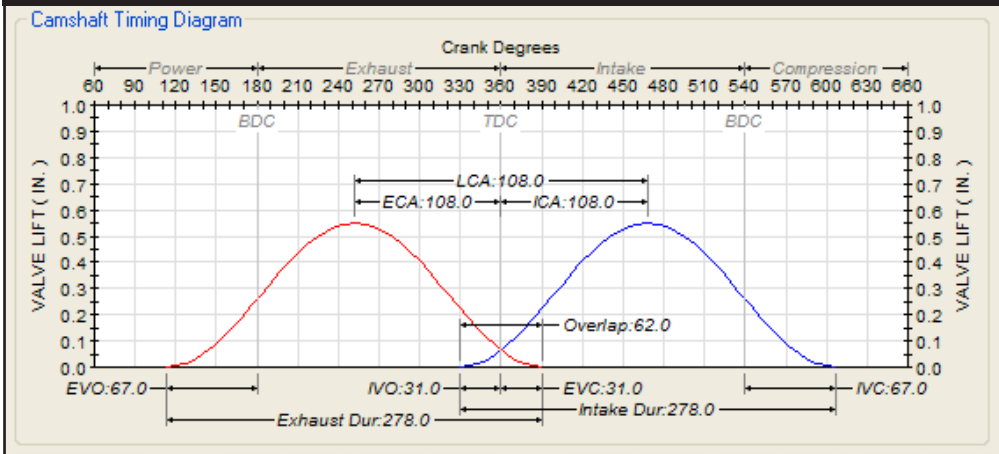

The best way to visualize camshaft timing in a running engine is to picture this “twin-hump” *Valve-Motion* diagram (drawn “on the fly” in the *CamManager*™). You can see valve motion for the exhaust lobe on the left and the intake lobe on the right. Also illustrated are the valve-timing points, duration, valve overlap, valve lift, centerlines, lobe center angle, and “ideal” engine-cycle timing, all relative to TDC at the center of the drawing. Study this picture and the text in this section to help you visualize the intricacies of cam-timing specifications.

Camshaft Category

7—Intake Duration

9—Lobe-Center Angle (LCA)

11—Intake-Center Angle (ICA)

8—Exhaust Duration

10—Valve Overlap

12—Exhaust-Center Angle (ECA)

Almost all of these valve-timing events can be measured and modeled in several ways. The most common methods are used in the simulation and are described below.

Seat-To-Seat (VALVE) Timing

This valve-event timing method measures the valve events in degrees—relative to piston position—when the valve has only just begun to rise or has *almost* completely returned to the valve seat. While, there is more than one “standard” seat-to-seat measuring method used in the automotive industry, these are the most common timing methods at which both intake and exhaust valve-events are said to begin or end:

0.004-inch LIFTER Rise (SAE Standard)

0.006-inch VALVE Rise (SAE Standard)

0.007-inch open/0.010-close VALVE Rise

0.010-inch VALVE Rise

0.020-inch LIFTER Rise (commonly used in *solid-lifter* applications)

The valve-event timing measured using these methods is meant to approximate the actual valve “opening-and-closing” points that occur within the running engine. Because of this, seat-to-seat valve events are often called the *advertised* or *running* timing. The simulation uses this event information to fix the beginning and end of

Seat-to-seat timing measures valve-event timing—relative to piston position—when the valve has just begun to open (usually at 0.006-inch valve rise). This is measured during engine assembly by positioning dial indicators on the valve-spring retainers and measuring valve rise, which is the most common definition of seat-to-seat timing. Timing specs measured using these methods are meant to approximate the actual valve opening and closing points that occur within the running engine. Because of this, Seat-To-Seat valve events are often called the *running* (or *advertised*) timing.

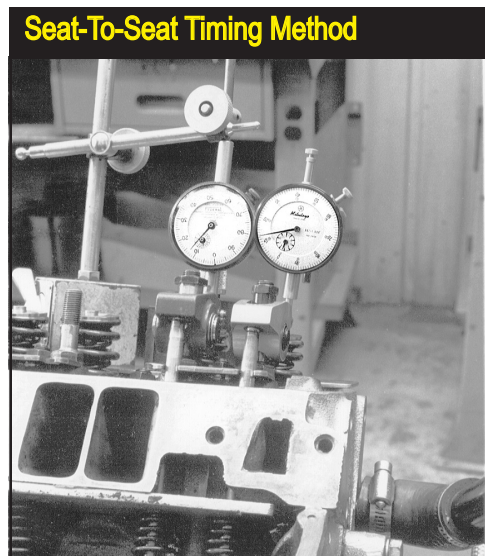

Camshaft Category

0.050-Inch Timing

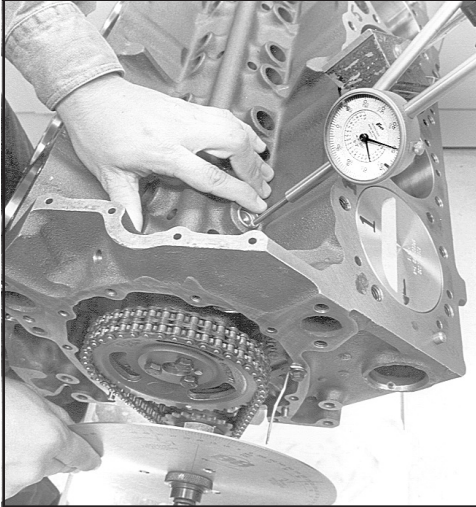

The *0.050-inch Lifter (LOBE) Rise* valve-event timing measures timing (relative to the crankshaft) when the lifter has risen 0.050-inch off of the base circle of the cam. In the setup pictured here, a dial indicator is positioned on an intake lifter; the 0.050-inch timing point can now be read directly off of the degree wheel attached to the crankshaft. *Note that valve lash and rocker ratio play no part in LOBE Timing measurements. Lobe-lift timing was not originally meant to approximate the valve opening and closing points, instead its purpose was to permit accurate cam installation. But now it is commonplace to use both Primary and Secondary timing to evaluate the appropriateness of camshaft for any application.*

mass flow into and out of the ports and cylinders, a crucial step in the process of determining cylinder pressures and power output.

Note: While there is an accepted seat-to-seat measuring standard (the SAE *0.004-inch Lifter Rise* or *0.006-inch Valve Rise* methods), unfortunately there is also a great deal of variation from this standard among cam manufacturers for “cataloging” or “advertising” purposes. These variations can easily confuse anyone trying to determine actual timing specifications. If you use the seat-to-seat timing specs that fall into any of the categories discussed above, you should obtain accurate results. *Any seat-to-seat timing specifications obtained at substantially more or less than 0.006-inch Valve Rise will not produce ac-*

Primary (0.006-in) and Secondary (0.050-in) Cam Timing Data Entry

Desired Cam Timing (Modeling Input)		IVO	IVC	EVO	EVC	
(Valve)	Primary (0.006-in) Timing:	54.0	84.0	102.0	52.0	
(Valve)	Primary 720-Based Timing:	306.0	624.0	78.0	412.0	
(LOBE)	Secondary (0.050-in) Timing:	37.5	67.5	83.0	33.0	->STS
(LOBE)	Secondary 720-Based Timing:	322.5	607.5	97.0	393.0	
(Valve)	Rocker-Math Timing Changes:	0.0	0.0	0.0	0.0	Reset

The simulation requires both Primary (0.006-inch Valve Lift) and Secondary (0.050-inch Lobe Lift) cam-timing points. These data entry fields are shown cyan, above. Both groups of valve-timing events (and lift, rocker ratio and valve lash) are needed to perform a simulation and calculate the *Measured Timing* values displayed in the lower portion of the Camshaft Category (shown earlier in this section).

Camshaft Category

Extrapolating Seat-To-Seat Event Timing

The screenshot shows a software interface with a table of camshaft timing data. A red arrow points to the '>STS' button next to the Secondary (0.050-in) Timing row. A warning dialog box is overlaid on the table, asking for confirmation to overwrite current values with extrapolated values.

Desired Cam Timing (Modeling Input)	IVO	IVC	EVO	EVC
(Valve) Primary (0.006-in) Timing:	54.0	84.0	33.0	52.0
(Valve) Primary 720-Based Timing:	306.0	624.0	78.0	0
(LOBE) Secondary (0.050-in) Timing:	37.5	67.5	83.0	33.0
(LOBE) Secondary 720-Based Timing:	322.5	607.5	97.0	393.0
(Valve) Rocker-Math Timing Changes:	0.0	0.0	0.0	0.0

Warning!
This will overwrite the current Seat-To-Seat Timing values with those extrapolated from .050-timing points. Do you wish to continue?
OK Cancel

Pressing the ->STS button in the Camshaft category will extrapolate new/updated Seat-To-Seat valve-event timing from the current 0.050-in Secondary values. Use this feature if you only have access to 0.050-in lobe-lift timing data for a particular camshaft.

curate results when using 10-Point cam timing values (discussed below).

0.050-Inch (LOBE) Timing

This timing method is widely used and has been standardized by cam manufacturers. 0.050-inch cam timing points are always measured at: **0.050-inch LIFTER Rise** for both the intake and exhaust valves.

This measurement technique was not originally introduced to help evaluate valve opening-and-closing events, valvetrain acceleration, or cam suitability for a particular application. Rather it was intended to be used as an accurate **index** of cam-to-crank position during cam installation. Because of this, it is based on the movement of the cam follower (lifter) rather than the valve, eliminating valve lash and rocker ratio when measuring cam-to-crank timing. Since the follower will be positioned within the cam **acceleration ramp** at 0.050-inch lobe lift, and will have begun rapid movement up the lobe flank, using this point provides good way to verify the precise rotational index of the camshaft relative to the crankshaft. Although 0.050-inch valve timing events do not pinpoint when the intake and exhaust valves open or close, they provide valuable data for the simulation to mathematically model acceleration rates and to generate an accurate valve lift curve.

Important Note: Keep in mind that 0.050 Lobe Lift points (also called Secondary Timing) do NOT change when the rocker ratio or valve lash are altered. These timing points are measured on the cam follower, and only the lobe shape, lifter design, and the rotational-index between the cam and the crankshaft (ICA or ECA) will change Secondary Timing.

If you only have access to 0.050-inch timing data for a particular camshaft, you can still model the valve timing (albeit with somewhat reduced accuracy). Use the **Convert To STS Timing (->STS)** button to have the simulation extrapolate a “best guess” of seat-to-seat timing from the current 0.050-in Secondary values.

Note-1: To optimize accuracy, *whenever possible, use the cam manufacturer’s*

Camshaft Category

“10-Point” Cam Data consists of valve-event timing for both the intake and exhaust lobes at both seat-to-seat and 0.050-inch timing points. These eight values, plus the maximum lift of each lobe, produce 10-data points for each camshaft. The simulation uses 10-Point data to generate a valve-motion curve.

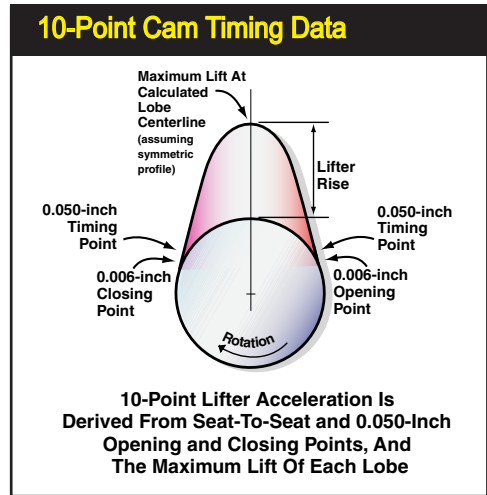

published Seat-To-Seat and 0.050-in Timing values as the basis for 10-Point cam simulations.

Note-2: Using the **->STS** feature is never needed if you are importing *Lobe Profile* files, since both Seat-To-Seat and 0.050-in Lift points are obtained by direct measurement of the imported profile data. More information about *10-Point* cam modeling and how it differs from *Lobe-Profile* modeling is presented next.

Cam Modeling With 10-Point And Lobe-Profile Data

The simulation can use two distinct methods of modeling cam events and generating a valve-motion curve. They are based on: **1) 10-Point Cam Data**, or **2) Lobe-Profile Data**. Here is a quick overview of these methods and how they are used to complete a simulation:

10-Point Cam-Data (CamFiles) consists of *Valve-Event and Lobe-Event Timing* for both the intake and exhaust lobes. These eight values, plus the maximum lift of each lobe, produce 10-data-points for each camshaft. The simulation uses this 10-Point data to accurately extrapolate the entire valve-motion curve. **Profile Lobe Data (Profile Files)** contain a virtual “blueprint” of cam lobes. While *Profile Files* may differ in their content depending on what measuring apparatus was used to analyze cam lobe shapes, they all contain lobe-lift data recorded at discrete rotational increments, typically at each degree of cam rotation (360 points). This profile data can be used as the basis for a valve-motion curve (only interpolation is needed to determine the exact valve lift for any crank positions “between” recorded values in the profile file). Additional information on using and importing *Lobe Profile Files* is presented later in this chapter.

Camshaft Category

Lobe-ProFile Data

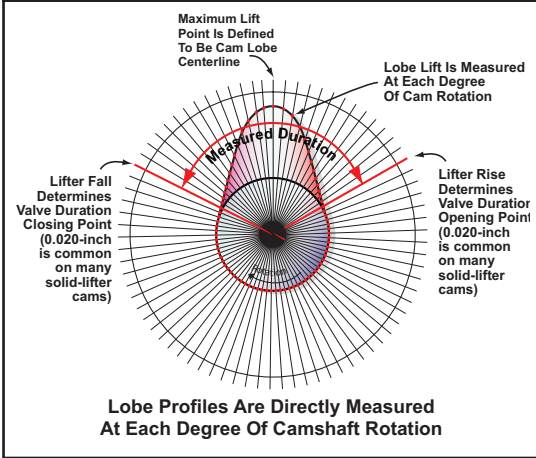

Profile data is made up of lobe-lift data recorded at, usually, each degree of camshaft rotation (by installing the cam in a special fixture designed for this recording process). The simulation can use this data to determine valve positions at any point during the simulation.

You may be asking, “Since the simulation can read Lobe Profile files, why use any other “less precise” cam-data in a simulation”? The answer is: While cam profiles do contain the most accurate valve-motion data for a specific camshaft, using them in an engine simulation has some limitations. When a profile data set is used, modifying individual valve-opening or closing points is next to impossible. For example—just as in the real world—you can advance and retard profile data (for each lobe), change lash, rocker ratio, and that’s about the end of your tuning options. If you would like to test different intake timing (IVO, or IVC independently), your only option is to import a completely different profile using new timing values. Since individual valve-event timing is “baked into” profile data, it can’t be easily

Profile Data Conversion To 10-Point

V-V-T Enable Display Low-Speed Lobe Display High-Speed Lobe

In Profile: Float31.CPP Ex Profile: None

Cam Specification Intake Exhaust Additional Cam Specifications

Gross Lobe Lift: 0.429 in 0.203 in Lobe CL (Int to Exh): 110.0

Rocker Ratio: 1.50 1.50 Valve Overlap: 33.4

Gross Valve Lift: 0.641 in 0.307 in Cam Accel Rating: 2.76

Valve Lash: 0.020 in 0.020 in

True Lift @ Valve: 0.624 in Variable Valve Timing Activation

Modeled From: Profile 10-Point V-V-T Activation: 4500 rpm

Profile Data Used

Convert to 10-Point Timing

Desired Cam Timing (Modelin	Output	IVO	IVC	EVO	EVC
(Valve) Primary (0.006-in) Timing		39.4	84.9	46.5	4.5
(Valve) Primary 720-Based Timing		320.6	624.9	133.5	264.5
(LOBE) Secondary 720-Based Timing		341.4	605.6	160.0	339.0
(Valve) Rocker-Math Timing Changes		0.0	0.0	0.0	0.0
(LOBE) Centerline (Max Lift to TDC)		110.0	110.0		
(LOBE) Cam Advance(+)/Retard(-)		0.0	0.0		

When Cam-Profile data is being used on the intake and/or exhaust valve, it is indicated in the *Modeled From* field. If you would like to use modified valve-event timing, profile data must be converted to 10-Point timing using the *Convert To 10-Point (->10-pnt)* button. When the conversion is complete (engine power should be very similar if the conversion process was successful), you can modify any timing point and test its effect on engine output.

Camshaft Category

changed without “corrupting” the original profile shape. When it comes to profile files, testing various cam-timing combinations requires loading completely different profiles, much the same way you would install a different cam in a real-world dyno test.

The Best Of Both Worlds

10-Point cam data can make cam simulation testing a lot more versatile, especially when you are searching for optimum cam timing for a new application; one for which you may not have done extensive testing or research. 10-Point data sets are just that, 10 data points that the simulation uses to extrapolate a full valve-motion curve (in effect, a new “profile” data set) that establishes valve lift at each crank degree during the simulation process. The 10 points used are: **IVO**, **IVC**, **EVO**, and **EVC**, at both 0.006-in valve lift and 0.050-in lobe lift points...that’s 8 data points...plus the maximum lift for each lobe; that’s 10 data points. This data, readily available on manufacturer’s “cam cards,” cam catalogs and websites, is analyzed by the *Fitter* routines in the simulation to derive lobe and valve lift curves using a sinusoidal dynamics model that exactly passes through all 10 timing points.

Since both Dynomation6 and DynoSim6 use the *Fitter* algorithm “on-the-fly” to derive valve-lift curves from event timing, you are free to alter any timing point and instantly see how it affects engine performance. You can quickly change any valve event, lift, or advance/retard timing and test the effects on engine performance. When you have completed your testing, you can: **1)** Use the *CamManager™* to automatically search through a 10-Point camfile library to locate “real” camshafts with published data that closely matches your test timing, or you can **2)** Find cam-profile data sets that have *event timing* close to the discovered optimum. In both cases, using 10-Point cam timing facilitated finding best cam for your application.

The following several sections discuss how 10-Point cam files are loaded, tested, and manipulated in the *Camshaft Category* and in the *CamManager™*. Importing Lobe Profile Files is also discussed in detail. Even if you were planning on using Lobe Profile data almost exclusively, we suggest that you read the following sec-

CamDisk™ for Dynomation6, included on the Dynomation CD, includes over **6000, 10-Point CamFiles**. Using the **CamManager™** and the **Quick and ProLterator™**, Dynomation6 can automatically locate optimum profiles for virtually any application. Install the **CamDisk** library **AFTER** Dynomation6 has been installed on your computer.



Camshaft Category

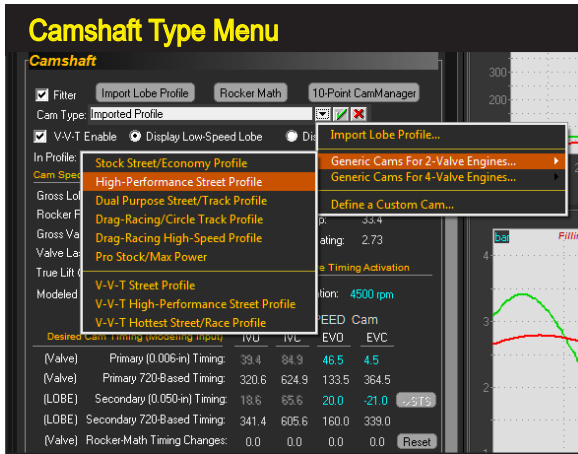

Several “generic” 10-Point cam data-sets are included in the *Cam Type* drop-down menu. They are separated into two groups, cams for 2-valve engines and cams for 4-valve engines. In addition, you can easily input any custom timing and valve-lift specifications.

tions on 10-Point timing. The information may help you improve your ability to test and locate optimum cam combinations for your test engine.

10-Point Generic Camshaft Menu Selections

The *Cam Type* menu in the *Camshaft* category contains 18 “generic,” camshafts (modeled using 10-Point timing data; see the previous section for an introduction to 10-Point cam timing) separated into two groups: Cams for 2-valve engines and cams for 4-valve engines. Since 2- and 4-valve applications can differ significantly in valve lift, and to some extent duration, the menu arrangement will help you quickly select a starting-point cam on which to base further testing.

When using any of these camshafts, the lift and timing data is loaded into the appropriate fields in the *Camshaft* category. In addition, the *Intake* and *Exhaust Centerlines*, the *Lobe Center Angle*, the *Intake* and *Exhaust Valve Duration*, *Valve Overlap* and other cam-related data is measured by the *Fitter* (after the simulation is has been completed) and displayed in the lower portion of the *Camshaft* category.

A general description of each cam in the *Cam Type* menu is provided in the next section.

2- And 4-Valve (Non-VVT) Cam Selections

2- And 4-Valve, Stock Street/Economy Cams

These first cam selections are OEM-replacement street cams for 2- and 4-valve engines. The lifter acceleration rate falls between 2.51 and 2.83 (on a 1.00-to-7.00 scale), which indicates that valve motion for these cams fall in the range of stock OEM to mild street performance applications. Rated valve lift is 0.510/0.510-inch for 2-valve engines and 0.305/0.305-inch for 4-valve engines (intake/exhaust).

Camshaft Category

The EVO timing maintains combustion pressure late into the power stroke and early IVC minimizes intake flow reversion. Late IVO and early EVC produce 38 degrees of overlap for 2-valve engines and 11-degrees for 4-valve engines, enough to harness some scavenging effects but limited enough to prevent severe exhaust gas reversion into the induction system. The characteristics of these cams are smooth idle, good power from 600- to 5000-rpm for 2-valve engines and typically between 1500- and 6500-rpm for 4-valve engines. These generic cams produce good fuel economy and work well in high-torque-demand applications.

2-Valve And 4-Valve High-Performance Street Cams

These profiles are designed to simulate high-performance “street” camshafts for 2- and 4-valve engines. These cams produce lifter acceleration rates between 3.10 and 3.32, indicating that valve motion falls in the range of a typical, mild, street-performance camshaft. Rated valve lift is 0.552 / 0.552-inch for 2-valve engines and 0.432 / 0.435-inch for 4-valve engines (intake/exhaust).

This camshaft uses relatively-late EVO to fully utilize combustion pressure and early IVC minimizes intake flow reversion (can be a serious problem on 4-valve engines, since low-lift flow can be substantial when both valves are open and expose large curtain areas). IVO and EVC produces between 54- and 60-degrees of overlap; profiles clearly intended to harness exhaust scavenging effects. The modestly-aggressive overlap allows some exhaust gas reversion into the induction system at lower engine speeds, affecting idle quality and low-speed torque. The characteristics of these cams are fair idle, good power from 1800- to 6000-rpm in 2-valve engines and between 2200- and 7500-

Non-V V T Cam Modeling

Camshaft

Import Lobe Profile Rocker Math CamManager

Cam Type: 2-Valve Drag-Racing/Circle Track

V-V-T Enable Display Low-Speed Lobe Display High-Speed Lobe

Cam Specification	Intake	Exhaust	Cam Specs	Intake	Exhaust
Gross Lobe Lift:	0.437 in	0.427 in	Centerline Angle:	106.0	106.0
Rocker Ratio:	1.50	1.50	True Centerline:	106.0	106.0
Gross Valve Lift:	0.656 in	0.640 in	Cam Adv(+)/Ret(-):	0.0	0.0
Valve Lash:	0.000 in	0.000 in	Lobe Centerline:	106.0	
Net (Sim) Valve Lift:	0.656 in	0.640 in	Valve Overlap:	91.0	
Published Duration:	298.0	308.0	Lifter Accel Rate:	4.50	Auto
W/A Lobe Data:	10-Point	10-Point	HS Lobe Activation:	4500 rpm	

Valve Events	IVO	IVC	EVO	EVC
Seat-to-Seat Event Timing:	43.0	75.0	80.0	48.0
720-Based Event Timing:	317.0	615.0	100.0	408.0
0.050-inch Event Timing:	27.0	59.0	61.0	29.0
True Timing (Adv/Ret and Rocker Ratio):	43.0	75.0	80.0	48.0

->STS

Cam timing events, lift, and more are displayed in the **Camshaft Category** on the Main Program Screen. Cam specifications shown in Light Blue can be changed with a mouse click. Since the engine being modeled in this photo uses a 10-Point cam model, all remaining cam specifications can be modified both in the **Camshaft Category** and in the **CamManager™**. Note this cam uses non-variable timing as shown by an unchecked **V-V-T Enable** box.

Camshaft Category

rpm in typical 4-valve engines. Good fuel economy is still a by-product of the relatively “mild” cam timing. Both *High Performance Street* cams can be used with higher acceleration rates (typically up to about 4.00) to model more aggressive profiles.

2-Valve And 4-Valve Dual Purpose Street/Track Cams

These profiles simulate high-performance aftermarket camshafts designed for street and mild track applications in 2- and 4-valve valve engines. These cams produce lifter acceleration rates of approximately 3.90, indicating that valve motion falls in the range of a high-performance street and mild racing. Rated valve lift is 0.608 / 0.614-inch for 2-valve engines and 0.472 / 0.457-inch for 4-valve engines (intake/exhaust).

EVO timing on this camshaft is beginning to move away from specs that would be expected for optimum combustion pressure utilization, with more of an emphasis on blowdown and minimizing exhaust-pumping losses. The later IVC attempts to strike a balance between harnessing the ram effects of the induction system while minimizing intake flow reversion. IVO and EVC produce 63- to 65-degrees of overlap, profiles designed to harness exhaust scavenging. The modestly aggressive overlap allows some exhaust gas reversion into the induction system at lower engine speeds, affecting idle quality and low-speed torque (can be a more substantial issue on 4-valve engines, since low-lift flow can be substantial when both valves are off their seats and expose large curtain areas). The characteristics of this cam are lopey idle, good power from 2500- to 6500-rpm in 2-valve engines and between 2500- and 7800-rpm in typical 4-valve engines. These cams develop considerable power at higher engine speeds and are especially effective in lightweight vehicles.

Drag-Racing, High-Speed Cam Modeling



All-out drag-racing cams for 2- and 4-valve engines are designed to optimize power on larger displacement engines at very high engine speeds with large-tube, open headers, and high compression ratios. These camshafts are often not effective in small displacement engines.

Camshaft Category

2-Valve And 4-Valve Drag-Race/Circle-Track (And Road-Racing) Cams

These profiles are designed to simulate competition, aftermarket camshafts for 2- and 4-valve engines. These cams produce lifter-acceleration rates of approximately 4.30, indicating that valve motion lies in the range normally used in competition-only engines. Expect somewhat reduced valvetrain life. Rated valve lift is 0.656 / 0.640-inch for 2-valve engines and 0.472 / 0.457-inch for 4-valve engines (intake/exhaust).

EVO timing places less emphasis on utilizing combustion pressure and more emphasis on beginning early blowdown to minimize exhaust-pumping losses. The later IVC attempts to strike a balance between harnessing the ram effects of the induction system while minimizing intake flow reversion. IVO and EVC produce 91-degrees of overlap (60-degrees for 4-valve engines) to harness exhaust scavenging. This aggressive overlap is designed for higher engine speeds with open headers and allows exhaust gas reversion into the induction system at lower rpm, affecting idle quality and torque below 3000- to 4000-rpm. The characteristics of these cams are very lopey idle, good power from 6600 to 8600rpm in 2-valve engines and between 3000- and 8000-rpm in typical 4-valve engines, with little consideration for fuel economy. These cams develop substantial power at higher engine speeds and are especially effective in lightweight vehicles.

2-Valve And 4-Valve Drag-Race/High-Speed Cams

These cam profiles simulate aftermarket high-performance competition camshafts for 2- and 4-valve engines. These cams produce lifter-acceleration rates between 3.94 to 4.60, valve motion that falls in the range normally used in competition-only engines. These camshaft produce good power while sacrificing some valvetrain life (especially considering the 2-valve cam acceleration

2-Valve ProStock Camshafts



Optimizing power on very-large displacement engines at high engine speeds and with high compression ratios, requires EVO timing that focuses on early blowdown to minimize pumping losses. Late IVC helps harness the full ram effects of the induction system while relying on intake pressure wave tuning to minimize intake-flow reversion.

Camshaft Category

rates of 4.60). Rated valve lift is 0.692 / 0.692-inch for 2-valve engines and 0.488 / 0.472-inch for 4-valve engines (intake/exhaust).

All timing events on this camshaft are designed to optimize power on larger displacement engines at very high engine speeds with large-tube, open headers, and high compression ratios. This camshaft may not be effective in small displacement engines. EVO timing places the utilization of combustion pressure on the “back burner” and focuses emphasis on beginning early blowdown to minimize pumping losses during the exhaust stroke. This technique will help power at very high engine speeds, especially on 2-valve, large-displacement engines that do not easily discharge the high volume of exhaust gasses they produce. The late IVC attempts to harness the full ram effects of the induction system while relying on intake pressure wave tuning to minimize intake-flow reversion. IVO and EVC produce 104-degrees of overlap (71-degrees for 4-valve engines), a profile that is clearly intended to utilize exhaust scavenging effects. This very aggressive overlap seriously affects idle quality and torque below 4500rpm. A 5000rpm stall torque converter is recommended for automatic transmission applications. The characteristics of this cam are extremely lopey idle, good power from 4500 to 7200rpm in 2-valve engines and between 5000- and 9500-rpm in typical 4-valve engines, with no consideration for fuel consumption.

2-Valve ProStock/Max-Power Cam (modeled after CompCams 11-728-9)

This profile is designed to simulate an all-out, maximum-power competition camshaft for 2-valve engines (because of the inherent better breathing in a 4-valve design, a cam of this design—an all-out attempt to generate maximum blowdown at the very highest speeds—is not necessary). This cam uses roller-solid lifters and produces an acceleration rate of 5.40, indicating that valve motion falls in the high range normally used in competition-only engines. Valvetrain loads will be substantial, and frequent replacement of valvesprings and other components may be required. Rated valve lift is 0.867-inch for the intake and 0.816-inch for the exhaust.

This ProStock cam is designed for one thing: maximum power at all costs. It is designed to optimize power on very-large displacement engines at very high engine speeds with large-tube, open headers, and very-high compression ratios. EVO timing focuses on beginning early blowdown to minimize pumping losses, a technique that helps large-displacement engines discharge the high volume of exhaust gasses they produce. Late IVC attempts to harness the full ram effects of the induction system while relying on intake pressure wave tuning to minimize intake-flow reversion. IVO and EVC produce 110 degrees of overlap. This very aggressive overlap basically has no idle quality or torque below 6000rpm. The characteristics of this cam are extremely lopey idle, and awesome power potential from 7000 to 9000rpm.

2- And 4-Valve Variable-Valve-Timing (V-V-T)

Camshaft Category

V-V-T (VTEC) Camshaft Modeling

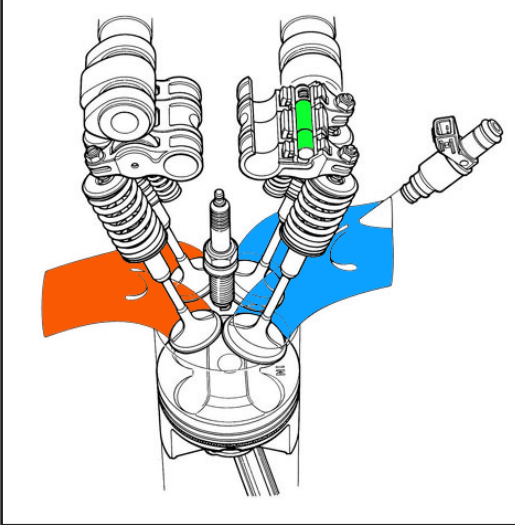

You can model variable valve timing (V-V-T) as used by Honda (in their VTEC system) and engines with similar valvetrain designs. This mechanism uses a discrete low-speed profile, and then at a particular engine speed switches to a high-speed cam profile. Honda uses a simple pin (shown in green) driven with oil pressure (timed with an electronic controller) that locks the outer two low-speed rockers (actuating the valves) to the center rocker that rides on the high-speed lobe. This allows the engine to maintain excellent driveability and fuel economy at low speeds, yet produce power similar to a “race” engine at higher speeds.

Cam Modeling

There have been two major engineering “enhancements” incorporated in modern automobile engines that have contributed to new levels of performance and the potential for even more. Getting more air and fuel in the engine has always been the bottom-line for performance, and 4-valve cylinderheads accomplish that goal with

Variable Valve Timing, like the VTEC system used on this B16 (1600cc) Honda engine, lets the engine build optimum power yet obtain good driveability and fuel economy (and much lower emissions) at lower engine speeds.

V-V-T Best Of Both Worlds



Camshaft Category

Porsche Boxter VarioCam™

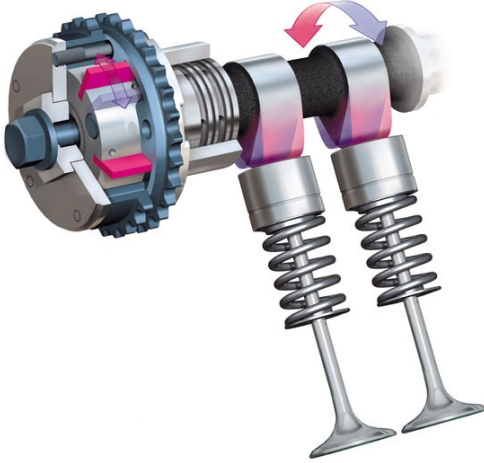

The Porsche Boxter uses variable valve timing technology called VarioCam™. It alters the timing on the intake valves based on engine speed and load. As well as enhancing power and torque, the system offers smoother performance, improved fuel economy and lower emissions.

aplomb. While certainly not a “new” invention, 4-valve cylinder heads have become commonplace in showroom floors. But that’s not the whole picture, for it’s the combination of better breathing cylinder heads and Variable-Valve-Timing schemes that have brought power levels to such heights. These technologies have allowed the auto manufacturers to build a “one-two punch” into modern engines: 1) High flow potential with “aggressive,” high-speed cam profiles combined with low-restriction ports and valves, and 2) Maintain low emissions and excellent low-rpm power with mild, low-speed cam timing. Variable valve timing lets car manufacturers have what they need—a “mild” engine that meets emissions and driveability requirements—while giving performance enthusiasts what they want—no-compromise valve timing and optimum power.

The Variable-Valve-Timing (V-V-T) model in the simulation functions like the basic cam-control system used on many Honda automobile engines (called *VTEC™*, for *Variable Timing Electronic Control*). At low speeds, the engine operates on *Low-Speed Lobe* profiles designed to minimize emissions and optimize driveability. Then, at some higher engine speed (usually between 4000 to 6000rpm), the valvetrain “switches over” to *High-Speed Lobe* profiles that, primarily, are designed for performance. Without the V-V-T system, Honda and other car manufacturers wouldn’t even consider using a cam with the timing specs of the high-speed lobes, since the engine would barely idle, have poor low-speed throttle response and torque, and generate plenty of unwanted emissions. But when that same cam is limited to high-rpm, wide-open-throttle use, power and driveability coexist.

Note-1: With more sophisticated electronic valvetrain systems, the timing of individual intake valves is staggered at low rpm and their lift is asymmetric, which creates charge swirl within the combustion chambers, reducing emis-

Camshaft Category

sions and improving fuel economy. At higher rpm, when more performance is desired—but before the valvetrain transitions to the High-Speed Lobes—both valves open in unison. Finally, at still higher speeds, the variable-valve-timing computer switches, as described previously, into high-lift, long-duration cam profile program.

Note-2: There are many variations of variable cam timing technologies. The most advanced of these designs can provide virtually “ideal” timing for every driving situation, from idle through full-throttle performance and every step in between.

Whenever you select any of the V-V-T cams from the *Cam Type* menu, V-V-T modeling will be activated, as indicated by a checkmark in the box next to **V-V-T Enable** in the **CAMSHAFT** category. Also, when V-V-T is activated, the box next to the **Variable Valve Timing** field in the *10-Point CamManager™* (discussed later in this chapter) will display a checkmark.

4-Valve V-V-T Mild Street Cam

This profile is designed to simulate conservative OEM camshafts that are used in some 4-valve, V-V-T engines. This cam uses direct-rocker valve actuation (Overhead Cam) and produces an acceleration rate of 2.55 for the Low-Speed Lobe and 2.85 for the High-Speed Lobe, indicating that valve acceleration for these profiles fall well within the range of stock to mild-performance rates. Rated valve lift is 0.325-inch (8.25mm) on the Low-Speed Lobes and 0.420 / 0.416-inch (10.67 / 10.57mm) for the intake and exhaust on the High-Speed Lobes.

This camshaft uses very mild cam timing on the low-speed lobes, with only 15-degrees overlap. This profile is designed, primarily, to minimize emissions and maximize fuel economy up to the activation rpm of the high-speed lobes (typically 5000-to-5500rpm). The high speed lobe is of moderate performance design, with 30% more lift and a 6% increase in valve durations. Valve overlap is increased to 25-degrees, so exhaust scavenging effects will be minimal.

The overall characteristics of this cam are smooth idle, good power from 1000 to 7500rpm, and good part-throttle fuel economy.

2- And 4-Valve V-V-T Performance Street Cams

These profiles are designed to simulate mild-performance street camshafts commonly for 2- and 4-valve, V-V-T (VTEC) engines. These cams produce an acceleration rate of 2.83 to 2.41 for the Low-Speed Lobes about 3.15 for the High-Speed Lobes, indicating that valve acceleration for these profiles fall in the range of mild to performance rates. Rated valve lift is 0.510 (2-valve) / 0.335-inch (4-valve) on the Low-Speed Lobes and 0.552 (2-valve) / 0.459 & 0.416-inch (4-valve, intake/exhaust) for the High-Speed Lobes.

This camshaft uses mild cam timing on the low-speed lobes, with only 38-degrees overlap (2-valve cams) and 11-degrees (4-valve cams). These profiles

Camshaft Category

are designed, primarily, to reduce emissions and optimize fuel economy up to the activation rpm of the high-speed lobes (typically 5000-to-5500rpm). The high speed lobe is of moderate performance design. Valve overlap is increased to 60-degrees (2-valve) and 46-degrees (4-valve), a sufficient amount to begin harnessing some exhaust scavenging effects. If the high-speed lobe was used below about 4000rpm, the modestly-aggressive overlap would allow exhaust-gas reversion into the induction system at lower engine speeds, affecting idle quality and low-speed torque. The overall characteristics of this cam are smooth idle, good power from 1000 to 7500rpm, and good part-throttle fuel economy.

2- And 4-Valve V-V-T High-Performance Street Cams

These profiles are designed to simulate high-performance street camshafts for 2- and 4-valve, V-V-T (VTEC) engines. These cams produce acceleration rates of 2.93 to 3.12 for the Low-Speed Lobes and 3.84 to 3.93 for the High-Speed Lobes, indicating that valve acceleration for this profile falls in the range commonly used for high-performance applications. Rated valve lift is 0.552 (2-valve) / 0.354-inch (4-valve) on the Low-Speed Lobes and 0.608 & 0.614-inch (2-valve, intake/exhaust) / 0.472 & 0.457-inch (4-valve, intake/exhaust) for the High-Speed Lobes.

These camshafts use somewhat more aggressive cam timing on the low-speed lobes, with 60-degrees of overlap (2-valve cams) and 29-degrees (4-valve cams). These profiles will begin to harness exhaust scavenging effects even while running the low-speed cam timing. The increased overlap allows some exhaust gas reversion into the induction system at lower engine speeds, slightly affecting idle quality and low-speed torque. The high speed lobes are designed for performance, with 20% to 33% more lift and a 10% to 18% increase in valve durations. Valve overlap is increased to 63-degrees (2-valve cams) and 65-degrees (4-valve cams), modestly-aggressive values that take advantage

VANOS™ BMW Technology

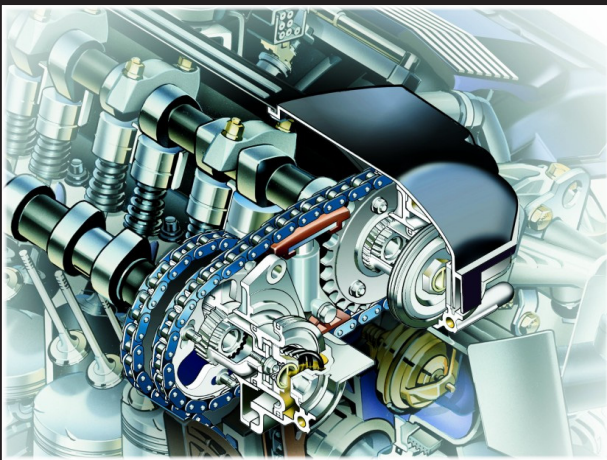

Variable Valve Timing has become a “standard” on most engines. This Double-VANOS system, used on the BMW M3, changes the relationship between cams (alters the cam-centerline angle) to modify valve overlap as engine rpm and engine load change.

Camshaft Category

Activating V-V-T And Displaying High-Speed Lobe

Camshaft

Filter

Cam Type: **V-V-T Street Cam**

V-V-T Enable Display Low-Speed Lobe Display High-Speed Lobe

In Profile: None Ex Profile: None

Cam Specification	Intake	Exhaust	Additional Cam Specifications
Gross Lobe Lift:	0.306 in	0.277 in	Lobe CL (Int to Exh): 107.5
Rocker Ratio:	1.50	1.50	Valve Overlap: 39.0
Gross Valve Lift:	0.459 in	0.416 in	Cam Accel Rating: 4.37
Valve Lash:	0.020 in	0.020 in	
True Lift @ Valve:	0.439 in	0.396 in	
Modeled From:	10-Point	10-Point	V-V-T Activation: 4500 rpm

Variable Valve Timing Activation

Desired Cam Timing (Modeling Input)	V-V-T HIGH SPEED Cam			
	IVD	IVC	EVO	EVC
(Valve) Primary (0.006-in) Timing:	26.0	60.0	56.0	20.0
(Valve) Primary 720-Based Timing:	334.0	600.0	124.0	380.0
(LOBE) Secondary (0.050-in) Timing:	12.5	46.5	42.5	6.5
(LOBE) Secondary 720-Based Timing:	347.5	586.5	137.5	366.5
(Valve) Rocker-Math Timing Changes:	0.0	0.0	0.0	0.0
(LOBE) Centerline (Max Lift to TDC):	106.5		108.5	

When any of the V-V-T cams have been selected or a V-V-T CamFile has been loaded in the CamManager™, V-V-T modeling will be activated, indicated by a checkmark in the **V-V-T Enable** box in the **CAMSHAFT** category and in the **Variable Valve Timing** box in the CamManager™. To display High-Speed lobe timing, click the **Display High-Speed Lobe** radio button.

of free-flowing headers and mufflers (recommended for this cam). The narrow lobe centerline angle of 102-degrees on the 4-valve cam applications should be widened (with adjustable cam sprockets on dual-overhead cam engines) for turbocharged applications and even on some naturally-aspirated engines with low exhaust restriction. The overall characteristics of this cam are a slightly rough idle, good power from 2500 to 8500rpm, and moderate -to-good part-throttle fuel economy.

2- And 4-Valve Max Street/Race Cams

These profiles are designed to simulate maximum performance street camshafts for 2- and 4-valve, V-V-T (VTEC) engines. These cams produce acceleration rates of 2.69 to 3.12 for the Low-Speed Lobes and 4.09 to 4.27 for the High-Speed Lobes, indicating that valve acceleration for this profile falls in the range for high-performance applications. Rated valve lift is 0.552 (2-valve) / 0.380 & 0.370-inch (4-valve, intake/exhaust) on the Low-Speed Lobes and 0.656 & 0.640-inch (2-valve, intake/exhaust) / 0.500 & 0.480-inch (4-valve, intake/exhaust) for the High-Speed Lobes.

These low-speed lobe profiles for 2-valve engines are the same as the previous *High-Performance Street Cam*. The 4-valve camshaft uses relatively mild cam timing on the low-speed lobes, with only 16-degrees overlap. This profile is designed to maintain a good idle and torque at low engine speeds. The high speed lobes are a high-performance design, with an 18% to 31% more lift and 9% to 20% increase in valve durations. Valve overlap is increased to an aggressive 91-degrees (2-valve cams) and 76-degrees (4-valve cams) that takes advantage of free-flowing headers and mufflers (headers, while not required, will significantly improve performance with this cam). The lobe cen-

Camshaft Category

terline angle (106- to 109-degrees) of the high-speed lobes can be widened somewhat (with adjustable cam sprockets) for turbocharged applications and even on naturally-aspirated engines with very low exhaust restriction. The overall characteristics of this cam are good to slightly-rough idle and excellent power from 1500 to 9000rpm, with good to moderate part-throttle fuel economy.

Note: Each of the previous application-specific cams can be modified by directly entering custom valve-event timing or other cam specifications.

Variable Valve Timing (V-V-T) Activation And Custom V-V-T Modeling

When you select a V-V-T cam from the **Cam Type** menu in the **CAMSHAFT** category, or you import/load a V-V-T cam, *Variable Valve Timing* modeling will be activated, however, you can activate or deactivate *Variable Valve Timing* at any time. When activated, *Low-Speed Lobe* timing will be used in the simulation until the engine reaches the *HS Lobe Activation* rpm, after which *High-Speed Lobe* timing will be used.

Note: When V-V-T is deactivated, by un-checking the **V-V-T Enable** checkbox, only “*Low-Speed Lobe*” timing will be used in the simulation.

You can also create a V-V-T cam from “scratch” to meet any requirement. For example, if you have found a non-V-V-T camshaft that produces good low-speed performance and another cam that produces good high-speed power, you can “combine” the two cams in the simulation. Here’s how: First, import or directly enter the cam timing for the low-speed lobe. When low-speed data has been entered (and all other engine component specs have been entered), a simulation will be performed. Next, activate V-V-T camshaft modeling (by clicking the **V-V-T Enable** checkbox). The *Camshaft* Category indicator may switch to **RED**, indicating that the category is no longer complete. Now, click on the **Display High-Speed Lobe** radio button and enter the cam timing for the High-Speed Lobe. When complete, the simulation will model the original Low-Speed camshaft up to the **HS Lobe Activation** speed, after which High-Speed timing will be used.

Lobe-Lift, Rocker-Ratio, Valve-Lash And Net Valve Lift

The *Intake* and *Exhaust True Lift @ Valve* fields display the maximum lift (at the valves) for the currently-selected camshaft, regardless of whether the cam was chosen from the *Cam Type* menu, loaded as a Cam Profile, manually entered as valve-event specs, or loaded from a CamFile using the *10-Point CamManager™*.

The values displayed in the **True Lift @ Valve** fields are mathematically linked with the current *Lash* values and the *Rocker Ratios*. Normally, the *True Lift @ Valve* values are computed from data in the fields directly above: **Gross Lobe Lift**, **Rocker Ratio**, and **Valve Lash**. The calculation begins at **Gross Lobe Lift**. This

Camshaft Category

True Valve Lift Menu

Filter Import Lobe Profile Rocker Math 10-Point CamManager
 Cam Type: V-V-T Street Cam
 V-V-T Enable Display Low-Speed Lobe Display High-Speed Lobe
 In Profile: None Ex Profile: None

Cam Specification	Intake	Exhaust	Additional Cam Specifications
Gross Lobe Lift:	0.306 in	0.277 in	Lobe CL (Int to Exh): 107.5
Rocker Ratio:	1.50	1.50	Valve Overlap: 39.0
Gross Valve Lift:	0.459 in	0.416 in	Cam Accel Rating: 4.37
Valve Lash:	0.020 in	0.020 in	
True Lift @ Valve:	0.439 in	0.396 in	<input checked="" type="checkbox"/> Variable Valve Timing Activation
Modeled From:	10-Point	10-Point	

Desired Cam Timing (Modeling Input)
 (Valve) Primary (0.006-in) Timing: 0.300 Inches / 7.62 mm Lift
 (Valve) Primary 720-Based Timing (LOBE) Secondary (0.050-in) Timing: 0.450 Inches / 11.43 mm Lift
 (Valve) Primary 720-Based Timing (LOBE) Secondary 720-Based Timing: 0.500 Inches / 12.70 mm Lift
 (Valve) Rocker-Math Timing Change: 0.550 Inches / 13.97 mm Lift
 (LOBE) Centerline (Max Lift to TDC): 0.600 Inches / 15.24 mm Lift
 (LOBE) Cam Advance(+)/Retard: 0.650 Inches / 16.51 mm Lift
 True Cam Timing (Measured Value): 0.700 Inches / 17.78 mm Lift
 Auto Calculate Valve Lift: 0.750 Inches / 19.05 mm Lift
 0.800 Inches / 20.32 mm Lift

Use the **True Lift** data field to quickly enter after-lash and after-rocker-ratio maximum valve lift values for the intake and/or exhaust valves. Note: If you perform an entry in this field, the Gross Lash will be re-calculated to maintain the mathematical relationships between the lift, lash, and ratio fields. Use **Auto Calculate Valve Lift** to have the simulation automatically calculate BOTH intake and exhaust valve-lift values when valve lift data is unknown (see the text for more information on using “auto calc” features in the simulation).

value is multiplied by the **Rocker Ratio** and the result is displayed in the **Gross Valve Lift** field. This value is then reduced by the **Valve Lash** to yield the final **True Lift @ Valve** for both the intake and exhaust valves. The simulation maintains this mathematical relationship. If you change the **Lash**, the **True Lift** will be recalculated. In fact, if you change the **True Lift** directly, the program will assume that the **Gross Lobe Lift** must have changed, and it will recalculate that value to keep the mathematical relationship “in sync.”

Rocker-Ratio, Lash, And The Rocker-Math Calculator: DO NOT use the Rocker-Math Calculator (discussed in more detail later in this chapter) to enter the cam manufacturer’s specifications for Rocker Ratio and Valve Lash. Always

The simulation maintains the mathematical relationship between all the Lift fields in the Camshaft Category. If you change the **Lash**, the **True Lift** will be recalculated. If you change the final **True Lift**, the program will assume that the **Gross Lobe Lift** was changed and it will recalculate that value to keep the mathematical relationships “in sync.”

Valve Lift, Lash, And Rocker Ratio

Camshaft

Filter Import Lobe Profile Rocker Math 10-Point CamManager
 Cam Type: V-V-T Street Cam
 V-V-T Enable Display Low-Speed Lobe Display High-Speed Lobe
 In Profile: None Ex Profile: None

Cam Specification	Intake	Exhaust	Additional Cam Specifications
Gross Lobe Lift:	0.306 in	0.277 in	Lobe CL (Int to Exh): 107.5
Rocker Ratio:	1.50	1.50	Valve Overlap: 39.0
Gross Valve Lift:	0.459 in	0.416 in	Cam Accel Rating: 4.37
Valve Lash:	0.020 in	0.020 in	
True Lift @ Valve:	0.439 in	0.396 in	
Modeled From:	10-Point	10-Point	

V-V-T HIGH SPEED Cam
 IVO IVC EVO EVC
 (Valve) Primary (0.006-in) Timing: 26.0 60.0 56.0 20.0
 (Valve) Primary 720-Based Timing: 334.0 600.0 124.0 380.0
 (LOBE) Secondary (0.050-in) Timing: 12.5 46.5 42.5 6.5

Camshaft Category

enter these specs in the Camshaft Category directly. Then, after the recommended specifications have been entered, *use the Rocker Math Calculator to determine how CHANGES to these stock specifications will affect cam timing, valve lift, and simulation results.* For more information on using the *Rocker-Math Calculator*, see the chapter *Version-6 Built-In Calculators*).

Using the Net (Sim) True Valve-Lift Menu

As mentioned previously, the *Direct-Click™* menus for the **True Lift @ Valve** fields allow you to quickly change the maximum valve lift, useful in those cases where you wish to perform “free-form” testing of lift vs. engine output. If you have imported a specific cam, be aware that the original Gross Lift values from your CamFile will be overwritten to maintain the mathematical relationship between the newly entered Net Lift and the existing Rocker Ratio and valve Lash. The **True Lift @ Valve** menus are intended for those times when you aren’t concerned about maintaining existing cam specs; you simply wish to enter a specific lift without concern for rocker ratio, lash, or other considerations.

This also applies to the **Auto Calculate Valve Lift** option at the bottom of the **True Lift @ Valve** menu. This function (see photo, below) is useful when you want to use an appropriate valve-lift based on the current valve diameters. When **Auto Calculate** is enabled, the simulation will automatically calculate the lift for BOTH intake and exhaust valves (*Gross Lobe Lift* may be recalculated to maintain the mathematical relationships with the *Rocker Ratio*, and *Valve Lash*. The *Auto-Calculation* feature can be turned off by re-selecting *Auto Calculate Valve Lifts* (“A” indicator and the checkmark in the menu will be removed).

Note 1: Auto Calculate Valve Lifts *is turned off by default when any CamFile is loaded, since each CamFile represents a “real-world” cam that has specific valve-lift values associated with it.* However, you can reactivate *Auto-Calculation* at any time by selecting it from the menus.

Note 2: If Valve Diameters are also being automatically calculated in the Cyl-

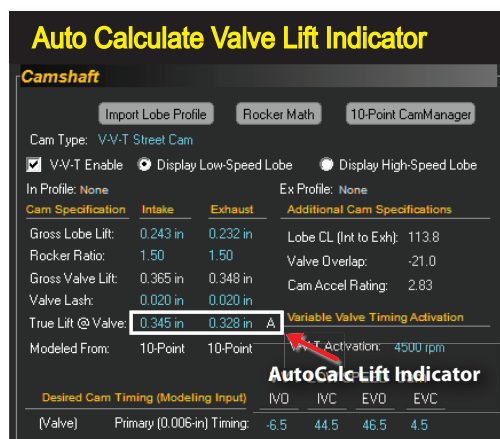

When **Auto Calculate Valve Lift** is enabled, the simulation will automatically calculate BOTH intake and exhaust valve-lift values. The *Auto-Calculation* feature displays an “A” next to the calculated valve lift values when it is activated. Selecting **Auto Calculate** from the menu, instructs the simulation to automatically calculate appropriate valve lifts values for both the intake and exhaust valves. This is useful to quickly estimate typical cam manufacturer’s valve lift for the selected cam timing and application.

Camshaft Category

Follow a simple rule when using Rocker Math: **Enter the original cam manufacturer's specifications for Rocker Ratio in the Camshaft Category FIRST!** Then use the Rocker Math Calculator to determine how **CHANGES** to these stock specifications affect cam timing, valve lift, and engine power.

Rocker-Math Calculator

IMPORTANT: First enter recommended Rocker Ratios in the Camshaft Category, then use this calculator to modify Rocker Ratios and determine the effects on valve lift and duration.

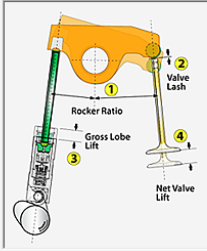

	Intake	Exhaust
Original Rocker Ratio:	1.50	1.50
New Rocker Ratio:	<input type="text" value="1.75"/>	<input type="text" value="1.60"/>
Valve Lash (in)*:	0.015	0.020
Gross Lobe Lift:	0.582 in	0.566 in
Valve Lift W/Org Ratio:	0.858 in	0.828 in
New Net Valve Lift:	<input type="text" value="1.003 in"/>	<input type="text" value="0.885 in"/>

* NOTE: Apply lash changes in the CamShaft Category. Lash timing changes are incorporated in True Timing.

Effects On Valve Timing (Seat-To-Seat)

Original Rocker-Ratio and Valve-Lash							
54.0	84.0	305.0	102.0	52.0	315.0	5.24	
I/O	I/V	Original Duration	EVO	EVC	Original Duration	Acceleration Rate	

inder Head component category—cylinder-bore diameter and a cylinder-head selection must be made before the program can complete the calculation of valve diameters and, consequently, valve lifts.

An Introduction To The Rocker-Math Calculator

The Camshaft Category includes a **Rocker-Math Calculator** that will help you analyze how and why changes in rocker ratio affect engine output. To use the Calculator appropriately, follow this simple rule: *Enter original cam manufacturer's specifications for Rocker Ratio in the Camshaft Category **FIRST!** Then use the Rocker Math Calculator to determine how **CHANGES** to these specifications will affect cam timing, valve lift, and engine power.* For more information on using the **Rocker-Math Calculator**, see the chapter *Version-6 Built-In Calculators* later in this manual.

Lifter/Valve Acceleration Rates

The simulation performs an analysis of the valve motion generated by cam lobe profiles and displays an overall valvetrain acceleration rate. The acceleration values are calculated from an analysis of intake and exhaust opening and closing ramps, flank and nose radii, all timing specifications, and maximum lift data. The values (from 1.0 to 9.0+), displayed in the **Additional Cam Specs** group in the **Camshaft Category**. *Individual* intake and exhaust valve acceleration rates are displayed in the **Measured Values** group.

The range of acceleration values form a relative scale that offers 900-steps of granularity. The values include acceleration rates used in modern production/street cams (with values ranging from 1 to 3) to racing-only applications (with values

Camshaft Category

Valve Motion Curves & Acceleration

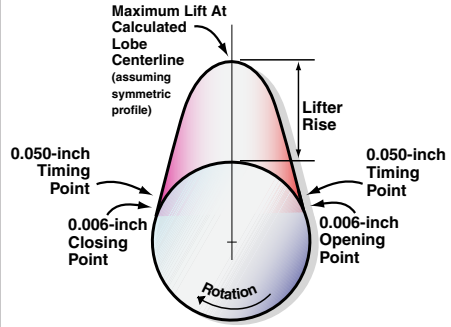

10-Point Lifter Acceleration Is Derived From Seat-To-Seat and 0.050-Inch Opening and Closing Points, And The Maximum Lift Of Each Lobe

The simulation calculates valve acceleration rates based on current valve timing specifications. Valvetrain acceleration values range from 1.00 (very-low acceleration) to 9.00+ (extremely-high acceleration). This data is provided for any Lobe Profile or any 10-Point cam model.

from 4 or 5 to as high as 6 to 8+). Using this simple designation, you can quickly determine the general operating characteristics of any camshaft.

Use the following guidelines to evaluate *Acceleration Rates*:

- 1.00 Very Low Acceleration
- 2.00 Stock Production, OEM Camshafts, Long Valvetrain Life
- 3.00 Performance OEM and Aftermarket Performance, Good Life
- 4.00 Mild Racing & Performance, Limited Street Application

Lifter/Valve Acceleration Display

Cam Specification	Intake	Exhaust	Additional Cam Specifications
Gross Lobe Lift:	0.313 in	0.260 in	Lobe CL (Int to Exh): 107.5
Rocker Ratio:	1.50	1.50	Valve Overlap: 31.0
Gross Valve Lift:	0.470 in	0.390 in	Cam Accel Rating: 3.19
Valve Lash:	0.020 in	0.020 in	Variable Valve Timing Activation
True Lift @ Valve:	0.450 in	0.370 in	V-V-T Activation: 4500 rpm
Modeled From:	10-Point	10-Point	

Cam & Valve Acceleration Rates

Desired Cam Timing (Modeling Input)	IVO	IVC	EVO	EVC
(Valve) Primary (0.006-in) Timing:	26.0	60.0	56.0	20.0
(Valve) Primary 720-Based Timing:	334.0	700.0	124.0	380.0
(LOBE) Secondary (0.050-in) Timing:	5.0	4.0	38.0	2.0
(LOBE) Secondary 720-Based Timing:	355.0	580.0	142.0	362.0
(Valve) Rocker-Math Timing Changes:	0.0	0.0	0.0	0.0
(LOBE) Centerline (Max Lift to TDC):	107.0		108.0	
(LOBE) Cam Advance(+)/Retard(-):	0.0		0.0	
True Cam Timing (Measured Values)	IVO	IVC	EVO	EVC
(Valve) Timing @ 0.006-in Valve Lift:	17.0	51.0	50.0	14.0
(LOBE) Timing @ 0.050-in Lobe Lift:	5.0	4.0	38.0	2.0
(LOBE) Camshaft Ramp Dynamics:	■	■	■	■
(Valve) Acceleration Rates:	3.23		3.16	
(Valve) Centerline Angle (Weighted):	107.0		108.0	

The simulation automatically calculates values that represent the *Overall Cam Acceleration* and individual *Valve Acceleration Rates* by performing an analysis of valve timing and lobe dimensional specifications. The Intake and Exhaust Valve Acceleration values are displayed in the *Measured Values* group. The overall *Cam Acceleration Rate* is shown in the *Additional Cam Specifications* fields. The acceleration rates vary from 1.0 to as high as 9.0+ (see the text for more information on these values).

Camshaft Category

- 5.00 Racing, Valvetrain Loads Require Use Of Optimum Components
- 6.00 Racing, Reduced Valvetrain Life With Best Components
- 7.00 High Valvetrain Loads, Requires Regular Valvetrain Maintenance
- 8.00+ Extreme Acceleration And Loads, Very Limited Valvetrain Life

If you wish to evaluate *changes* in valve acceleration, you must alter the shape of the lobes; defined, in part, by the location of Seat-to-Seat and 0.050-inch timing points and the maximum lift of the lobes. Moving 0.050-timing closer to Seat-To-Seat (and/or increasing lift) will mathematically reshape the lobe and increase the acceleration (this requires 10-point cam timing as described earlier). Moving 0.050-timing farther from Seat-To-Seat values will decrease acceleration. All modified timing values are analyzed for stability by the **Fitter** algorithms in the simulation. Values that generate lobe shapes that cannot be properly modeled will trigger one of the **Valvetrain Dynamics Indicators** in the Camshaft Category to switch from green to yellow or red.

Note-1: Select **Show Simulation Log** from the Simulation Menu at the top of the program screen to obtain additional information about any displayed yellow or red valvetrain indicators.

Note-2: In Dynomation-5 & DynoSim5, the acceleration rate could be directly modified. Now, cam/valve timing points directly control the acceleration values for both the intake and exhaust valves. You can still modify the acceleration rates, however, it requires changing valve timing, rocker ratios, and/or maximum lift values.

The simulation analyzes valvetrain dynamics for any 10-point cam used in the simulation. If the **Fitter** algorithms cannot generate a stable sinusoidal curve that passes through the opening, closing and max-lift points, one or more of the Dynamics Indicators in the Camshaft Category will switch from green to yellow or red (depending on the severity of the mismatch).

Ramp Dynamics Indicators

Desired Cam Timing (Modeling Input)		IVD	IVC	EVD	EVC
(Valve)	Primary (0.006-in) Timing:	54.0	84.0	102.0	52.0
(Valve)	Primary 720-Based Timing:	306.0	624.0	78.0	412.0
(LOBE)	Secondary (0.050-in) Timing:	37.5	67.5	93.0	44.0
(LOBE)	Secondary 720-Based Timing:	322.5	607.5	87.0	404.0
(Valve)	Rocker-Math Timing Changes:	0.0	0.0	0.0	0.0
(LOBE)	Centerline (Max Lift to TDC):	105.0		115.0	
(LOBE)	Cam Advance(+)/Retard(-):				

Valvetrain Indicators

True Cam Timing (Measured Values)		IVD	IVC	EVD	EVC
(Valve)	Timing @ 0.006-in Valve Lift:	54.0	84.0	102.0	52.0
(LOBE)	Timing @ 0.050-in Lobe Lift:	37.5	67.5	93.0	44.0
(LOBE)	Camshaft Ramp Dynamics:	■	■	■	■
(Valve)	Acceleration Rates:	6.79		10.77	
(Valve)	Centerline Angle (Weighted):	105.0		115.0	

Other True Timing Measurements

(Valve)	Duration @ 0.006-in Valve Lift:	318.0	334.0
(LOBE)	Duration @ 0.050-in Lobe Lift:	285.0	317.0
(Valve)	Duration @ 0.050-in Valve Lift:	293.0	323.0
(Valve)	Timing @ 0.050-in Valve Lift:	42.0	71.0
(Valve)	Timing @ 0.050-in Valve Lift:	96.0	47.0

Camshaft Category

Note-3: The valvetrain acceleration rates for 4-valve engines often are not as high as those for 2-valve engines designed for similar applications. 4-valve engines benefit from higher low-lift flow (due to the increased curtain area exposed as both valves open), and consequently, cams for these engines do not normally accelerate the valves as rapidly off of the seats.

Camshaft Category—The CamManager™

The 10-Point Cam Manager™

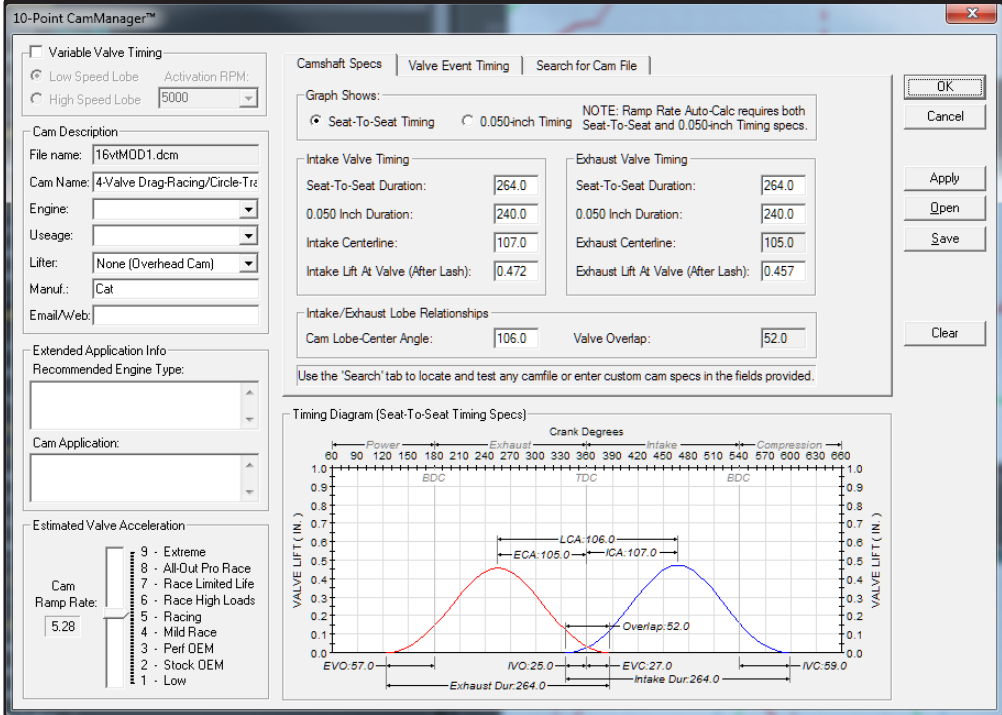

The *10-Point CamManager™* is a cam manipulation tool for 10-Point cam specs built into the simulation. It offers complete control and visualization of all 10-Point timing and lift values. Use it to enter and modify any cam-related information and search for “real-world” camshafts from your cam libraries that matches any desired range of timing values.

Using The *10-Point CamManager™* Applies To FE and WA Simulations, Except as Indicated

The *CamManager™* is a comprehensive tool built into the simulation that will help you display, test, modify, and even search your cam libraries for optimum 10-Point cam modeling data for any engine application.

Note About Lobe Profile Files: When a *Lobe Profile* file is loaded into the simulation, the *CamManager* is no longer directly accessible. If you attempt to open the *CamManager*, a dialog will let you know that if you proceed, all Profile data used by the current simulation will be converted to 10-Point timing data. The reason for this is that the *CamManager* is specifically designed as a 10-Point valve-event manipulation tool. Since individual valve-events cannot be changed when Lobe Profile files are used (only centerlines, cam advance and retard, rocker ratio, and lash can be altered; these specifications can all be modified directly from within the **Camshaft** Component category) the *CamManager* features are not available when Lobe Profile data is used in

Camshaft Category—The CamManager™

The CamManager™ Features And Functional Groups

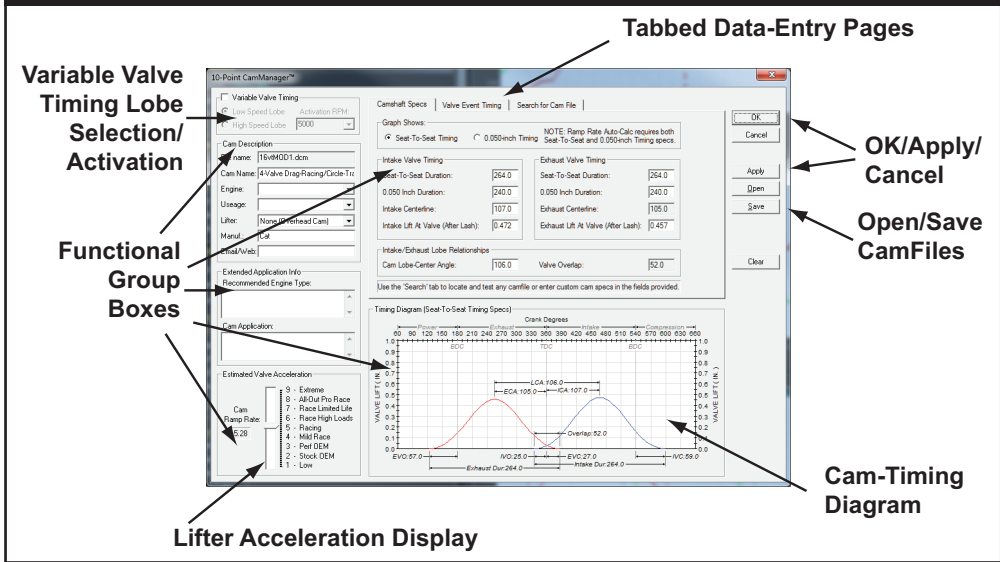

The *CamManager*™ incorporates a wide range of functionality and tools that are intuitive and easy-to-use. To this end, the *CamManager* is divided into functional groups that separate basic functionality into several “boxes” (see text for more information).

the simulation.

The *CamManager* has many features and capabilities. To make this comprehensive tool as easy-to-use as possible, the interface is divided into functional “groups.” Each group of controls is positioned within a “titled box” or on a “tabbed data page.” For example, when the *CamManager* is first opened (click the **CamManager** but-

When a *Cam Profile* file is used, the *CamManager*™ is no longer available (works only with 10-point cam files data). If you attempt to open the *CamManager*, a dialog will let you know that if you proceed, all current **Lobe-Profile** data will be converted to 10-Point data. If you click OK, the simulation will convert all **Lobe Profiles** to 10-point data that closely matches the original **Lobe Profiles**.

Lobe Profile Data And The CamManager

Profile	10-Point	V-V-T Activation: 5000 rpm		
(Modeling Input)	IVO	IVC	EVD	EVC
0.006-in Timing:	59.1	98.9	88.0	40.0
720-Based Timing:	300.9	63.0		
0.050-in Timing:	18.2	6.0		
20-Based Timing:	341.8	60.0		
Timing Changes:	0.0	0.0		
(Max Lift to TDC):	110.0			
(cancel+)/Retard(-):	0.0			
(Measured Values)	IVO	IVC	EVD	EVC
0.006-in Valve Lift:	59.1	98.9	88.0	40.0
0.050-in Lobe Lift:	18.2	6.0		
Ramp Dynamics:				
Acceleration Rates:	2.13			
Angle (Weighted):	109.9			
ing Measurements				
0.006-in Valve Lift:	338.0	308.0		
0.050-in Lobe Lift:	260.1	262.0		
0.050-in Valve Lift:	277.0	271.0		
0.050-in Valve Lift:	27.0	70.0	73.0	18.0

Warning!

A cam lobe is currently using imported profile data. Since the CamManager is designed to modify individual cam timing points, it will not work with fixed profile data. If you choose to continue, the lobe profile(s) will be converted to modifiable 10-point timing data.

Do you wish to continue?

OK Cancel

Camshaft Category—The CamManager™

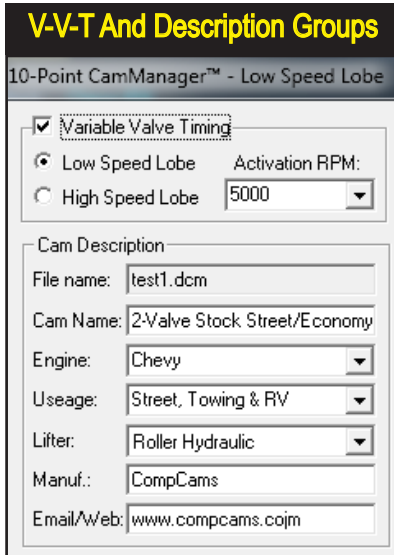

V-V-T And Description Groups

10-Point CamManager™ - Low Speed Lobe

Variable Valve Timing

Low Speed Lobe Activation RPM: 5000

High Speed Lobe

Cam Description

File name: test1.dcm

Cam Name: 2-Valve Stock Street/Economy

Engine: Chevy

Usage: Street, Towing & RV

Lifter: Roller Hydraulic

Manuf.: CompCams

Email/Web: www.compcams.com

The **CamManager Variable-Valve-Timing and Cam Description** groups are located in the upper-left of the main dialog box. Use these features to activate V-V-T and set the switch-over rpm.

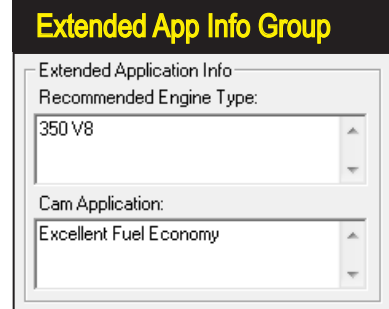

Extended App Info Group

Extended Application Info

Recommended Engine Type:

350 V8

Cam Application:

Excellent Fuel Economy

The **Cam Description** and **Extended Info** groups allow you to enter basic information about the current cam. All information in these groups is optional and has no effect on the simulation.

ton in the **Camshaft** category), you will see the following groups: **1)** *Variable Valve Timing* in the top-left corner, **2)** The *Cam Description* group is located just below it, **3)** Below that are the *Extended Application Info* and *Estimated Lifter Acceleration* displays, **4)** There are three **Tab**s in the top-center of the dialog box that access the *Camshaft Specs*, *Valve-Event Timing*, and *Search For CamFiles* pages, **5)** In the lower portion of the dialog is the *Camshaft Timing Diagram*, that shows all critical valve-timing specifications at a glance, **6)** On the right is a group of buttons that load and save 10-Point CamFiles.

Each of these groups of controls has a specific functionality that is detailed here:

Variable-Valve-Timing Activation/Selection Group (top-left corner in *CamManager*)

The *Variable Valve Timing* (V-V-T) model in the simulation, as described earlier, functions like the (dual lobe) VTEC system used in some Honda engines. At low speeds, the engine operates on the *Low-Speed Lobe*. Then, at some higher engine speed (selectable from 2500 to 8000rpm), the valvetrain switches over to the *High-Speed Lobe*. Activate V-V-T by placing a checkmark in the box next to the **Variable Valve Timing** field; this group also contains the high-speed lobe **Activation RPM** field (both controls are duplicated in the **CAMSHAFT** category).

Cam Description Group (upper-left in *CamManager*)

Basic information about the current cam is displayed in this group (most of this information is obtained from cam manufacturer's catalog listings or can be modified or manually entered at any time). The **Filename** field displays the name of the currently loaded 10-Point CamFile. The **Cam Name** provides a short description of the cam. The **Engine** field indicates the engine family

Camshaft Category—The CamManager™

for which the camshaft was designed. The **Usage** field indicates the intended application. The **Lifter** field displays the lifter technology used with this cam. The **Manufacturer** field displays the manufacturer/designer of the cam. And the **Email/Web** field provides contact info. The **Engine**, **Usage**, and **Lifter** fields have suggested entries available in drop-down menus. And although you can skip entering any information into these fields, we recommend that you complete them since this data can help locate the camshaft when performing CamFile searches, described later.

About Entered Text And Special Characters: *If you paste data into any of the data fields in the Cam Manager (e.g., using the Ctrl-C and Ctrl-V cut-and-paste functions), the simulation will examine the text for special (non-standard-text) characters. If any are found, they will be replaced with spaces. If this is not done, Camfiles or Engine files may not open properly and can cause program crashes.*

Extended Application Info (left-center in CamManager dialog)

Additional operational characteristics of the cam and engine can be included in this group. The **Recommended Engine Type** field typically displays the engines for which the cam was designed. The **Cam Application** field can be used to describe cam specs, operation, related requirements, and performance characteristics. The information in this group was usually obtained from cam manufacturer's catalogs and other published data sources. You can edit, modify, or add information to either of these fields.

Note: All data in the *Cam Description* and *Extended Application Info* groups is optional and has no affect simulation output; it is provided for information and documentation only.

Camshaft Timing Diagram (lower-center in CamManager dialog)

This graph, sometimes called a “twin-hump” diagram, shows the motion curves for the intake and exhaust valves (Note: The portion of crank rotation during which the intake and exhaust valves are closed, 120-degrees on this diagram,

The “Twin-Hump” valve motion diagram in the **CamManager** is dynamically updated anytime timing specifications are changed (see text).

Dynamic “Twin-Hump” Camshaft Timing Diagram

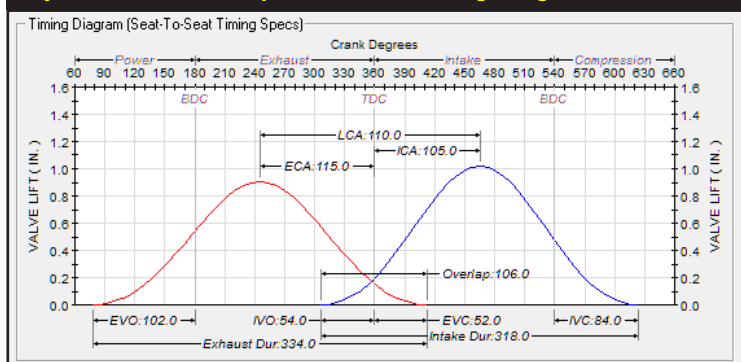

Camshaft Category—The CamManager™

Estimated Lifter Acceleration Rate

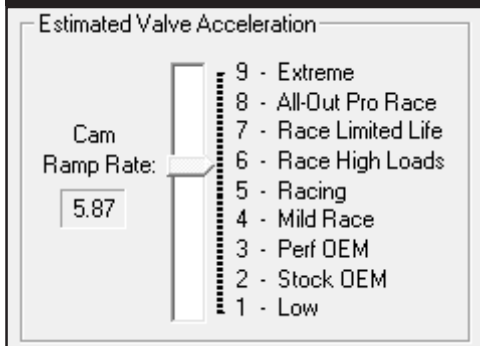

When all 10-Point timing values have been entered, the *Lifter Acceleration Rate* will be calculated and displayed. Changes in the shape of the valve-motion curves (caused by changing the valve and lifter timing points and the maximum lift for both the intake and exhaust valves) will be reflected in the displayed acceleration value.

extends beyond the left and right sides of the graph, and is not shown). Exhaust valve motion is on the left in red; the intake valve motion is on the right in blue. The valve-timing points (IVO, IVC, EVO, and EVC), Overlap, Duration, Lobe Centerlines (ECA and ICA), and the Lobe-Center Angle (LCA) are all dynamically drawn on the graph. In addition, maximum valve lift is illustrated by the height of the curves. The graph is always up to date; reflecting any changes in cam timing specifications.

Estimated Valve Acceleration (lower-left in CamManager dialog)

The simulation computes an overall valve acceleration rate and assigns a value from 1 to 9. The calculated acceleration is directly derived from the “shape” of the valve-motion curves. The greater the acceleration, typically the larger the area under the curve and the higher the average valve lift throughout the valve-motion cycle. In order to calculate Valve Acceleration, the simulation requires both the *Seat-To-Seat* and *0.050-inch Valve-Event Timing* points, plus the *Maximum Valve Lift* for the intake and exhaust valves. If all of this (10-Point) valve-event data is available, the *Valve Acceleration Rate* will be calculated

Camshaft Specs Tabbed Data Page

Camshaft Specs | Valve Event Timing | Search for Cam File

Graph Shows:
 Seat-To-Seat Timing 0.050-inch Timing
NOTE: Ramp Rate Auto-Calc requires both Seat-To-Seat and 0.050-inch Timing specs.

Intake Valve Timing		Exhaust Valve Timing	
Seat-To-Seat Duration:	318.0	Seat-To-Seat Duration:	334.0
0.050 Inch Duration:	285.0	0.050 Inch Duration:	296.0
Intake Centerline:	105.0	Exhaust Centerline:	115.0
Intake Lift At Valve (After Lash):	1.018	Exhaust Lift At Valve (After Lash):	0.905

Intake/Exhaust Lobe Relationships

Cam Lobe-Center Angle:	110.0	Valve Overlap:	106.0
------------------------	-------	----------------	-------

Use the 'Search' tab to locate and test any camfile or enter custom cam specs in the fields provided.

These tabbed pages contain data fields that accept basic cam specifications, provided in many in cam manufacturer’s catalogs. When all data has been entered, the *Camshaft Timing Diagram* motion curves will be updated. Note: Use the radio buttons to select whether to view *Seat-To-Seat* or *0.050-in* motion curves in the Timing Diagram.

Camshaft Category—The CamManager™

This tabbed page displays two columns of valve-event timing; one is Seat-To-Seat and the other is the 0.050-Inch method. Displayed are *I/O*, *I/V*, *E/O*, and *E/V*; in addition *Maximum Valve Lifts* are shown. These fields contain the 10 data points that constitute 10-Point cam data.

Seat-to-Seat Valve Timing		0.050-Inch Valve Timing	
Intake Valve Opens (IVO):	36.0	Intake Valve Opens (IVO):	17.5
Intake Valve Closes (IVC):	84.0	Intake Valve Closes (IVC):	57.5
Exhaust Valve Opens (EVO):	88.0	Exhaust Valve Opens (EVO):	69.0
Exhaust Valve Closes (EVC):	40.0	Exhaust Valve Closes (EVC):	13.0
Gross Lift At Valve (without Lash)			
Intake Valve Gross Lift:	0.651	Exhaust Valve Gross Lift:	0.651

and displayed. If the simulation does not have sufficient data to perform the calculation, “Undefined” will be displayed in this group.

Tabbed Data Pages (upper-center of CamManager dialog)

The three following data-entry-and-display pages are available as tabbed windows in the *CamManager*.

Camshaft Specs Tabbed Page

The first tabbed data page shows “published” cam specs that are typically provided by cam manufacturer’s in their catalogs or web listings. Included are **Duration**, **Intake & Exhaust Centerline**, **Lobe CenterAngle**, **Overlap**, and **Valve Lift**. When this data has been entered (except for *Overlap* and *Exhaust Centerline*, which are automatically calculated, see the Note, below), the CamManager will calculate and update valve motion data shown on the *Camshaft Timing Diagram*. The motion curves illustrate seat-to-seat valve motion curves, however, you can click the **0.050-inch Timing** radio button located at the top of the page, and the valve motion curves will be redrawn to display Lobe/Tappet timing specs.

Note: The **Exhaust Centerline** field in the CamManager is a calculated, display-only field. If this seems odd, consider that it is a directly calculated from the Intake Centerline and Lobe CenterAngle. If you *could* directly change the **Exhaust Centerline**, the program would have to change either the Lobe CenterAngle and/or the Intake Centerline to keep those values in mathematical sync. The question is: *what field should be changed? Which one should the program override?* Because of this dilemma, only the Intake Centerline and Lobe CenterAngle are directly changeable. As you view the lift curve graph at the bottom of the CamManager screen, you’ll notice that when you change the **Lobe CenterAngle** or the **Intake Centerline**, the **Exhaust Centerline** changes to make the math add up. These three variables are all mathematically linked; changing one must change at least one of the other two.

Camshaft Category—The CamManager™

Search For CamFiles Tabbed Data Page

Camshaft Specs | Valve Event Timing | Search for Cam File

Search for Cam files by any or all the criteria below:

All or parts of the file name:

A word or phrase in the file:

Look in: Browse...

Find the following specs:

IVO (SeatToSeat) From 34.0 To 38.0

IVC (SeatToSeat) From 82.0 To 86.0

EVO (SeatToSeat) From 86.0 To 90.0

EVC (SeatToSeat) From 38.0 To 42.0

Files Searched: 5589 Matches Found: 17

Name	In Folder
AMC WG-992.cam	C:\MotionSoftwareDei
Cadillac E520501.cam	C:\MotionSoftwareDei
Chevy 00234.cam	C:\MotionSoftwareDei
Chevy 00553.cam	C:\MotionSoftwareDei
Chevy 11-694-8.cam	C:\MotionSoftwareDei
Chevy 114701.cam	C:\MotionSoftwareDei
Chevy 114711.cam	C:\MotionSoftwareDei
Chevy 131281.cam	C:\MotionSoftwareDei
Chevy 132561.cam	C:\MotionSoftwareDei
Chevy 168771.cam	C:\MotionSoftwareDei
Chevy E129873.cam	C:\MotionSoftwareDei
Chrysler 691191.cam	C:\MotionSoftwareDei

Search

The *Search For CamFiles* “tabbed” page provides a way to rapidly locate 10-Point CamFiles. You can search through thousands of CamFiles and locate only those that meet your criterion.

Valve-Event Timing Tabbed Page

The second tabbed data-entry page displays valve-event timing for both seat-to-seat and 0.050-inch timing specs. Included are **IVO**, **IVC**, **EVO**, **EVC** and **Maximum Valve Lifts**. When this data is complete, the simulation will (re) calculate the Camshaft Specs and use the new data in the simulation. Both seat-to-seat and 0.050-inch valve-event values must be entered (completing all data fields on this tabbed page), before a simulation can be performed.

Note: The fields shown in the *Valve-Event Tabbed Page* constitute the 10 data values defined in 10-Point cam data.

Search For CamFiles Tabbed Page

The third tabbed page provides considerable versatility in locating 10-Point CamFiles for your test engine. Search through thousands of CamFiles and locate only those that meet your criterion. For example, you can find all the cams designed for a Honda, or locate all cams that closely match the specifications discovered in an *Iterator*™ test series (more on the *Iterators* later). If you would like to search for specific filenames or cam descriptions, first enter any search terms into the **Criteria** fields. If you would like to locate CamFiles that fall within a range of timing values centered around the current camshaft timing (the current cam is the cam currently used in the simulated engine), check the box labeled **Find The Following Specs**. Finally, click the **Search** button to perform a search of all CamFiles found in the folder listed in the **Look In** field *and in any folders that are nested below that folder* (a full *recursive* search for all .DCM, .CAM, and .SCM files is performed). When a list of matching CamFiles is presented, simply click on any file to view its characteristics (use the up-and-down arrow keys to quickly move through the results list). Transfer any CamFile into the CAMSHAFT component category and into the simulated engine by clicking **Apply** (“installs” the cam and leaves the *CamManager* open) or **OK** (“installs” the cam and closes the *CamManager*).

Camshaft Category—The CamManager™

Note: To extend the search capabilities of the CamManager, a *10-Point Cam Data Library* is included with Dynomation6 and is available for DynoSim6. You can install these additional library files into the normal directory structure of the simulation (the installer is provided on the Dynomation6 CD or on the optional CamDisk for DynoSim6), adding more than 6000 CamFiles to those already available to the *CamManager*.

CamManager Button Functions

The standard **OK**, **Cancel**, and **Apply** buttons transfer (or Cancel) any changes made in the CamManager. The **Clear** button erases all data in the CamManager in preparation for entering all specs from “scratch.” Finally, the **Open** and **Save** buttons are used to load and save cam files (using **Apply** updates the simulation with the current cam specs and leaves the *CamManager* open).

Important Note: Keep in mind that if you enter or change cam specifications within the *CamManager* *after* saving or retrieving a CamFile, the *changed cam data* WILL be saved in the engine (.DXML) file *but NOT in a separate CamFile* unless you specifically **Save** the modified cam data to a CamFile on your computer.

Loading 10-Point CamFiles

The *CamManager* is the “central clearing house” through which you can load, import, save, and search for 10-Point CamFiles. Here is a quick overview of how to load and save various CamFiles:

Opening .DCM, .SCM, and .CAM Camfiles (Motion Software CamFiles)

The CamManager will **Open** camfiles that were either saved by Dynomation6 or DynoSim6 (.DCM file) or other Motion Software engine simulations. To open any of these files, simply click the **Open** button in the CamManager and select the desired file type from the *File Open* dialog box. Here are the 10-point camfiles compatible with this simulation:

<u>10-Point Cam-Timing Files</u>	<u>File Extension</u>
Dynomation-5 & -6 CamFiles	.DCM
DynoSim6 CamFiles	.DCM
DynoSim-4 & -5 CamFiles	.CAM
SC-DynoSim CamFiles	.SCM

CamManager Buttons

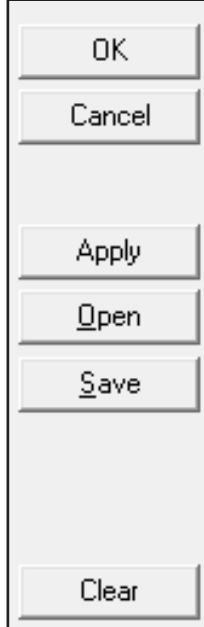

The CamManager uses the standard **OK**, **Cancel**, & **Clear** buttons. **Open** and **Save** loads and saves 10-Point Camfiles.

Camshaft Category—The CamManager™

To import any of these camfiles, open the *CamManager*, click the **Open** button, select the desired file extension from the *Files Of Type* drop-down list, then locate the file you wish to import and click **OK**. When the dialog box closes, press the **Apply** or **OK** button in the *CamManager* to transfer the cam data into the simulation.

Saving CamFiles

Open the *CamManager*, click the **Save** button, locate the **CamFile (.DCM)** folder (or one of its subfolders), then save the current CamFile to your hard drive.

Important Note: Keep in mind that if you enter or change any cam specifications either inside or outside the *CamManager*, the changed cam **data** WILL be saved with the engine (.DXML) file but WILL NOT be saved in a separate CamFile unless you specifically **Save** the modified cam data from within the *CamManager*.

Camshaft Category—The CamManager™

Camshaft Category—Using Lobe Profiles

Importing And Using Lobe-Profile Files

Dynomation6 and DynoSim6 can Open/Import a variety of cam-data files. These files are divided into two main groups: **1) 10-Point CamFiles**, and **2) Lobe-Profile Data Files**. 10-Point cam data is primarily handled through the *CamManager* (see previous section). This portion of the Camshaft Category chapter discusses importing and using Lobe-Profile data files in your engine testing.

Note: For more information on the differences between 10-Point and Profile data, refer to **10-Point And Lobe-Profile Cam Data** earlier in this chapter.

Lobe-Profile data is virtual “snapshot” of a cam lobe (separate data-sets are used for intake and exhaust lobes). Lobe-lift data is recorded at, usually, each degree of camshaft rotation. This is accomplished by installing the cam in a special, lathe-type fixture designed to measure lifter rise as the cam is rotated on centers. Audie Technology, and several other companies, manufacture these devices. Profile files vary in format, but most contain 360 data points. Some profile files also contain data-sets for more than one lobe, centerline data, application info, etc.

The simulation can **Import** several common Lobe-Profile file formats.

Supported Cam-Profile Files

CamPro
CamProPlus
Cam Doctor
S96

Common File Extension

.P1 and .P
.CPP
.CXX (XX = lobe ID numbers)
.S96

CamPro and CamProPlus (CPP) Profile Files

CamPro files were developed by Audie Technology, Inc. The file extensions for *CamPro* files are **.Px** or **.Pxx**, where **x** or **xx** is usually the cylinder number of the cam lobes. *CamProPlus* files have a **.CPP** extension. These files

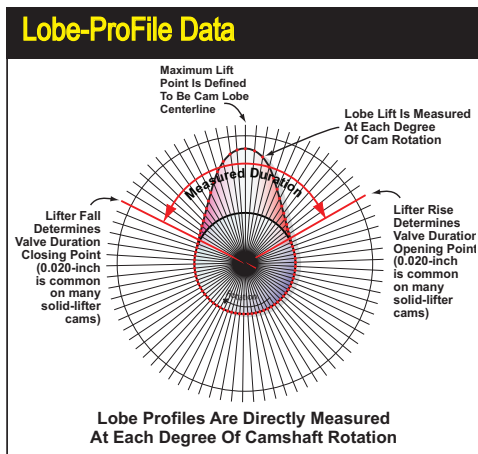

Lobe-Profile data is made up of lobe-lift data recorded for the intake and exhaust lobes (by installing the cam in a special fixture designed to measure and record this data). The simulation can individually import intake and exhaust data from several common lobe-profile formats.

Camshaft Category—Using Lobe Profiles

contain both numeric and binary (boolean) data. All text-based data is ASCII format. Each CamProPlus file can contain data for one or more lobes. The first few bytes in the file hold a special identifying code and a revision letter. This is followed by a header section with information on the test setup used to measure the lobes and other details. The file next contains a table with text-based, descriptive entries for each lobe (the table may contain “extra” unused entries). The actual lobe measurements follow the table.

Cam Doctor Profile Files

Profile files are ASCII format (text-based). The file extension is **.Cx** or **.Cxx**, where **x** or **xx** is the cylinder number of the cam lobes contained in that file. Each file typically encapsulates data for one intake and one exhaust lobe. After several lines of header information, the lobe-lift data encompasses the next 360 lines (lift values are recorded for each degree of cam rotation). Each data line provides two values: the intake and exhaust valve lift, just as they were read from the sensors used on the measurement fixture. The centerline of the cam lobe can fall at any location in the data set, since data recording begins when the rotary-encoder transmits an index pulse and the position of this timing pulse depends upon how the encoder was attached to the end of the camshaft. The data (numbers) found in the header lines can be used to locate the centerline, but it is a complicated process. Instead, most users simply set the centerline after the data file is processed.

The S96 Profile Files

This file format was invented by Harvey Crane (it is similar to an earlier **.396** file format, but with “smoothed” data). It is ASCII encoded (text based) with one lift value per line, and data is spaced in 1-cam-degree increments. It contains 396 lines of data; 360 points plus 36 additional points of overlapping data. Harvey included this redundant data as a quality check for his measuring

CamProPlus Measuring Tool From Audie Technology

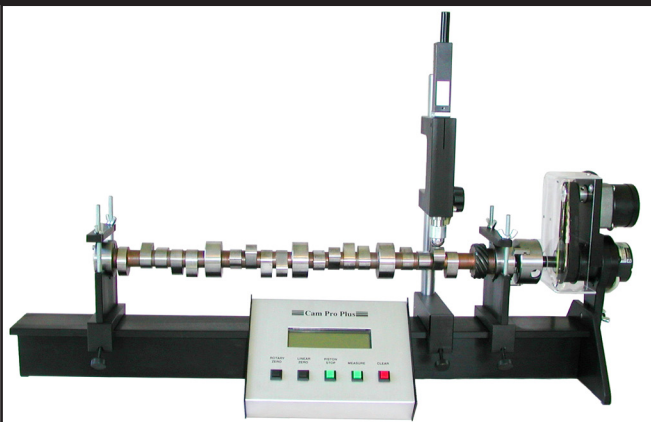

Cam Pro Plus is a software and hardware package for measuring and analyzing lobe- and valve-motion profiles. Developed by Audie Technology (www.audietech.com), it can measure cams using this test stand or when they are installed in the engine. Several software packages are available for advanced cam-motion analysis.

Camshaft Category—Using Lobe Profiles

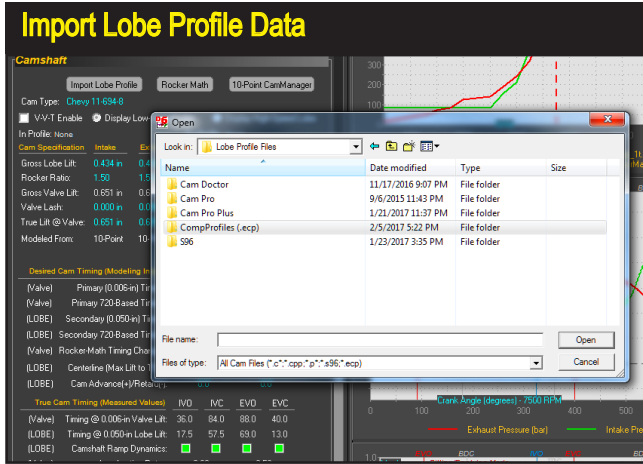

The simulation can Import many of common Profile file formats, including CamPro, CamProPlus, Cam Doctor, CompCams ECP, and S96. Press the *Import Lobe Profile* button in the Camshaft category to open the file-selection dialog shown here. This dialog lists several lobe profile groups that are supplied with Dynomation6 (included for testing and familiarization with profile-file usage).

process. Peak lift is always located in the middle of the data set. Two common variations of S96 exist: 1) With peak lift on line 180 (the overlapping points are located at the end of the file), and 2) With peak lift on line 198 (with the overlap data split between the start and the end of the file).

The .ECP Profile Files

CompCams lobe-profile format was developed by Motion Software, Inc. The lobe-profile data in these files was provided by CompCams, Inc, and (as of 2018) includes a large portion of the CompCams catalog. The raw profile data was processed and saved in .ECP files (Encrypted Comp Profile) in a protected format that prevents direct lobe copying and duplication. ECP files are only readable by Dynomation. The format protection does not affect file loading or accuracy when using these files in the simulation.

Note: The simulation automatically handles the subtleties of reading and interpreting Lobe-Profile file formats; refer to the following sections for help in using profile data in your simulations.

How To Import Lobe-Profile Data

Press the *Import Lobe Profile* button in the *Camshaft Category* to begin the import process. When the file-open dialog appears, select the desired sub-folder and file (review Lobe Profile Formats described in the previous section), then click **OK**. A *Lobe Profile Import* dialog will open to help you assign lobe data to a specific valve, set centerlines, and make other determinations about the data obtained from the file.

Here are the key features and data-entry groups in the *Cam Profile Import* dialog:

Camshaft Category—Using Lobe Profiles

Import Lobe Profile Dialog

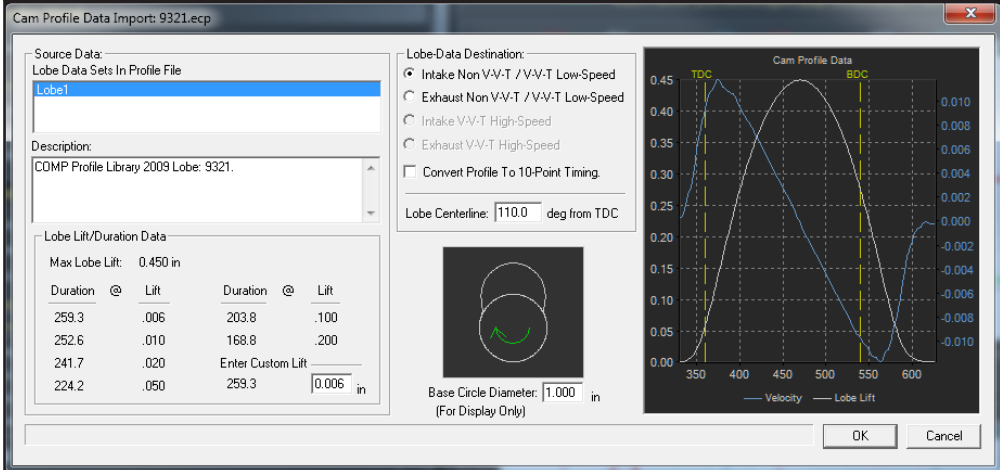

After you have selected a lobe profile file, this dialog will open and help you verify the data and assign the lobe to any of four possible destinations: 1-Intake, 2-Exhaust, 3-Intake of the VVT High-Speed Cam and 4-Exhaust of the VVT High-Speed Cam.

Lobe Source-Data List

A list of the lobes in the selected file are displayed in the top-left *Source Data* list. Some file types (like .S96) will have one or two lobes, while other files (like CamProPlus files) may have several profiles included in the file. Click on any lobe described in the Source List to apply its data to the other fields in the import dialog.

Description

When any lobe is selected from the Source List, information about the profile data may be displayed in the Description box. Many profile files will only have simple lobe identifications, like “Intake,” “Exhaust,” or other brief descriptions of the selected lobe, while other files may offer more detailed information.

Lobe Lift and Duration

Since lobe-profile data only consists of lobe-lift values recorded at each cam degree, lobe duration must be calculated from lift data (keep in mind that we are referring to **Lobe Duration** not *Valve Duration*; to determine valve duration, multiply the lobe lift values by the rocker ratio and then subtract any valve lash). Lobe duration is determined by the lobe lift height selected for the beginning and ending points. Since the SAE standard starting-lift value is 0.006-inch, and since the most common rocker ratio is 1.5:1, the lobe lift for the same duration would be $.006 / 1.5$, or 0.004-inch. However, many cam manufacturer's use their own values to rate lobe duration. Common values are 0.006-inch, .0068-inch, 0.020-inch, 0.050-inch, 0.058-inch, and even 0.100

Camshaft Category—Using Lobe Profiles

and 0.200-inch are used. The simulation displays the lobe duration for many of these lobe lift points. In addition, you can enter any lift value in the **Enter Custom Lift** field and the corresponding duration will be calculated.

Note: Once lobe-lift data is imported, the valve seat-to-seat duration displayed in the Camshaft Component category is determined using 0.006-inch valve lift points (includes rocker ratio and lash). On the other hand, 0.050-lift lobe duration is determined from the 0.050-inch lobe/tappet lift points and does not include rocker ratio or lash.

Lobe-Profile Rendering And Base-Circle Diameter

The *Lobe Profile Import* dialog also includes an illustration of the lobe selected in the Source List that is rendered from actual lobe-lift data. Use this illustration to make sure there are no missing points or interruptions in the lift curve; if you see any discontinuities, the profile data in the file is invalid.

Note-1: Since profile data only indicates how far the lifter rises above the base circle of the cam (not the actual base-circle diameter), the simulation has to make a calculated “guess” of the base-circle size to render the profile. If the lobe-to-base-circle size relationship looks odd, you can enter a different base-circle diameter that may improve the “look.” This display is only provided as a check for lift-data completeness; base-circle size does not affect the data used in the engine simulation.

Note-2: The arrow shown in the cam rendering indicates a normal clockwise rotation (cam rotation is always assumed to be clockwise); the opening flank is on the right side of the illustration and the closing ramp is on the left.

Lobe-Data Destination

The profile data associated with lobes selected in the *Lobe Source-Data List* are assigned to either an intake or exhaust valve (and in the case of V-V-T cam modeling, to the high-speed Intake or Exhaust valve) using the *Lobe-Data Destination* group. This data-entry area contains either two or four radio but-

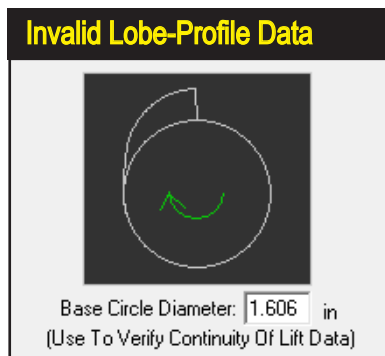

The cam-lobe image (rendered from lift data in the profile file) can confirm the validity of the data file and help you get a general “feel” for the shape of the lobe. The lift curve shown on the left is missing the opening ramp and is invalid.

Camshaft Category—Using Lobe Profiles

Assign Lobe Data To A Simulation Valve

Lobe-Data Destination:

- Intake Non V-V-T / V-V-T Low-Speed
- Exhaust Non V-V-T / V-V-T Low-Speed
- Intake V-V-T High-Speed
- Exhaust V-V-T High-Speed
- Convert Profile To 10-Point Timing.

Lobe Centerline: deg from TDC

The lobe profile selected in the *Lobe Source-Data List* can be assigned to either an intake or exhaust valve (and in the case of V-V-T cam modeling, to either of the high-speed cam lobes) using the *Lobe-Data Destination* group. The Centerline for the lobe data can also be entered in this group. With a known centerline, the simulation is able to calculate Seat-To-Seat Valve- and 0.050 Lobe-Event timing (the simulation will set a default centerline value of 110.0 degrees whenever the *Lobe Profile Dialog* is opened).

tons, depending on whether *Variable Valve Timing* is currently active. Notice that the radio buttons allow the selection of only one destination.

The procedure here is to select a lobe profile, assign it to a specific intake or exhaust valve, then close the Import Dialog to complete the import for one lobe. Reopen the Import dialog to import additional lobe profiles.

Convert Wave-Action Profile Data To 10-Point Timing

Lobe-profile data can be “handed over” to the simulation in two ways: **1)** You can directly import the “raw” valve-lift data into the *Wave-Action* simulation (this is the default method). When this is done, *Profile* data will be used “as-is” to determine valve motion, or **2)** By checking the ***Convert Profile Data To 10-Point Timing***, you can force the conversion of *Profile* lobe-lift data into *10-Point* timing values.

Note: You can still convert the lobe-profile lift data to 10-Point modeling at any time buy simply clicking the “->10-pnt” (Convert To 10-Point) buttons in the Camshaft category. Remember that profiles files are “fixed,” while *10-Point* timing can be edited or modified in any way (you can modify valve-event timing, lift, etc.).

Lobe Centerline (in crank degrees)

Lobe-lift profile data must be “synchronized” with crankshaft and piston movement to be useful. *Lobe Centerline* is the data point that fixes the rotational index, in crank degrees, from the center of the lobe-profile data (point of maximum lift) to Top-Dead-Center piston position. You can enter *Lobe Centerline* data in the Import Dialog or you can enter (or modify) this value within the *Camshaft Category*.

Lobe-Lift And Acceleration Graph

To help you visualize the profile data selected from the Source List, lift and

Camshaft Category—Using Lobe Profiles

Choosing Lobe Centerline

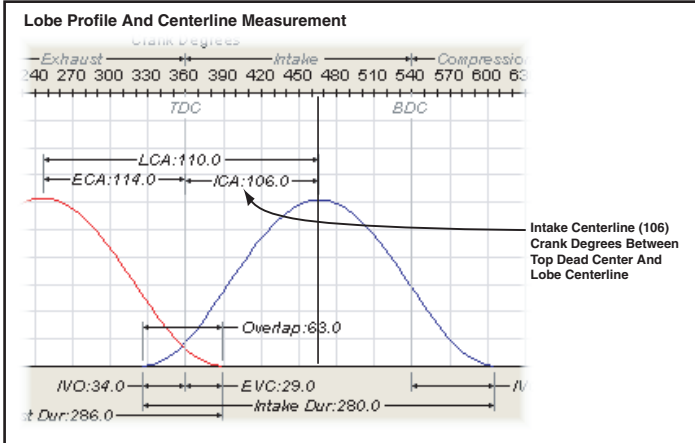

A lobe-lift profile must be “synchronized” with crankshaft and piston movement to be useful. The Lobe Centerline Angle (shown here as an LCA of 106 degrees) is the distance, in crank degrees, from the center of the lobe-profile data (in this case, the point of maximum intake-valve lift) to the Top-Dead-Center piston position.

acceleration curves are displayed in the *Lobe Lift and Acceleration Graph*. Keep an eye out for rough or bumpy curves that can indicate poor recorded data quality during cam lobe measurements.

Press the **OK** button in the *Import Dialog* to transfer the cam file data into the **CAMSHAFT** Category and update the simulation with the new cam specs..

Tuning And Modifying Profile Cam Data

Profile files, as mentioned, consist of hundreds of data points that define the position of the cam follower throughout its lift range. Because these points are

The Lobe-Lift and Acceleration Graph displays data for the profile selected in the *Lobe Source-Data List*. Use the graph to get an overall visualization of the lift curve and acceleration rates of the profile. A roughly shaped curve can signal erroneous data in the profile.

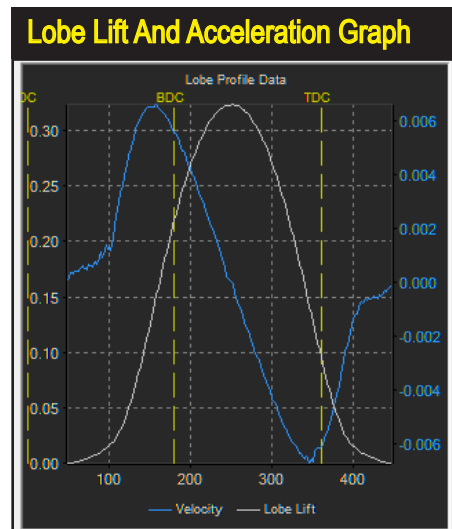

Camshaft Category—Using Lobe Profiles

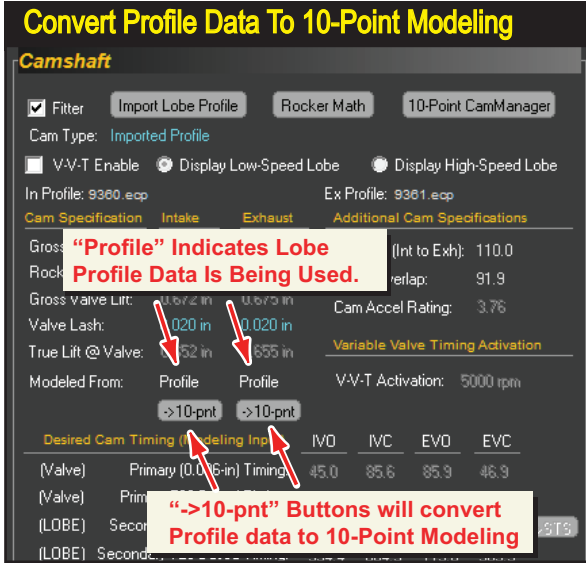

After a *Lobe Profile* has been imported into the simulation, the *Modeled From* field(s) in the Camshaft category will display *“Profile.”* You convert to *10-Point* modeling at any time by clicking a *“->10-pnt”* (Convert To 10-Point) button. Profile data for that lobe will be discarded and 10-Point valve-event timing will be used that matches the profile data as closely as possible.

fixed, they can not be individually changed without corrupting the lift curve. Basically, profile valve-event timing (IVO, IVC, etc.) is “built into” the data and cannot be altered without re-defining the entire profile. However, there are a few tuning “knobs” that you can turn when using Profile data without converting into 10-point data. Modifying the following cam specifications offer some options when Profile data is being used:

Timing Point/Specification

Cam Advance and Retard

Intake Centerline

Exhaust Centerline

Rocker Ratio

Valve Lash

Comment

Shifts entire lobe profile

(see following text for details)

Shifts entire intake lobe timing

Shifts entire exhaust lobe timing

Changes lobe-lift-to-valve-lift ratio and has some affect on duration

Affects opening/closing timing and has some affect on duration

When Profile modeling is being used, you will notice that many of the valve-event specifications within the Camshaft category are dimmed and cannot be directly modified. To “unlock” all timing data fields, you must use the *“->10-pnt”* (Convert To 10-Point) buttons to convert profile data into 10-point timing; this allows you to modify all cam timing data, but keep in mind that converting to 10-point data will create...usually small...valve motion differences from the original cam Profile curve.

Camshaft Category—Cam Adv/Ret

Advance/Retard Cam Timing

The simulation allows direct entry of Intake and/or Exhaust camshaft lobe advance or retard values for both Profile and 10-Point cam modeling. Changing these specifications from zero (the default) to a positive value advances the cam lobe (in crank degrees) while negative values retard the lobe.

Why advance or retard the cam? It's just about the only valve-timing change that can be made after the camshaft has been installed. While it is sometimes possible to improve performance using this technique, let's investigate what happens when valve events are advanced or retarded in unison.

Tuning A Single-Cam Engine

It is generally accepted that advancing the cam improves low-speed power while retarding the cam can improve high-speed power. When the cam is advanced, IVC and EVC occur earlier and that can improve low-speed performance; however, EVO and IVO also occur earlier, and these changes tend to improve power at higher engine speeds, but to a lesser extent. The net result of these “conflicting” changes typically is a slight boost in low-speed power. The same goes for retarding the cam. Two events (later IVC and EVC) boost high-speed power and two (later EVO and IVO) boost low-speed performance, but again, to a lesser extent. The net result is often a slight boost in high-speed power.

Advancing or retarding a camshaft under these conditions has the overall affect of reducing valve-timing efficiency in exchange for slight gains in low- or high-speed power. Consequently, many cam manufacturers recommend avoiding this tuning

To ensure the most accurate cam timing and to facilitate tuning, a gear drive is often used in high-performance applications. This a CompCams drive was designed for GM LS engines (with three-bolt cams on all 24x and 58x LS engines).

DOHC Cam Sprockets



Camshaft Category—Cam Adv/Ret

Advance/Retard Menu

Camshaft

Filter: Input: Lobe Profile Rocker Math 10-Point Cam Manager

Cam Type: Imported Profile

V-V-T Enable Display Low-Speed Lobe Display High-Speed Lobe

In Profile: 9300.eop Ex Profile: 9301.eop

Cam Specification	Intake	Exhaust	Additional Cam Specifications
Gross Lobe Lift:	0.395 in	0.397 in	Lobe CL (Int to Exh): 110.0
Rocker Ratio:	1.70	1.70	Valve Overlap: 91.9
Gross Valve Lift:	0.672 in	0.675 in	Cam Accel Rating: 3.32
Valve Lash:	0.020 in	0.020 in	
True Lift @ Valve:	0.652 in	0.655 in	

Modeled From: -10 (Retard) to +10 (Advance)

Desired Cam Tim	IVC	EVO	EVC
(Valve) Prim	85.6	85.9	46.9
(Valve) Prim	0	625.6	94.1
(LOBE) Secor	64.3	66.4	25.9
(LOBE) Second	4	604.9	113.6
(Valve) Rocker	0.0	0.0	0.0
(LOBE) Certk	110.0	110.0	
(LOBE) Cam	00		

V-V-T Activation: 5000 rpm

True Cam Tim	IVC	EVO	EVC
(Valve) Timing	85.6	85.9	46.9
(LOBE) Timing	64.3	66.4	25.9
(LOBE) Cam	3.33	3.90	
(Valve) Certk	110.3	109.5	
(Valve) Durator	310.6	312.8	
(LOBE) Durator	270.4	272.3	
(Valve) Durator	271.0	273.0	
(Valve) Timing @ 0.050 in Valve Lift	26.0	65.0	67.0

The simulation allows direct entry of camshaft advance or retard for each lobe (permits DOHC modeling). Changing this specification from zero (the default) to a positive value advances the cam lobes; negative values retard the lobes. See text for more information on how these changes can affect engine output.

technique. If advancing or retarding allows the engine to perform better in a specific rpm range, the cam profile was probably not optimum for the engine in the first place. More power can be found at both ends of the rpm range by installing an optimized cam rather than advancing or retarding the wrong cam. However, if you already own a specific camshaft, advancing or retarding overall timing may offer

DOHC Cam Sprockets



In DOHC engines, like the Honda VTEC and many other engines, where separate cams are used for the intake and exhaust lobes, the cam advance/retard can be set independently for the intake and exhaust cams. In the real world, this tuning is easily accomplished with adjustable cam sprockets, like these from ZEX. Adjustable timing sprockets can also compensate for milled deck and head surfaces that can alter cam timing.

Camshaft Category—Cam Adv/Ret

some “fine tuning” capabilities.

Tuning DOHC Engines

Tuning DOHC engines with individual intake and exhaust cams is a straightforward process. While changing cam timing on an engine with a single cam forces you to change ALL lobes the same amount and in the same direction—often reducing any benefits you may have gained—on DOHC engines cam tuning takes on a much greater significance. When you install an optimum cam for a specific application, you can expect it to produce peak power (or torque) when installed “heads-up,” or without any advance or retard. However, engine builders often find improvements by advancing one cam and retarding the other. This is especially true in turbocharged applications, where advancing the intake cam and retarding the exhaust cam increases the Lobe-Separation Angle (also called the Lobe-Centerline Angle, or LCA), reducing valve overlap, which sometimes improves forced-induction efficiency.

Dyno testing has shown that it is sometimes impossible to predict how the engine will respond to intake- or exhaust-cam advance and retard. This is may be due to subtleties within, and interactions between, the induction and exhaust systems. While this simulation will give you valuable feedback, this fine-tuning process should be confirmed on a real-world dynamometer.

Note: Make sure you keep in mind that changing cam advance or retard on

DOHC Gear Train

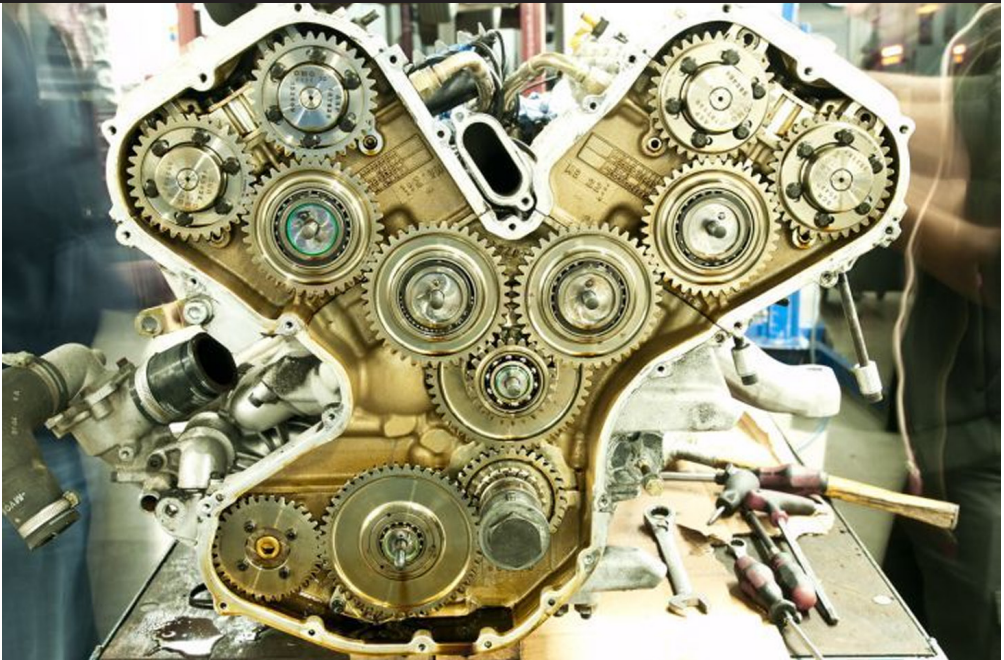

Camshaft Category—Cam Adv/Ret

a real-world engine will alter valve-to-piston clearance. Changing cam timing by 4-degrees or less will rarely cause interference problems, however, it is always the engine builder/tuner's responsibility to ensure mechanical contact between the pistons and valves does not take place at any engine speed. Just starting and idling an engine with piston-to-valve interference can damage valves, break cams, and bend valvetrain components.

Combustion Category

Combustion Category

Combustion

Compression Ratio: 13.00 Thermal Coatings: Piston AND Chamber
Combustion Space: 96.45 cc Cylinder Volume: 1157.43 cc CR Calc

Fuel Type: Gasoline Nitrous Power: 0.0 HP
Air Fuel Ratio: 12.50 Equivalence Ratio: 1.18
AF Ratio Table: Table Fuel Cooling (LHV): 150.5 Btu/Lb
Fuel Calorific Value: 20334 Btu/Lb Vaporization % (Before IVC): 100.0 %

Combustion Chamber Design: Pentroof with Squish
Chamber Timing Requirements: 15.0 Deg Chambers...

Ignition Timing (Spark Timing)

Basic Ignition Timing @ Crank: **** Deg BTDC
Timing Advance (Mechanical): 0.0 Deg Per 1000 RPM
Until: 3000 rpm

Estimate Ignition Timing (For Best Torque @ Each RPM Point)

The Combustion Category includes Compression Ratio, Thermal Coatings, Fuel Type, Air/Fuel Ratio (fixed or adjustable for each rpm point), Fuel Vaporization within the intake tract (before IVC), Combustion-Chamber geometry, and Ignition Timing. Each of these specifications directly affect how fuel is burned in the engine. This category also includes a Compression Ratio Calculator, and a Combustion-Chamber-Selection dialog. Clicking the *Estimate Ignition Timing* checkbox, will direct the simulation to determine the *MBT* for the engine at each rpm point (see text).

THE COMBUSTION CATEGORY Applies To FE and WA Simulations, Except as Indicated

The Combustion Category contains combustion-related components and specifications. Included are *Compression Ratio*, *Thermal Coatings Modeling*, *Fuel Type* (includes spark- and combustion-ignition fuels), *Air/Fuel Ratio* (one value or a “map” of values), *Fuel Vaporization Percentage within the intake tract before IVC*, *Combustion-Chamber geometry*, and *Ignition Timing* (for spark-ignition fuels only). Each of these specifications directly affect how fuel is burned and the overall combustion efficiency. This category also includes a *Compression Ratio Calculator* (see text),

Combustion Category

Compression ratio is calculated by dividing the total volume within the cylinder when the piston is located at **Bottom Dead Center (BDC)** by the volume that exists when the piston is positioned at **Top Dead Center (TDC)**.

Basic Compression Ratio Equation

Compression Ratio =

$$\frac{\text{Swept Cylinder Volume} + \text{Combustion Space Volume}}{\text{Combustion Space Volume}}$$

Combustion Space Volume

and a *Chamber-Selection* dialog. Clicking the *Estimate Ignition Timing* checkbox will instruct the simulation to determine the **MBT (Minimum Ignition Advance For Best Torque)** for the engine at each rpm point.

Note: When you select **Diesel** fuel, the following fields are dimmed, since they cannot be changed in compression-ignition applications:

Combustion Chamber Design: An analysis of chamber shape is not included in this version of the simulation.

Ignition Timing: Ignition point determined by the simulation

Compression Ratio and How It Is Calculated

The **Compression Ratio** menu, located in the *Combustion Component* category, establishes the compression ratio for the simulated engine (within the range of 3:1 to 30:1) for gasoline and other spark-ignition fuels or for Diesel fuel using compress-

The **Compression Ratio** field is located at the top of the *Combustion Category*. **Compression Ratio** is a comparison of the geometric volumes that exist in the cylinder (including the cylinderhead and gasket volumes) when the piston is located at **BDC (bottom dead center)** to the “compressed volume” when the piston reaches **TDC (top dead center)**. The simulation will model any compression ratio from **3.00:1 to 30.00:1**.

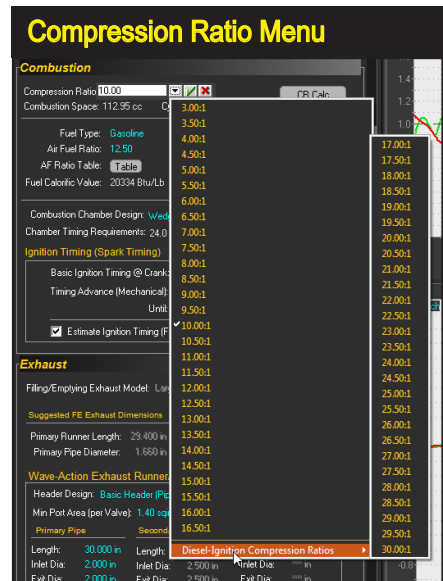

Combustion Category

sion ignition.

Compression-ratio is the comparison of two volumes in the engine, as illustrated by the “standard equation” shown nearby. The variables are: 1) *Swept-Cylinder Volume*, and 2) *Combustion-Space Volume*. While these are the only two volumes that affect compression ratio, each of these volumes is made up of multiple other volumes, so the first step in understanding compression ratio is to become familiar with these volumes.

Swept Cylinder Volume is the most straightforward: It is simply the three-dimensional space displaced by the piston as it “sweeps” from BDC to TDC, and is determined solely by the bore diameter and stroke length. The swept cylinder volume is calculated by the simulation—and displayed in the **Combustion** category—as soon as the bore and stroke have been selected for the test engine.

The other main variable in the compression-ratio equation is *Combustion-Space Volume*. This is the total volume that exists above the piston when it is positioned at TDC. This space includes the combustion-chamber volume, the volume taken up by the thickness of the head gasket, any volume added by the piston not rising fully to the top of the bore, plus any valve-pocket volume, less any volume displaced by the piston or piston dome protruding above the top of the cylinder bore (block deck). The complexity of these volumes is often a stumbling block in becoming comfortable with all aspects of compression ratio. However, the following explanation and illustrations should clarify these important concepts.

Imagine yourself as a “lilliputian,” wandering around inside the engine. Take a stroll inside the combustion space. Picture in your mind what you would see in the cylinder with the piston at TDC. The combustion chamber would look like a ceiling above you. The floor would be the top of the piston. If the piston (at TDC) didn’t rise completely to the top of the cylinder, you would see a bit of the cylinderwall around the edges of the floor, with the head gasket sandwiched between the head and block like trim molding around the room. There may be “steps” (valve pockets) in the top of the piston just under your feet (don’t trip!). If the piston had a dome, it

A good way to visualize compression ratio volumes is to imagine yourself as a “lilliputian” wandering around inside the engine. You would see the combustion chamber above you like a ceiling. Your floor would be the top of the piston. *Swept Cylinder Volume* is the three-dimensional space displaced as the piston “sweeps” from BDC to TDC, and is determined solely by the bore diameter and stroke length.

Picturing Compression Ratio And Swept Volume

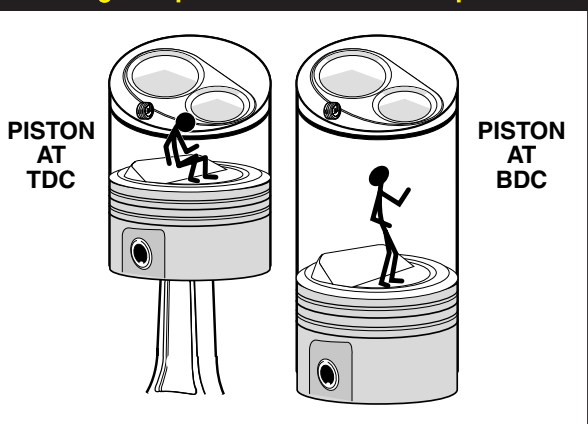

Combustion Category

might act as a small room divider rising from the floor, to, perhaps, knee high. The space in this room (combustion space) would be larger if the piston was positioned lower down the bore or if the “steps” under your feet were deeper, and it would be tighter squeeze if the room divider (dome) volume was larger. This entire space is “home” for the compressed charge when the piston reaches TDC. This is the volume that makes up the combustion space, the denominator of the compression-ratio calculation equation. Now let’s continue our tour of compression spaces, but this time we’ll explore what we see inside the cylinder when the piston is located at BDC. The very same volumes that we just described (chamber, dome, notches, gasket, etc.) are still there, but are now located well above our head. It looks like the room has been stretched, like the elevator ride in the Haunted House at Disneyland. This “stretched” volume is described in the numerator of the compression-ratio equation. It’s simply the original combustion volume plus the volume added by the “sweep” of the piston as it traveled from TDC to BDC. The ratio between these two volumes is the compression ratio.

Bore, Stroke, And Compression Ratio

Another quick look at the compression-ratio equation reveals that if engine displacement (swept volume) is increased, either by increasing the bore or stroke, the compression ratio will rise. In fact, with everything else being equal, a longer stroke will increase compression ratio much more quickly than increasing bore diameter. This is due to the fact that a longer stroke (without changing other engine dimensions) not only increases displacement, but it tends to decrease combustion space volume, since the piston moves higher the bore if the rod length and pin position are not changed (in our “lilliputian” example, raising the floor closer to the ceiling). This “double positive” results in rapid increases in compression ratio for small increases in stroke length. On the other hand, increasing cylinder-bore diameter also increases compression ratio but less significantly. This is due, in part, to the increase in *Combustion-Space Volume* that often accompanies a larger bore.

While *Combustion-Chamber Volume* is simply the volume of the chamber in the cylinder head, the *Combustion-Space Volume* is the total enclosed volume when the piston is located at TDC. This space includes the volume in the combustion chamber, plus any volume added by the piston not rising to the top of the bore, the volume within any valve pockets, and the head-gasket thickness, less any volume contained within the piston dome or displaced by the piston protruding above the top of the bore.

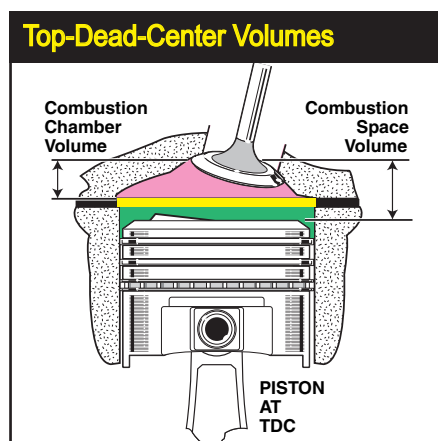

Combustion Category

Why does higher compression ratio produce more horsepower? Try to answer this question before you read the remainder of this caption. A combustion space containing twice as much volume as the cylinder produces a 1.5:1 compression ratio. Peak cylinder pressures after ignition will be about 250psi. With a combustion space about 1/10th of the volume of the cylinder, the compression ratio will be 10:1. Peak pressures reach about 1500psi. It is easy to see that the higher compression ratio generates much higher cylinder pressures. And these higher pressures exerted against the piston throughout the first half of piston travel from TDC to BDC on the power stroke increase torque and horsepower.

High Compression Boosts Power

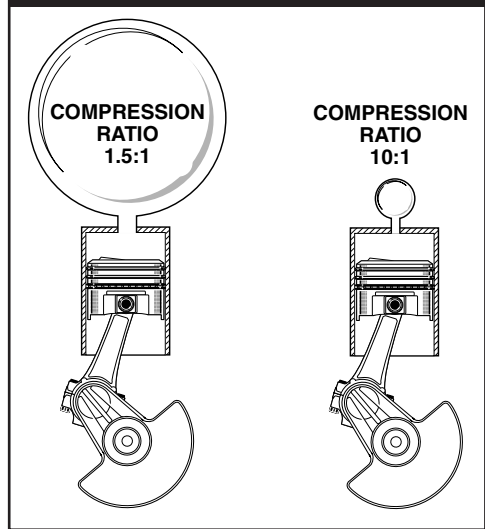

Changing combustion space—the other element in the compression-ratio equation—will also alter the compression ratio. Anything that reduces the combustion volume, while maintaining or increasing the swept volume of the cylinder, will increase the compression ratio. Some of the more common methods to accomplish this are decreasing the volume of the combustion chambers (by replacing or milling the heads), using thinner head gaskets, changing the location of the piston-pin or rod length to move the piston closer to the combustion chamber, installing pistons

Compression-Ratio Math Calculator

Compression Ratio Calculator

Current Engine Specs

Bore: 3.425 in	Cylinder Vol: 539.14 cc	Total Vol: 131.6 ci	Apply
Stroke: 3.571 in	Combustion Vol: 53.31 cc	Compression Ratio: 11.11	Cancel

Compression Ratio Volumes

Known Chamber/Piston Volumes

Select Method of Compression Ratio Calculation:

- Piston Dome/Deck/Relief Specs Known
- Measure Piston Dome/Reliefs With Burette

1 Head Chamber Volume:	36.90	cc
2 Dome Volume:	2.50	cc
3 Valve Reliefs Volume:	5.60	cc
4 Deck Clearance @ TDC:	0.045	in
Calculated Deck Volume @ TDC:	9.89	cc
5 Head Gasket Bore:	3.560	in
6 Head Gasket Thickness:	0.040	in
Head Gasket Volume:	6.52	cc

Calculated New Compression Ratio

Swept Cylinder Vol: 539.14 cc	Total Combustion Vol: 53.31 cc	Compression Ratio: 11.11
-------------------------------	--------------------------------	--------------------------

Activate the Compression-Ratio Calculator by clicking on the **CR Calc** button in the **Combustion** category. You can also open the calculator by selecting **Compression Ratio Math** from the Tools menu or by clicking on the **Compression Ratio Icon** in the Tool Bar. This tool lets you to directly enter combustion-chamber volumes, head-gasket thickness, etc., and determine their effects on engine compression. For detailed information on using the Compression-Ratio Calculator, see **Built-In Calculators** later in this manual.

Combustion Category

You can model the use of thermal coatings on the piston top or combustion chamber, or both. The more combustion heat that is kept in the cylinder, the higher the cylinder pressure and engine efficiency.

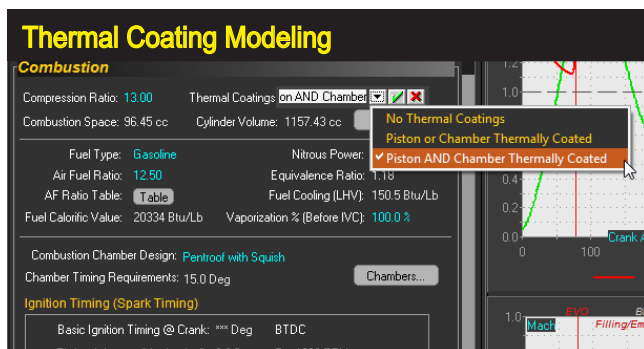

with larger domes, etc. These modifications and others can be explored using the built-in *Compression-Ratio Calculator*.

The Compression-Ratio Calculator

The simulation allows the direct selection and testing of a very wide range of compression ratios from 3:1 to 30:1. In addition, many engine builders need to use combustion-chamber volumes, head-gasket thickness, etc., to determine the compression ratio. The **Compression-Ratio Calculator**, quickly performs these functions. Detailed information on using the *Compression-Ratio Calculator* is included in the section **Built-In Calculators** later in this manual).

Piston/Chamber Thermal Coatings

You can model the use of thermal coatings on the piston top or combustion chamber, or both. Thermal coatings help keep heat in the cylinder that would otherwise dissipate into the water jackets of the engine. The more combustion heat that is held in the combustion space, the higher the cylinder pressure will be during the power stroke. This improves engine output and overall efficiency.

The menu selection lets you choose the following models: *No Thermal Coatings*, *Coating Applied To The Piston OR The Chamber*, and finally *Coatings Applied To The Piston AND The Chamber*.

Note: The model assumes that coatings applied to the chambers includes the valve heads (coating covers the entire chamber surface).

Fuel Type Menu Selection

You can also model several automotive fuels, including Diesel, plus Nitrous-Oxide injection with Gasoline or Methanol. Select any of these fuels options from the **FUEL** menu:

Combustion Category

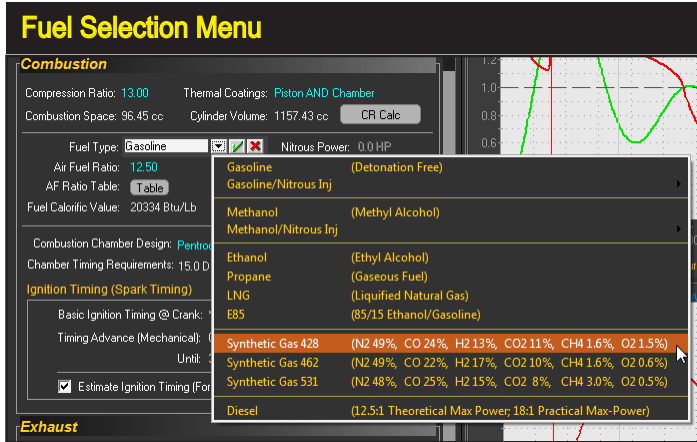

Model various fuels for dyno testing in both the *Filling-And-Emptying* and *Wave-Action* models. When any of these fuels have been selected, the commonly accepted peak-power air/fuel ratio is automatically inserted into the *Air/Fuel Ratio* field.

- Gasoline (Detonation Free)
- Methanol (Methyl Alcohol)
- Ethanol (Ethyl Alcohol)
- Propane (Gaseous fuel)
- Synthetic Gas (4 types)
- Gasoline W/Nitrous Injection
- Methanol W/Nitrous Injection
- E85 (85% Ethanol, 15% Gasoline)
- LNG (Liquefied Natural Gas)
- Diesel (Compression Ignition)

When any of these fuels have been selected, the simulation readjusts the air/fuel ratio for optimum power. This updated air-fuel ratio is displayed in the *Air/Fuel Ratio* field. Changes to the Air/Fuel ratio can be made at any time by making a selection from the Air/Fuel Ratio menu, by direct numeric entry, or by using the A/F Table to specify a unique air/fuel ratio for each rpm test point.

To use the AF Ratio Table and create a “map” of air-fuel ratios for each rpm point, click on the *Table* button in the Combustion Category. You can fill all rpm

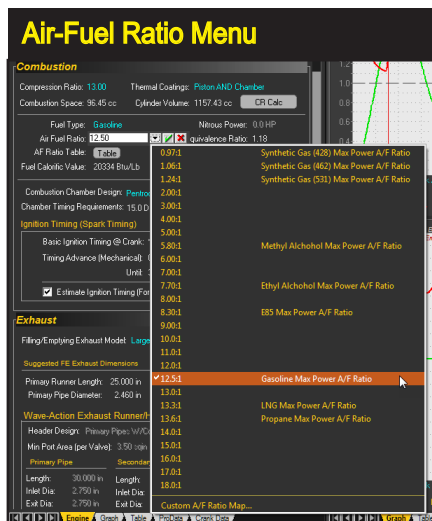

When any fuel has been selected, the air/fuel ratio is adjusted for optimum power. The updated ratio is displayed in the *Air/Fuel Ratio* field. Changes to the Air/Fuel ratio can be made at any time by selecting the Air/Fuel Ratio menu or by direct numeric entry.

Combustion Category

points with the default ratio (to initially fill the table) using the **Fill With Default** button. If you would like to switch back to using a single A/F Ratio, open the **Table** dialog again and click on the **Use Single AF Ratio** button.

Nitrous-Oxide Injection

There are many ways to boost engine power. However, nitrous-oxide injection is a particularly effective method. Developed during World War II for piston-engine fighter aircraft, nitrous-oxide gas—an oxygen-releasing substance—allows an engine to ingest more fuel while maintaining optimum air(oxygen)-to-fuel ratios. Injected into the cylinders with additional fuel, the effect is similar to instantaneous supercharging but without the losses from a belt- or exhaust-gas-driven device. Remarkable as it may

seem, as much horsepower as desired can be added, with the limitations being dangerously high cylinder pressures, detonation, or component failure. There are no subtleties here: Add more nitrous and fuel; produce more horsepower!

Most nitrous systems inject a fixed amount of nitrous and fuel (constant-flow), regardless of engine speed. In other words, when the nitrous switch is turned on, the engine will immediately produce a fixed boost in power, solely determined by the amount of injected fuel and nitrous.

The simulation models a typical constant-flow **Nitrous/Gasoline** or **Nitrous/**

The simulation can also model a varying air/fuel ratio. The **Air/Fuel Ratio Table** dialog is available by selecting the **Table** button in the **COMBUSTION** category. You can set individual AF Ratios for each rpm test point. Reset to a single AF ratio simply by pressing the **Use Single AF Ratio** button below the table.

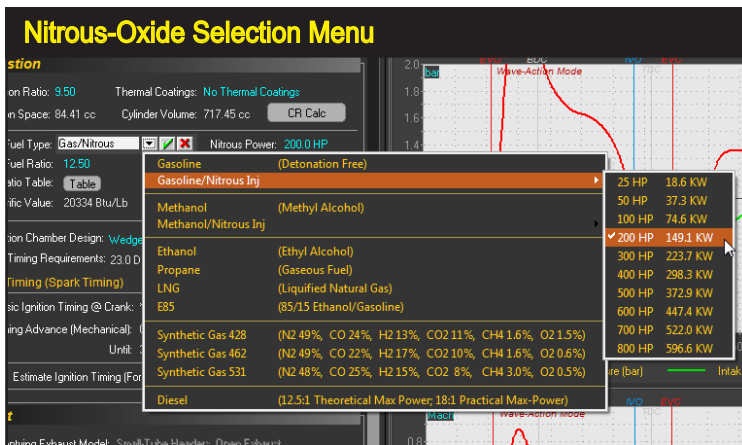
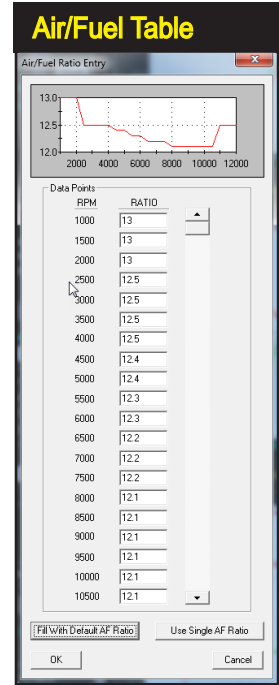

There are many ways to boost engine power, however, nitrous-oxide injection is a uniquely effective method. The simulation models constant-flow **Nitrous/Gasoline** and **Nitrous/Methanol** injection systems.

Combustion Category

Methanol injection system. Nitrous is “injected” by the simulation in precise amounts throughout specific increments of crank degrees, similarly to an actual nitrous system. You select the desired HP boost, and the simulation will calculate the Nitrous Mass Flow required to produce that power (calculation of nitrous flow is performed before the actual simulation is run, so engine design and other factors...just like in the real world...can affect the actual power output reported by the simulation). The simulation will tell you how much of the injected nitrous mass actually entered the cylinder and how much was rejected back into the intake manifold (or lost to exhaust flow). The enhanced nitrous modeling included in this version-6 simulation includes these elements in a nitrous-augmented engine:

- 1) Nitrous Inflow restriction at the intake valves
- 2) Cylinder filling (capacity vs. overflow backpressure) and gas reversion
- 3) Nitrous (and added fuel) effects on charge cooling (LHV)
- 4) Nitrous details are included in the Simulation Log and *ProTools* Printout
- 5) Enhanced Nitrous Injection is included in both the WA and FE simulations

A nitrous injection system designed to add 100 horsepower (flowing about 4 pounds per minute of nitrous oxide and additional fuel to maintain the correct air/fuel ratio), will produce a 100 horsepower boost instantly upon triggering the system. Remarkably, the engine will continue to produce an this additional 100 horsepower across the entire rpm range. That means a 100hp nitrous system activated at 2000rpm (when the engine may have been producing only about 70hp) can double or even triple power output!

These huge power boosts at low engine speeds (when each cylinder ingests

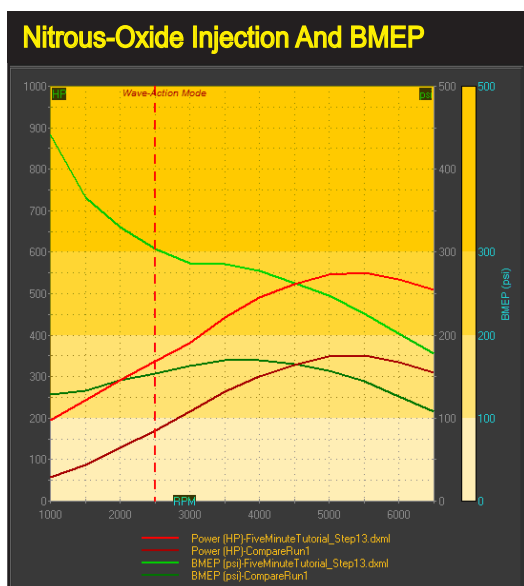

This graphic shows how cylinder pressures (in this case the BMEP shown by the green line) increase after a 200-horsepower nitrous system is activated (this pressure comparison includes colored DataZones™, discussed later in this manual). Since the simulation models a fixed-flow nitrous system, cylinder loads increase as engine speed decreases (the longer time the intake valve is open, the greater nitrous load is inducted into the cylinder). Below 3000rpm, BMEP exceeds 300psi (shown by the top, light green band). In this situation, nitrous-system activation should be delayed until 3000rpm to help maintain engine reliability.

Combustion Category

Nitrous Power Menu

Compression Ratio: 9.50 Thermal Coatings: No Thermal Coatings
Combustion Space: 84.41 cc Cylinder Volume: 717.45 cc CR Calc

Fuel Type: Gas/Nitrous Nitrous Power: 200.0
Air Fuel Ratio: 12.50 Equivalence Ratio: 1.18
AF Ratio Table: Table Fuel Cooling (LHV): 150.5 Btu/Lb
Fuel Calorific Value: 20334 Btu/Lb Vaporization % (Before IVC): 80.0 %

Combustion Chamber Design: Wedge, Closed
Chamber Timing Requirements: 23.0 Deg Chambers...

Ignition Timing (Spark Timing)
Basic Ignition Timing @ Crank: *** Deg BTDC
Timing Advance (Mechanical): 0.0 Deg Per 1000 RPM
Until: 3000 rpm
 Estimate Ignition Timing (For Best Torque @ Each RPM Point)

Exhaust
Filling/Emptying Exhaust Model: H.P. Manifolds, Mufflers W/Cat
FE Exhaust Tune RPM: 5000
Suggested FE Exhaust Dimensions

25 HP	18.6 KW
50 HP	37.3 KW
75 HP	55.9 KW
100 HP	74.6 KW
125 HP	93.2 KW
150 HP	111.9 KW
175 HP	130.5 KW
200 HP	149.1 KW
225 HP	167.8 KW
250 HP	186.4 KW
300 HP	223.7 KW
350 HP	261.0 KW
400 HP	298.3 KW
450 HP	335.6 KW
500 HP	372.9 KW
600 HP	447.4 KW
700 HP	522.0 KW
800 HP	596.6 KW

To activate any Nitrous Boost Horsepower from zero to 800hp, first select one of the *Nitrous-Injection* selections from the Fuel Type menu (which activates the *Nitrous Power Menu*), then open the *Power Menu* to enter any power value.

a large “dose” per power cycle) can generate excessive cylinder pressures. As a result, fixed-flow-rate systems often include a delayed trigger to allow the engine to reach sufficient speed to maintain safe cylinder pressures. Maintaining cylinder pressures below critical levels is essential to prevent detonation and mechanical failure.

During engine simulations with nitrous augmentation, you can keep track of cylinder pressures (for example, a BMEP greater than 300psi is usually considered borderline dangerous). For example, the nearby test graph illustrates a 350 smallblock equipped with a 200hp nitrous system. Note that BMEP pressures below 3000rpm exceed 300psi.

Note-1: BMEP (Brake Mean Effective Pressure) is an “average” cylinder pressure; when it exceeds 300psi, peak pressures often reach detonation levels and can quickly lead to mechanical failure—for a description of BMEP, refer to the *Glossary* later in this manual.

Note-2: There are other ways to help reduce low-speed cylinder pressure in a Nitrous engine including modified cam timing. It has long been known that increasing valve duration and overlap will lower cylinder pressures at lower engine speeds. This typically-unwanted phenomenon is a low-speed power killer, but combined with a nitrous-oxide injection system, it can permit earlier nitrous flow while optimizing power at higher engine speeds. Other ways to decrease low-speed cylinder pressures include reduced compression ratios, increased exhaust-system back pressure, reduced induction airflow, larger engine displacement, and of course, reducing the nitrous flow rate.

You can activate the nitrous-injection model by selecting *Gasoline/Nitrous Injection*

Combustion Category

tion or **Methanol/Nitrous Injection** from the **Fuel Type** menu (see previous page). You will see the following choices:

- **25 HP** (~1 lb/min N₂O flow)
- **50 HP** (~2 lb/min N₂O flow)
- **100 HP** (~4 lb/min N₂O flow)
- **200 HP** (~8 lb/min N₂O flow)
- **300 HP** (~12 lb/min N₂O flow)
- **400 HP** (~16 lb/min N₂O flow)
- **500 HP** (~20 lb/min N₂O flow)
- **600 HP** (~24 lb/min N₂O flow)
- **700 HP** (~28 lb/min N₂O flow)
- **800 HP** (~32 lb/min N₂O flow)

In addition to these 10 menu options, you can use the **Nitrous Power Menu** to manually enter any nitrous power value from zero to 800hp.

Combustion-Chamber Design

The **Combustion-Chamber Design** field in the **Combustion** category sets the fuel burn rate and adjusts the combustion efficiency based on the physical geometry of the combustion space.

In general, a “disc-shaped” chamber with a side-mounted sparkplug generates the lowest turbulence and flame speed. The burn-rate differences between this old technology chamber and a modern pentroof designs with squish-assisted turbulence can be as much as 30-degrees of reduced ignition timing “lead” to accommodate the faster-burn rates. A mathematical analysis of the burn process (can be thought of as simply a rapid pressure rise) reveals that peak power would be obtained if the fuel burned instantly at a crank angle slightly after TDC. This would produce the greatest push on the piston at the point at which this pressure is most efficiently

Nine combustion-chamber geometries from the slowest-burning disc shape to the fast-burn pentroof designs model most high-performance and racing engines. Clicking the *Chambers Quick-Access™* button in the Combustion Category provides an overview of these chamber shapes, including the basic Chamber Timing Requirements of these designs (timing values in the dialog assume gasoline as the fuel). Note: This dialog does not open when using Diesel as a fuel.

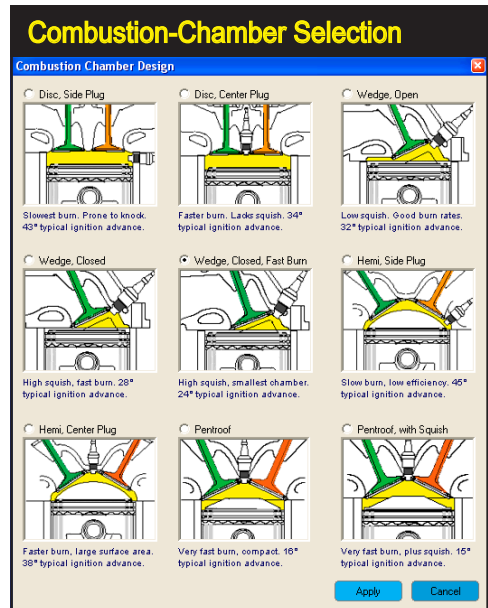

Combustion Category

converted into the highest force on the crankpin. While an instant fuel burn (and pressure rise) is not possible for several practical reasons, including knock prevention and maintaining mechanical integrity, typically a fast pressure rise in the cylinder will produce more power (reaching peak pressure at about 20- to 30-degrees ATC is typical for many high-output engines). To facilitate this, modern chamber designs are optimized for high turbulence and flame speeds while minimizing pre-ignition and detonation.

Note: As always, there are exceptions. In a nitromethane-fueled engine, the slower burn-rate hemispherical chamber is often used. In this case, there are benefits to slowing down the burn rate and giving the flame front a symmetric volume in which to propagate. With nitromethane this results in a more uniform application of the huge cylinder pressures produced by this powerful racing fuel. The overriding consideration here is reliability not peak pressures!

The simulation provides nine combustion-chamber geometries from the slowest-burning disc shape, provided primarily for comparison purposes, to the fast-burn pentroof designs used in many modern high-performance and racing engines. Clicking on the **Chambers** Quick-Access™ button (not active for Diesel fuel) provides an overview of these chamber shapes, including the basic *Chamber Timing Requirement* (assumes gasoline as the baseline fuel).

The *Chamber Timing Requirement* is based on the *time lag* between the sparkplug discharge, referred to as the **SparkPoint**, and the beginning of cylinder pressure rise. This delay can be considered as the innate rate at which fuel burns in that chamber geometry. This is the *least possible timing advance* that the engine will need to produce optimum power with that chamber at low engine speeds. As speed

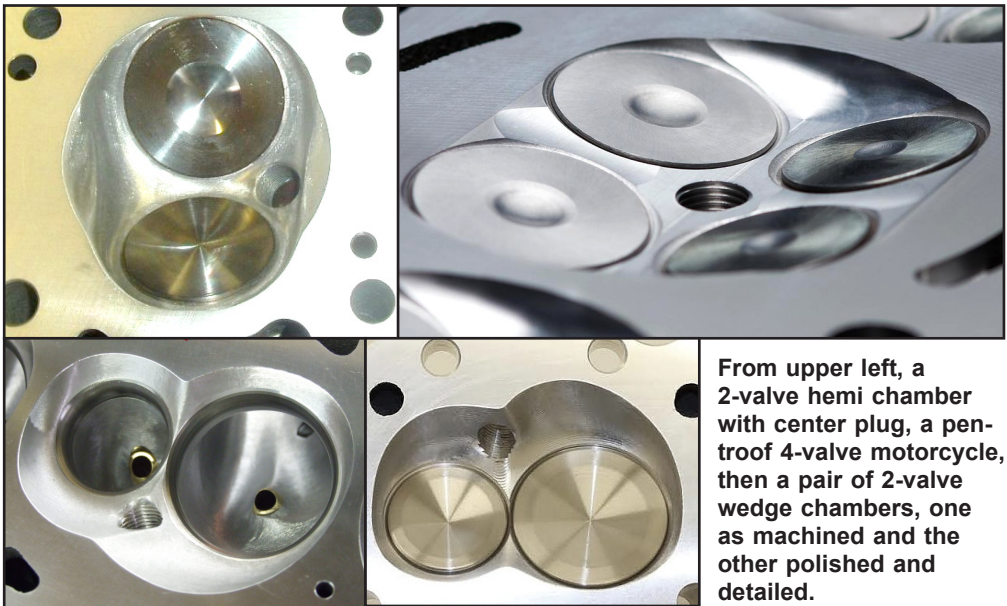

Combustion Category

increases, or if non-optimum air/fuel ratios are used, greater ignition lead (more time) will be required to efficiently burn the fuel and produce optimum power. This minimum timing requirement for optimum power at a specific operating condition is often called **MBT** (or **Minimum ignition advance for Best Torque**). An engine does not have single **MBT**, but rather many **MBTs** as engine speed, temperature, AF Ratio, fuel chemistry and other real-world factors change.

Ignition Timing

Optimum power production depends on the precise timing of the “ignition point,” an event that, as described above, can vary substantially. There is a significant delay in the initiation of measurable combustion after the *SparkPoint*, and even beyond that, many factors affect lag and the rate of combustion. So, what shall we call the actual point of ignition? Should it be: **1)** when the spark occurs, or **2)** when the fuel starts burning, or **3)** when pressure begins to rise in the cylinder? Rather than debating this, we will use other terms that have more precise meanings.

To begin, let’s establish the beginning of the *Combustion Cycle* at the **SparkPoint**, commonly know as the **Ignition Timing Point** of the engine. This will be the precise point, in crank degrees before top-dead center (BTDC), when the initiation of spark occurs. After the *SparkPoint* there is a delay before the pressure within the cylinder actually increases. This delay can be exaggerated when the piston begins to move down the bore after TDC, increasing combustion-space volume. At some point, however, the increasing volume is overcome by the rapid rise in temperature from expanding combustion. The first indication of a pressure increase is usually defined as the **Start Of Combustion**, even though it’s obvious that the combustion process was already underway, but remained in a low-burn-rate initiation phase.

We mentioned that the *Ignition-Timing* requirement for optimum power is com-

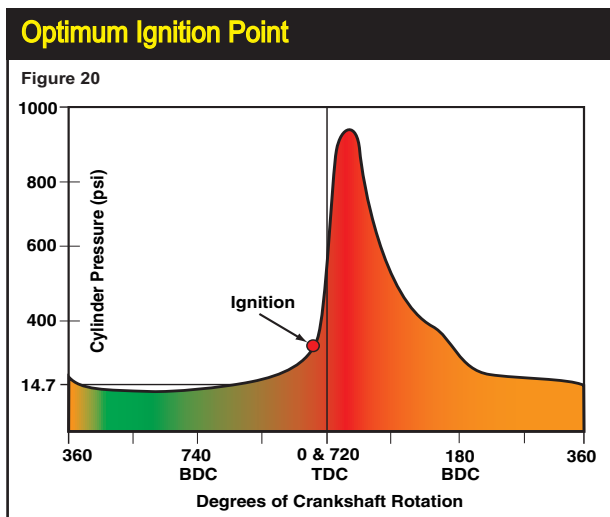

While an instantaneous fuel burn that produce peak pressures at the optimum crank angle is not possible, in general, the faster the pressure rises in the cylinder the more power the engine will produce. Modern combustion chamber designs are optimized for high turbulence and flame speeds within the constraints of preventing pre-ignition and detonation.

Combustion Category

Manual Advance Curve With Speed Limit

Ignition Timing (Spark Timing)

Basic Ignition Timing @ Crank: **24.0 Deg** BTDC
Timing Advance (Mechanical): **2.2 Deg** Per 1000 RPM
Until: **6500 rpm**

Estimate Ignition Timing (For Best Torque @ Each RPM Point)

Activate a manual, rpm-based advance curve by un-checking “Estimate Timing...” and specifying the initial-timing advance and the number of degrees for each 1000-rpm increase in engine speed. You can cap the advance curve by specifying a limit rpm.

monly called the **MBT** (Minimum advance for Best Torque). But this timing requirement changes as turbulence in the combustion chamber changes, since the burn rate is substantially linked to, among other things, the turbulence of the gasses in the combustion chamber. Furthermore, turbulence also changes when: **1)** Engine speed changes, **2)** Air/Fuel ratio changes, and **3)** When engine load (throttle position) changes. And, as mentioned, there are additional subtle changes to burn rate from charge temperature changes, differences in compression ratio, and even bore size and stroke length.

How can we take all these factors into consideration and determine the **MBT** for all engine speeds? The simulation performs these complex calculations and derives an estimate of an *Optimum Ignition* advance curve. To activate this feature, simply check the **Estimate Ignition Timing** checkbox in the Combustion Category (selected by default). You can view the calculated ignition timing values in the *ProData Table*, and on the top-right RPM graph.

If you would like to enter a specific ignition timing value and/or an advance curve based on engine speed, that option is also available. Un-check the **Estimate Ignition Timing** box, and enter values for **Basic Ignition Timing (BTDC)**. This is the SparkPoint relative to TDC measured in crank degrees. In addition, you can direct the simulation to calculate an advance curve by specifying the number of degrees of advance for each 1000-rpm increase in engine speed. You can “flatten”

Manual and MBT Advance Curves

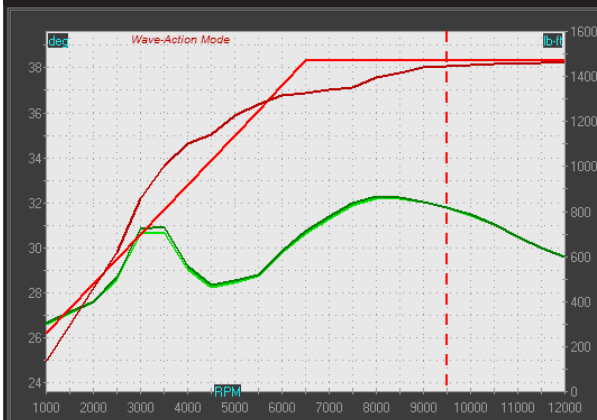

The advance curve (set in the Manual Advance Curve dialog shown above and illustrated in this graph by the light red line) started at 24-degrees advance, increased 2.2 degrees up to a limit at 6500rpm. The dark red curve is the MBT advance curve calculated by the simulation.

Combustion Category

the advance curve by specifying a limit rpm, after which no further advance is applied. After defining your own ignition values, you can quickly compare your curve with the *MBT* determined by the simulation; simply re-check the *Estimate Ignition Timing* box and note the changes in the advance curve and engine power.

Note: Overall engine design, including chamber geometry, fuel type and quality, and other factors, can produce variations in optimum ignition timing and advance curve requirements. In addition, a 3D model of the combustion space and a full analysis of flame travel (beyond the capabilities of this simulation) are required to fully simulate the ignition timing requirements, especially a high-performance or race engine. Use the ignition timing features available in Dynomation to help you establish baseline timing requirements. Actual dyno testing under real-world conditions is the only way to precisely determine an optimum ignition timing curve.

Combustion Category

Exhaust Category

THE EXHAUST SYSTEM CATEGORY Unique Models Are Used In The FE and WA Simulations, Both Are Detailed In This Chapter

The **EXHAUST** category establishes a mathematical model for the exhaust system of the simulated engine. Dynomation6 incorporates two distinct simulation methods, and each of these methods uses its own exhaust modeling technique. The *Filling-And-Emptying* simulation (used in DynoSim6) uses a simplified exhaust model, on the other hand, the *Wave-Action* method performs a much more rigorous mathematical analysis of exhaust pressure waves and, as a result, requires more detailed data inputs to complete a simulation.

An overview of *Filling-And-Emptying* menu selections is provided below. *Wave-Action* exhaust data entry is covered in the next section.

IMPORTANT NOTE ABOUT ALL HEADER CHOICES: Some engines can derive scavenging benefits from suction waves created in the collector by adjacent cylinders (although studies have revealed that the benefits, when they exist, are relatively small). The “one-cylinder-scavenges-another” is not modeled in this simulation. Instead, the headers are assumed to deliver a scavenging wave only to the cylinder that generated the initial and any subsequent pressure pulses.

Filling-And-Emptying (FE) Exhaust Selections

While the simplified *Filling-And-Emptying* exhaust method cannot not resolve exact header dimensions (approximations of lengths and sizes are calculated and

The WA and FE Exhaust Category

Exhaust

Filling/Emptying Exhaust Model: Large Optimized Stepped Headers, Open

Suggested FE Exhaust Dimensions FE Exhaust Tune RPM: 10500

Primary Runner Length: 25.000 in	Collector Pipe Length: 13.700 in	
Primary Pipe Diameter: 2.520 in	Collector Pipe Diameter: 4.500 in	

Wave-Action Exhaust Runner/Header Configuration:

Header Design: Primary Pipes W/Collector (4-to-1 type)

Min Port Area (per Valve): 3.50 sqin Primary Pipes Per Cylinder: 1

Primary Pipe	Secondary/First Step	Tertiary/Second Step
Length: 30.000 in	Length: <input type="text" value=""/>	Length: <input type="text" value=""/>
Inlet Dia: 2.750 in	Inlet Dia: <input type="text" value=""/>	Inlet Dia: <input type="text" value=""/>
Exit Dia: 2.750 in	Exit Dia: <input type="text" value=""/>	Exit Dia: <input type="text" value=""/>
Taper Angle: 0.0 Deg	Taper Angle: <input type="text" value=""/> Deg	Taper Angle: <input type="text" value=""/> Deg
Collector One	Collector Two/Step	Megaphone
Length: 16.000 in	Length: <input type="text" value=""/>	Length: <input type="text" value=""/>
Inlet Dia: 4.000 in	Inlet Dia: <input type="text" value=""/>	Inlet Dia: <input type="text" value=""/>
Exit Dia: 4.000 in	Exit Dia: <input type="text" value=""/>	End Dia: <input type="text" value=""/>
Taper Angle: 0.0 Deg	Taper Angle: <input type="text" value=""/> Deg	Taper Angle: <input type="text" value=""/> Deg

Pre-Collector Pipe Length: 30.000 in Total Collector Length: 16.000 in

Header Length (End to End): 46.000 in Exhaust Waves Stability:

The Exhaust System Category establishes the exhaust modeling for the FE Simulation (on the top, within the red box) while the Wave-Action Simulation choices take up the lower part of the Exhaust category. The FE selections are made from a two menus, consisting of 15 Model choices and one Tuning Speed selection. The WA exhaust selections are more detailed and allow hundreds of pipe, junction, and taper possibilities. When the WA simulation is used, the FE Exhaust choices are dimmed and vice-versa. However, when the *Hybrid Simulation Mode* is used, the exhaust systems of both simulations are available for input.

Exhaust Category—FE (DynoSim) Model

Filling-And-Emptying Exhaust System Menu

Stock Manifolds	Mufflers With/Cat
H.P. Manifolds	Mufflers With/Cat
H.P. Manifolds	Mufflers Without/Cat
Small-Tube Headers	Mufflers With/Cat
Small-Tube Headers	Mufflers Without/Cat
Small Headers	Open Collector
Small Headers, Flow Optimized, Race Design	Open Collector
Small Tri-Y Headers	Open Collector
Large-Tube Headers	Mufflers With/Cat
Large-Tube Headers	Mufflers Without/Cat
Large Headers	Open Collector
Large Headers, Flow Optimized, Race Design	Open Collector
Large Tri-Y Headers	Open Collector
Large Stepped-Tube Headers	Open Collector
✓ Large Stepped-Tube, Flow Optimized, Race Headers	Open Collector

The simulation contains different exhaust-system models for the *Filling-And-Emptying* and *Wave-Action* simulations. The *Filling-And-Emptying* selections (shown here) are “generic” models of various exhaust manifolds and headers, both with and without mufflers and catalytic converters.

shown in the FE exhaust group), it can predict engine power changes from various discrete selections of exhaust manifolds and headers provided in the *Filling/Emptying Exhaust Model* menu.

Each of the exhaust system selections apply a unique tuning model to the simulation. The menu includes fifteen selections, seven of which include mufflers, four include mufflers and catalytic converters, the remaining selections use “open collector” systems. When any of these exhaust configurations are used, the simulation will calculate and display an estimate of tubing diameters and lengths:

Stock Manifolds And Mufflers W/Cat

The first choice in the *Exhaust Model* menu simulates the most restrictive exhaust system; a “log-type” design, where all ports connect at nearly right angles to a common passage. This exhaust-modeling selection assumes that

The first choice in the *Filling-And-Emptying Exhaust Model* menu simulates typical, production, cast-iron, “log-type” exhaust manifolds, where all ports connect at nearly right angles to a common “log” passage. These manifolds are designed to provide clearance for various chassis and engine components and provide less than optimum exhaust flow.

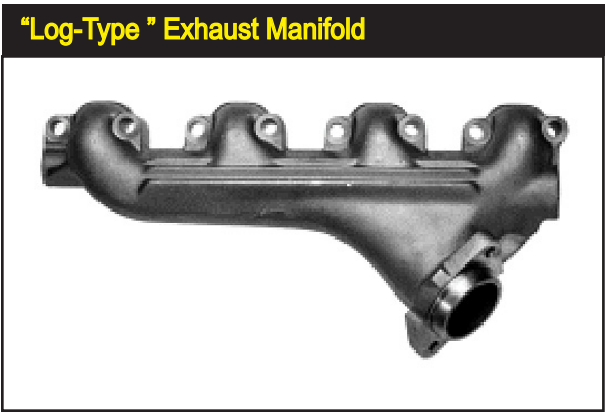

Exhaust Category—FE (DynoSim) Model

HP Manifolds And Mufflers



The *HP Manifolds And Mufflers* exhaust-system choices offer a measurable improvement over the stock-exhaust selection. High-performance exhaust manifolds are designed to improve exhaust gas flow and reduce system restriction. They are usually a “ram-horn” or other “sweeping” design with fewer sharp turns and larger internal passages, like this manifold for the Eclipse/Laser. The connecting pipes to the mufflers are large diameter and the mufflers generate less back pressure.

the manifolds are connected to typical OEM mufflers and catalytic converters with short sections of pipe. The exhaust manifolds and mufflers cancel all scavenging effects, and back pressure levels in the exhaust system effectively cancel blowdown effects of early EVO timing and increase pumping work losses during the exhaust cycle.

H.P. Manifolds And Mufflers W/Cat and WO/Cat

These choices offers significant improvements over the stock exhaust system discussed previously. The high-performance exhaust manifolds modeled are designed to improve exhaust gas flow and reduce system restriction. They are usually a “ram-horn” or other low-restrictive designs. While this system is considered a “high-performance” design, it offers little tuning effects and virtually all suction waves are fully damped. This exhaust system may allow some benefits from early-EVO timing blowdown effects.

Custom HP “Manifolds”



Here is an excellent example of a high-performance “manifold” replacement from Edelbrock for the Ford Focus. When used with mufflers, model this system using the *Filling-And-Emptying H.P. Manifolds And Mufflers Model* selection. When used without mufflers, select *Small Headers Open Exhaust*.

Exhaust Category—FE (DynoSim) Model

Original Max-Wedge Exhaust



Here is another example of factory high-performance cast-iron exhaust manifolds. These were developed by Chrysler in the 1960's for their Max-Wedge Program. You would not believe how heavy these manifolds were! It's also hard to believe that today they sell to collectors for more than \$2000 a set!

Small Tube Headers, Mufflers W/Cat and WO/Cat

This is the first exhaust-system model that begins to harness the tuning potential of wave dynamics in the exhaust system. Suction waves are created in the collector, but are somewhat damped by the attached muffler and catalytic converter, if used.

Small-Tube Headers, Open Exhaust

This choice simulates headers with primary tubes individually connecting each exhaust port to a common collector or tube. No mufflers are used. Strong suction waves provide a substantial boost to cylinder filling and exhaust gas outflow. These headers show the greatest benefits on smaller displacement engines.

Small-Tube Headers



This is the first exhaust-system selection that begins to harness the tuning potential of wave dynamics in the exhaust system. This tubular exhaust system from S&S for Honda engines offers wave-dynamic scavenging.

Large-Tube Headers



Large-tube headers mirror the capabilities of their small-tube counterparts, but their reduced restriction boosts performance on larger displacement engines.

Exhaust Category—FE (DynoSim) Model

Small-Tube Headers, Flow Optimized, Race Design

This choice simulates headers with large, sweeping curves, top-quality welding and construction. This professional design produces strong suction waves provide a substantial boost to cylinder filling and exhaust gas outflow. Backpressure is minimized. These headers show the greatest benefits on higher-rpm, smaller displacement engines.

Small Tri-Y Headers, Open Exhaust

This choice simulates open headers with separate primary and secondary tubes that converge to a common collector. This design creates strong suction waves over a wide rpm range that aids cylinder filling and exhaust gas outflow. These headers show the greatest benefits on smaller displacement engines.

Large-Tube FE Selections

These choices are functionally the same as the Small-Tube equivalents, but are constructed of larger, lower-restriction tubing. Primary tubes individually connect each exhaust port to a common collector. Suction waves are created in the collector, and if the collectors open to the atmosphere, these headers can show significant benefits on high-rpm or on supercharged engines. These headers may not increase power as much on small-displacement engines or when operating in lower-rpm ranges.

Large-Tube “Stepped” Selections

The “stepped” design of the primary tubes reduces pumping work on some engines. As high-pressure compression waves leave the port and encounter a step in the tube diameter, they return short-duration rarefaction waves. These low-pressure “pulses” assist the outflow of exhaust gasses by returning to the open exhaust valve(s) and assisting cylinder depressurization and reducing



Large-tube Stepped headers have large-diameter primary tubes with one or more transitions to larger tubing diameters. These “steps” can reduce pumping work and improve horsepower on high-rpm engines.

Exhaust Category—FE (DynoSim) Model

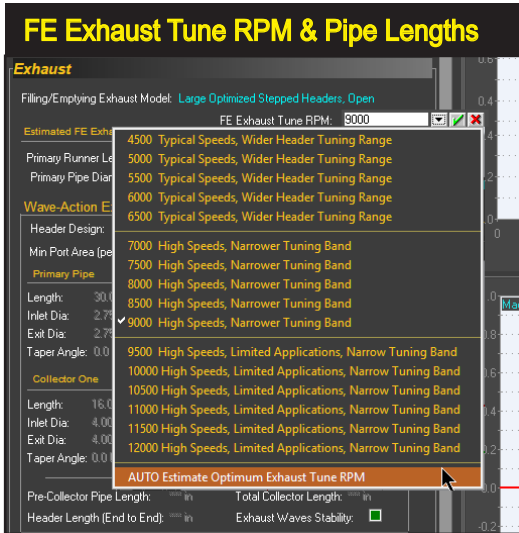

The FE Exhaust Category includes an input for *Tune RPM* that establishes the engine speed at which the exhaust system reaches peak tune (the rpm value is also used to estimate pipe lengths and diameters). You can also select *AUTO Estimate...* at the bottom of the menu that will automatically run a series of simulations and pick a (near) optimum selection for *Tune RPM*.

pumping work. This can generate a measurable increase in horsepower on large displacement and/or high-rpm engines.

Filling-And-Emptying Tune RPM

The FE Exhaust Category includes an input for *Tune RPM* that applies to all (FE only) header-based exhaust systems (excludes the first three manifold choices in the Exhaust menu, since these are not sensitive to length and do not generate reflection waves that can be tuned). The rpm value you enter into this field establishes the engine speed at which the exhaust system reaches peak tune; this is speed at which the exhaust pressure waves return the strongest reflection (suction) wave back to the cylinder to assist exhaust scavenging. This scavenging process assists exhaust gas outflow and improves intake inflow by lowering cylinder pressures.

Since the characteristics of exhaust pressure waves are pre-calculated in the FE simulation (making the FE model much faster and reduces the number of user inputs), the values entered in the *Tune RPM* on high-performance engines may have a more pronounced effect on power than the same pipe length changes in the Wave-Action simulation. Despite this, the FE can accurately predict engine power when the *Tune RPM* is set at an appropriate value for the current engine configuration (not tuned too far outside the “natural” peak-power point of the engine).

Wave-Action Simulation Note: The WA simulation used in Dynomation6 does not pre-calculate exhaust (or any other) pressures. Instead, the model continuously determines the effects of current exhaust pipe lengths, sizes, etc., by analyzing the evolving pressure waves as they progress through all the intake and exhaust passages of the engine.

Here are a few things to keep in mind when using *Tune RPM* in your simula-

Exhaust Category—Wave-Action Model

tions:

On engines with peak speeds of less than 6500rpm, no special considerations are required when selecting exhaust *Tune RPM*.

On engines built with an intended power peak of 6500rpm or greater, setting the *Tune RPM* to a low value (like 4500rpm) may over-predict low-speed torque. Avoid *Tune RPM* values that produce unusually shaped horsepower peaks on high output (and high-rpm) racing engines (like ProStock, motorcycles, etc.). Setting the *Tune RPM* value to generate a more typically-shaped power peak will produce the most accurate results.

Use the **Auto Estimate FE Exhaust Tune RPM** feature included in the *Tune RPM* menu. In many cases, it will find the best pipe length and tuning point within about +/-1000rpm.

Note: To run the FE *Auto Estimate* feature, the engine must be complete and have successfully run at least one simulation.

Wave-Action (WA) Exhaust Menu Selections

The following section covers the extended exhaust tuning used in the Dynomation6 Wave-Action simulation (does not apply to the FE simulation used in DynoSim6).

The exhaust system—perhaps more than any other single part of the IC engine—is a virtual “playground” for high-pressure wave dynamics. The interactions of these complex waveforms require a sophisticated simulation techniques to fully describe the physics of these high energy waves (called finite pressure waves). While the *Filling-And-Emptying* simulation determines pressure wave characteristics and then applies these pressure signatures to the simulation, the *Wave-Action* method performs a much more rigorous mathematical analysis. The WA sim constructs mathematical representations of the pressure waves as they are created and continues to “follow” their progress (updating the wave shapes, intensities and interactions) through all exhaust passages and junctions as the simulation runs through the 720 crank degrees

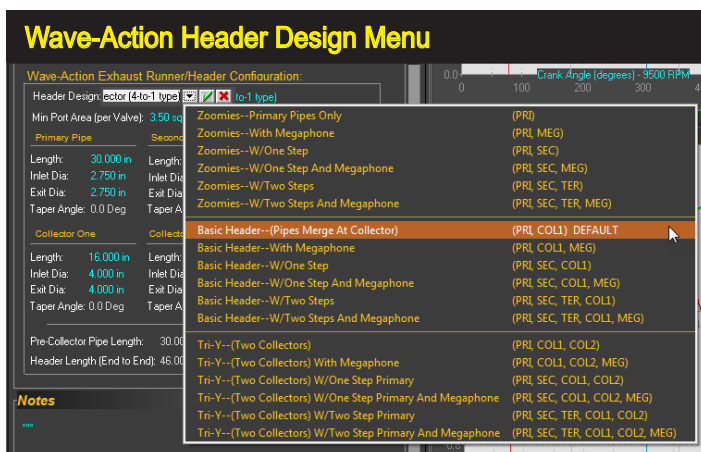

The Wave-Action *Header Design* menu provides 18 “basic” system configurations of pipes and junctions. Each menu choice activates the specific elements used to build that header configuration. From these basic types, you can construct almost about any possible exhaust header.

Exhaust Category—Wave-Action Model

Wave-Action Exhaust Elements

Dynomation6 Exhaust Elements

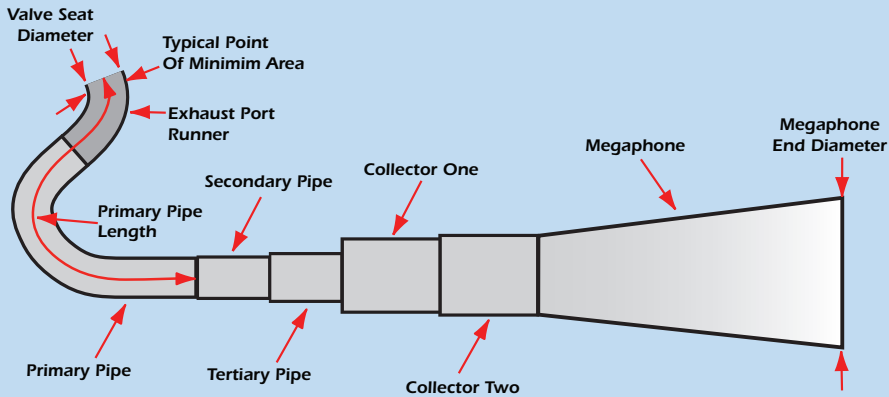

The Dynomation6 *Header Design* menu offers a “palette” of components that you can use to build virtually any header design. This drawing shows all elements arranged in order. Dynomation will only activate the elements necessary to build the header configuration you select. Choose from single pipe (Zoomies—as used on funny-cars and top-fuel dragsters) to complex headers with multiple collectors that merge pipe segments of increasing diameters (Tri-Y designs). Each element is actually modeled as an individual pipe segment, so except for name and dimensions, *Pipe*, *Collector*, and *Megaphone* are handled in a very similar ways by the WA simulation.

of the four-cycle process. This analysis is repeated at each rpm point throughout the engine test (requiring billions of calculations!). The *Wave-Action* model, and its ability to precisely recreate and display port pressures and velocities, can help you pinpoint optimum exhaust-system designs and dimensions.

Note: The *Wave-Action* model is designed to simulate open-exhaust systems without mufflers; however, you can introduce a restriction into the exhaust system by reducing the size of the *Minimum Exhaust Port Area* that can simulate a known exhaust system backpressure. Also, consider using the *Filling-And-Emptying* model to simulate the effects of mufflers, catalytic converters, etc.

Header Design

The **Wave-Action Header Design** menu established the basic pipe-junction model for the exhaust system. Eighteen model selections are available in from the menu:

Basic Exhaust/Header Configuration

Individual--Primary Pipes Only
Individual--With Megaphone
Individual--W/One Step

Active Elements Used

PRI
PRI, MEG
PRI, SEC

Exhaust Category—Wave-Action Model

Individual--W/One Step And Megaphone	PRI, SEC, MEG
Individual--W/Two Steps	PRI, SEC, TER
Individual--W/Two Steps And Megaphone	PRI, SEC, TER, MEG
Basic Header--(Pipes Merge At Collector)	PRI, COL1
Basic Header--With Megaphone	PRI, COL1, MEG
Basic Header--W/One Step	PRI, SEC, COL1
Basic Header--W/One Step And Megaphone	PRI, SEC, COL1, MEG
Basic Header--W/Two Steps	PRI, SEC, TER, COL1
Basic Header--W/Two Steps And Megaphone	PRI, SEC, TER, COL1, MEG
Tri-Y--(Two Collectors)	PRI, COL1, COL2
Tri-Y--(Two Collectors) With Megaphone	PRI, COL1, COL2, MEG
Tri-Y--(Two Collectors) W/One Step Primary	PRI, SEC, COL1, COL2
Tri-Y--(Two Collectors) W/One Step Primary & Megaphone	PRI, SEC, COL1, COL2, MEG
Tri-Y--(Two Collectors) W/Two Step Primary	PRI, SEC, TER, COL1, COL2
Tri-Y--(Two Collectors) W/Two Step Primary & Megaphone	PRI, SEC, TER, COL1, COL2, MEG

PRI: **Primary Pipe** always begins at exhaust port at the cylinderhead

SEC: **Secondary Pipe** always begins at end of the PRI pipe

TER: **Tertiary Pipe** always begins at end of the SEC pipe

COL1: **First Collector** always begins at end of the PRI, SEC, or TER pipe and can join/merge multiple pipes

COL2: **Second Collector** always begins at end of COL1 and can join/merge multiple collectors

MEG: **Megaphone** is always last element in the header system

Minimum Exhaust Port Area

This is the exhaust port area at the point of greatest restriction. It is usually located just above the valve seat near the valve guide (similar to the Intake Port Minimum Area). If the engine being modeled has multiple-valves per port, enter the area for a single (each valve) port branch; don't add the minimum areas of multiple port branches.

Pipes Per Cylinder

The *Wave-Action* model can simulate exhaust systems that use two exhaust pipes per cylinder, a design sometimes used on high-output engines also equipped with two exhaust valves per cylinder (Rotax, Honda, and other specialized high-output engines). In all other cases where one exhaust pipe is attached to the port outlet of each cylinder, this data field should be set to **1 (one)**.

Primary, Secondary, and Tertiary Pipe Lengths, Inlet Diameters, And Exit Diameters

The **Primary Pipe Length** is the distance from the exhaust port minimum-area location to the end of that pipe segment. The **Secondary** and **Tertiary** pipe lengths begin at the end of the previous pipe and terminate at the next junction or at the atmosphere. The **Pipe Inlet Diameters** are the inside diameter of the pipe at the point of connection to the cylinder head or a previous

Exhaust Category—Wave-Action Model

Wave-Action 4-to-1 Header Model

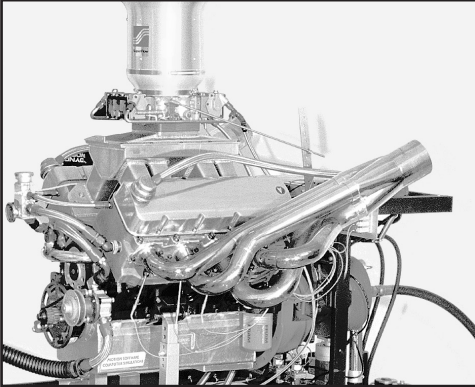

The Dynomation6 *Wave-Action* model can simulate typical 4-to-1 automotive headers with the default *Header Design* selection: *Basic Header—(Pipes Merge At Collector)*. This will activate the *Primary Pipe* and *Collector One* elements. The model will “join” the exit of the primary pipe(s) to the inlet of the collector.

pipe. When the inlet diameter is larger than the previous pipe exit diameter, a **Step** is created that will generate a rarefaction wave. **Pipe Exit Diameters** are either the same size as the *Inlet Diameter* (for a simple tube) or is larger when modeling a *tapered pipe segment*. If the inlet and exit diameters are different, the simulation models the pipe segment using a perfect taper and displays the **Taper Angle** used in the calculation.

Primary and Secondary Collector Lengths, Inlet Diameters, And Exit Diameters

The **Collector Length** begins at the end of the previous pipe or collector and terminates at the next junction or at the atmosphere. The **Collector Inlet Diameters** are the inside diameter of the pipe at the point of connection to the previous pipe(s). When the inlet diameter is larger than each of the previous pipe(s) exit diameter, a **Step** is created that will generate a rarefaction wave. **Collector Exit Diameters** are either the same size as the *Inlet Diameter* (for a straight collector) or is larger or smaller when modeling a *tapered collector*. If the inlet and exit diameters are different, the simulation models the pipe segment using a perfect taper and displays the **Taper Angle** used in the calculation.

Megaphone Length And Exit Diameter

This is the **Length** and **Exit Diameter** of the Megaphone. *Note that the inlet of the Megaphone is always set to the exit diameter of the previous pipe segment (you cannot create a Step at the entrance of a megaphone)*. By entering an *Exit Diameter* larger than the *Inlet Diameter*, the simulation will model the megaphone using a perfect taper and display the **Taper Angle** used in the calculation.

Note: Only the Wave-Action exhaust elements currently in use (not dimmed) are active, based on the current selection from the **Header Design** menu. When you switch to a different Header Design, Dynomation will remember cur-

Exhaust Category—Wave-Action Model

The key to determining where the Primary Pipe ends and the Collector(s) begin is to locate the point of greatest area change within the header. This is where the strongest rarefaction waves are generated. On this header, the area change is the greatest at approximately the middle of the merge sections of the collectors.

Measuring Exhaust Tubing Lengths

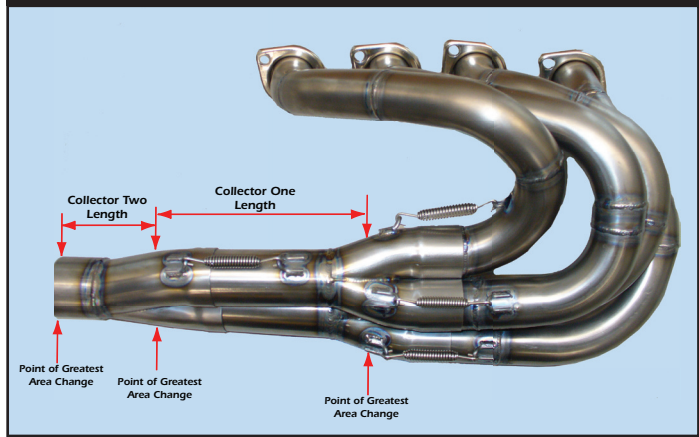

rent pipe specifications (even those not used in the new model just selected), so if you switch back to a previous model, the values you entered are still available in most cases.

Real-World Examples Of WA Exhaust Header Modeling

Dynomation6 Wave-Action exhaust modeling offers a “palette” of components that you can use to build virtually any header design in just minutes. Start by selecting the basic configuration that matches your overall design from the **Header Design** menu in the Exhaust Category. Next, enter the dimensions for the elements that are active in your design (not dimmed). When complete, the simulation will run and use the system model you have defined. Let’s build a couple of real-world exhaust models to illustrate this process.

A “Standard” 4-into-1 Header

We’ll start out with a typical 4-to-1 header, where four cylinders (or four of eight cylinders in a V8 engine) are merged together using a collector.

Note: The term “collector” and “collector extension” are sometimes confused or have unique meanings in different parts of the world. To be consistent in Dynomation, the term **collector** will refer to the pipe that “collects” the outflow of other pipes and merges them into a single flow stream (usually of larger cross-sectional area). The length of the collector is the length of this merge area PLUS the length of remainder of the collector pipe that, at its end, opens to the atmosphere. The term “extension,” if used in this context, will mean any slip-on/removable pipe used to extend the overall length of the collector (modeled by adding a 2nd collector with the same entrance and exit diameter).

Exhaust Category—Wave-Action Model

To activate the elements needed for the “standard” header, first make sure that the WA Simulation is active by clicking the **Wave Action Model** radio button in the Simulation Category. Then select **Basic Header—(Pipes Merge At Collector)** from the **WA Header Design** menu in the Exhaust Category.

The exhaust component menus will activate the **PRI** (Primary Pipe) and the **COL1** (Collector One) groups. Enter the primary tube length by clicking on the “***” or the current value displayed in the *Primary Tube Length:* field. You can select a value from the menu or you can directly enter any value within the limits of the program (shown in the Status Bar at the bottom of the program screen). Move to the *Inlet Dia:* field by either clicking on the field or (without using the mouse) press **Enter** to accept the *Length:* and automatically jump to *Inlet Dia:*. Press **Enter** again to open that field, enter a value, then continue pressing **Enter** to move through the remaining fields. When all data for the Primary Pipe and Collector One groups has been entered, the Exhaust Category will be complete (providing you have also entered a value in the *Minimum Exhaust Port Area* and *Pipes Per Cylinder* fields, as described earlier in this section).

NOTE ABOUT EXHAUST TUBING LENGTHS: As far as simulation is concerned, the lengths of the various elements of the exhaust system are determined by the location of the greatest area transition between one element and the next. This is where the strongest rarefaction wave is returned to the exhaust valve to assist exhaust-gas outflow.

When measuring the ending point between a primary and secondary pipe, the point of transition is easy to see; it’s the junction of the two elements. However, the functional transition between merging pipes and a collector is not as clear. When a pressure pulse reaches a collector junction, the simulation “sees” the strongest evidence of the junction when the outgoing pressure pulse reaches the area of greatest change between the pipe and collector. However, depending on the interior shape of the collector (where the primary pipes end within the collector, whether the pipes have transition “cones,” etc.), it may oc-

Wave-Action Stepped-Header Modeling



These custom Tri-Y headers have stepped Primary pipes that increase in diameter about 8-inches from the port flange. The larger tubes then merge into two first collectors (*Collector One*) which then merge into a second collector (*Collector Two*) which finally terminates at the atmosphere.

Exhaust Category

Determining Transition Points In Pipes



When you measure pipe lengths for simulation, the *start* and *end* points from one pipe to the next occur half-way through a transition, such as these tapered collectors from *Cone Engineering* (manufactures header pipes and accessories).

cur closer to the multiple-pipe merge entrance or closer to the straight portion of the collector. If you are in doubt about the exact location of a transition, use the center of the merge span of the pipes into the collector.

Add A “Step” To The Primary Pipe

If you would like to model a step in the Primary Pipe before the Collector, select **Basic Header—W/One Step** from the **WA Header Design** menu. This will activate the *Secondary Pipe* group. Since the Step is a transition from one pipe size to a larger diameter, the Step acts as the beginning of a Secondary element in the exhaust system.

Enter the **Length:**, **Inlet Dia:** and **Exit Dia:** values for the Secondary Pipe. Note that you may have adjust the Primary Pipe length if you wish to keep the overall length of tubing at an optimum length for the application (the **Pre-Collector Pipe Length:** is displayed at the bottom of the Exhaust Category).

A Tri-Y Header With Two Steps

Finally, let's consider a more complex model: a Tri-Y header (with two collectors) and a primary section incorporating two steps (modeling Primary, Secondary, and Tertiary pipe sections). Select **Tri-Y—(Two Collectors) W/Two Step Primary** from the **WA Header Design** menu.

This menu choice will activate the **PRI, SEC, TER** pipes (Primary, Secondary and Tertiary Pipes) and the **COL1, COL2** (Collector One and Two) groups. Enter in the Primary, Secondary, and Tertiary pipe data as before. Keep in mind that all of these lengths combine to make up the total pipe length before the first collector. Then enter Collector One and Collector Two data, with the first Collector **Length:** based on the information in the note **ABOUT EXHAUST TUBING LENGTHS** presented earlier in this section. Typically, these distances are measured from the middle of the first merge section to the middle of the second merge section and the Second Collector length measured from the middle of the second merge section to the end of the open pipe at the atmosphere.

Exhaust Category

Wave-Action Filling & Emptying Simulations ^{Version} 6

SIMULATION RESULTS

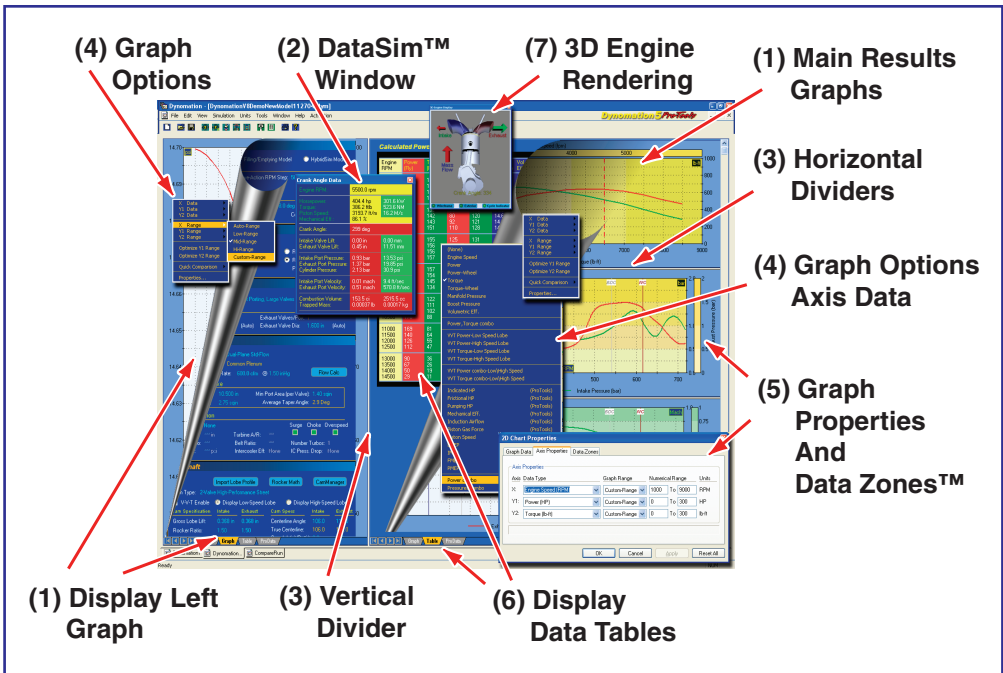

Applies To FE and WA Simulations
Except as Indicated

The **Simulation Results** graph, table and other data displays are designed to help you retrieve the most information from any simulation. Each of the numbered areas shown above are described below:

- 1) Main Results Graphs**—The main program screen is divided into two main sections (the left and right panes), with the component-selection categories on the left and the main results graphs/tables on the right. The *Wave-Action* and *Filling-And-Emptying* simulations display engine performance (horsepower and torque, by default) in the top-right results graph. The simulation also analyzes and displays intake, exhaust, and cylinder pressures and port-flow velocities

Simulation Results Displays

All results graphs can display a red-dotted reticule line to indicate specific points within the data being displayed. For example, the top horsepower graph reticule line indicates a specific engine speed, while the center and lower graphs point to a crank-angle (for Wave-Action simulations only). To “activate” any of these reticule lines, simply click on the graph.

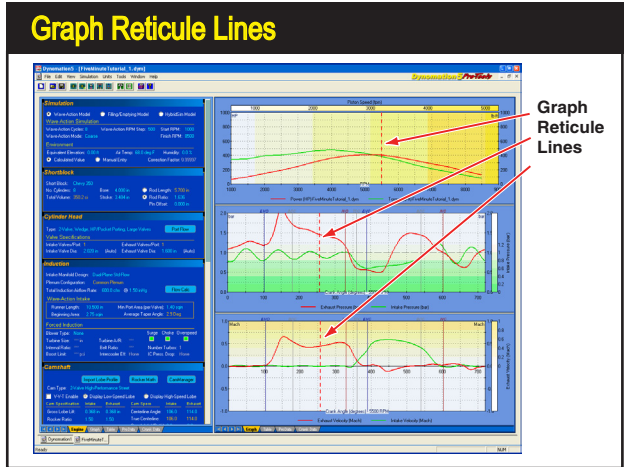

which are presented in the in the center and lower crank-angle-based graphs (and in the graph located under the Component Categories activated using the **Display Data Tabs** [#6] in the photo on the left). For more information on how to interpret port pressure and flow graphs, refer to **Wave-Dynamics Analysis** (later in this manual).

Graph Reticule Lines

All results graphs can display a red-dotted reticule line to indicate specific points in the data being displayed. For example, the top horsepower graph reticule line indicates a specific *engine speed*, while the center and lower graphs point to a *crank-angle* (for Wave-Action simulations only). To “activate” any of these reticule lines, simply click on the graph. To use the reticule lines, first drag the reticule on the top horsepower graph to set an rpm point. Next, click on either

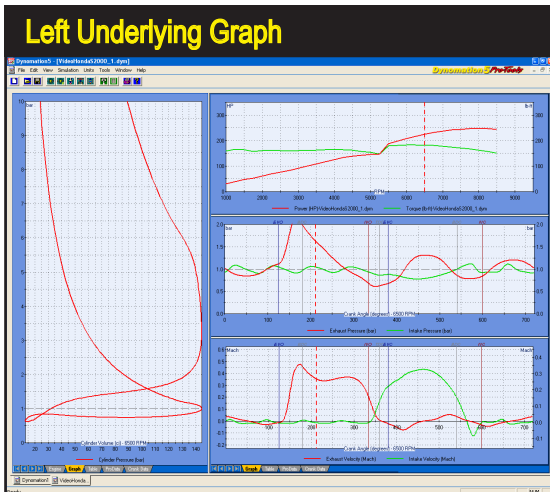

In addition to the three graphs displayed on the right side of the main program screen, a fourth graph is available by clicking on the **Graph** tab located at the bottom of the Component Category pane (left Pane). This graph shows Cylinder-Pressure vs. Cylinder-Volume by default (commonly known as a P-V diagram), however, you can re-assign any crank-angle based data to either the Y1 or Y2 graph axis and either crank-angle or cylinder-volume to the X axis.

Simulation Results Displays

the center or lower graph to set a specific crank angle. The exact values “under” these reticules is displayed in the *Crank-Angle DataSim™* window (see #2, below).

Graph Underlying Component Categories

In addition to the three graphs on the right pane of the Main Program Screen, an additional graph is available by clicking on the **Graph** tab located at the bottom of the left pane. This graph, like the center and lower graphs on the right pane, is based a “crank-angle” display. The graph typically displays *Cylinder Pressure* in bar (1bar = atmospheric pressure) vs. *Cylinder Volume*, often called a **P-V**, or pressure-volume graph.

Note-1: For more information about interpreting P-V diagrams, see *Pressure-Wave Dynamics*, later in this manual.

Note-2: The center, lower, and graph under the component categories display data curves when: **1)** A simulation has been completed, and **2)** The top *Horsepower/Torque* graph reticule line has been activated (by clicking on the graph) to set a specific rpm point for which the crank-angle data is displayed.

- 2) **DataSim™ Window**—The exact values “under” the reticule lines on all graphs are displayed in the *Crank-Angle DataSim™* window. Open this floating display by clicking the **DataSim™ Icon** on the Main Program **Toolbar** or by selecting **Crank-Angle DataSim™ Window** from the **Tools** drop-down menu. Moving the reticule line on the (top-right) rpm-based graph and/or any crank-angle based graph will update all *DataSim™* fields. You can step forward and backwards through crank-angle data one-degree at a time by first clicking on any crank-

The exact values “under” reticule lines are displayed in the *DataSim™* window (also, see illustration, next page). Open this helpful tool by clicking the *DataSim™ Icon* on the Main Program **Toolbar** or by selecting *Crank-Angle DataSim™ Window* from the **Tools** drop-down menu. You can step forward or backwards through crank-angle data one-degree at a time by first selecting a graph (just click on it), then press either the right or left arrow keys. Hold the **SHIFT** key to increase steps to 10-degrees per keypress.

DataSim™ Window		
Crank Angle & RPM Simulation Data		
Engine RPM:	5500.0 rpm	
Horsepower:	729.2 hp	543.8 kW
Torque:	696.4 ftlb	944.1 NM
Piston Speed:	3895.8 ft/m	19.8 M/s
Mechanical Eff.:	79.2 %	
Crank Angle:	0 deg	
Intake Valve Lift:	0.00000 in	0.0000 mm
Exhaust Valve Lift:	0.00000 in	0.0000 mm
Intake Port Pressure:	0.722 bar	10.47 psi
Exhaust Port Pressure:	1.213 bar	17.59 psi
Cylinder Pressure:	53.200 bar	771.6 psi
Intake Port Velocity:	0.000 mach	0.0 ft/sec
Exhaust Port Velocity:	0.000 mach	0.0 ft/sec
Combustion Volume:	6.008 ci	98.45 cc
Trapped Mass:	0.003644 lb	1.6528 g

Simulation Results Displays

Simulation Crank-Angle Data Displays

Wave-Action Simulation Port Pressures And Velocities

(2) Crank-Angle Data-Sim™ Window

Crank Angle & RPM Simulation Data		
Engine RPM	5500.0 rpm	
Horsepower	728.2 hp	543.8 kW
Torque	636.4 lbs	944.1 NM
Valve Speed	3895.8 ft/m	19.8 M/s
Mechanical Eff.	79.2 %	
Crank Angle	0 deg	
Intake Valve Lift	0.00000 in	0.0000 mm
Exhaust Valve Lift	0.00000 in	0.0000 mm
Intake Port Pressure	0.722 bar	10.47 psi
Exhaust Port Pressure	1.213 bar	17.59 psi
Cylinder Pressure	53.200 bar	771.6 psi
Intake Port Velocity	0.000 mach	0.0 ft/sec
Exhaust Port Velocity	0.000 mach	0.0 ft/sec
Combustion Volume	6.008 ci	98.45 cc
Trapped Mass	0.003644 lb	1.6528 g

Data Values "Under" Dotted Reticule Lines

(1) Crank-Angle Data Displays

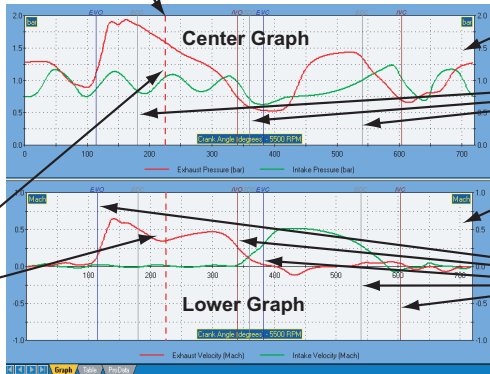

(3) Port Pressures

(4) TDC/BDC Piston Position Indicators

(5) Port Velocities

(6) Valve-Event Timing Indicator Lines

The simulation Crank-Angle Data Displays (1) reveal an entire spectrum of pressures and flow velocities for the simulated engine. The crank-angle *Port Pressures* graph (3) displays intake, exhaust, and (optionally) cylinder pressures and other data. *Port Gas Velocities* for intake and exhaust flow are shown by default in the lower graph (5). Exact values of displayed data are shown in the *Crank-Angle DataSim™* window (2). Simply position the *Dotted Reticule Line* over the data you wish to examine. The *Crank-Angle* graphs also have indicator lines for valve-event timing (6) and piston position (4). Studying these pressure curves can help locate inefficiencies and diagnose tuning problems (for more information about how to interpret the port pressure and flow graphs, refer to *Wave-Dynamics Analysis* later in this manual).

Any of the four screen-pane dividers can be moved to allow specific data displays more screen "real estate."

You can drag the vertical divider to the left or right and move any horizontal graph dividers to the top and bottom to show graphs at any size you wish.

Moveable Screen Pane Dividers

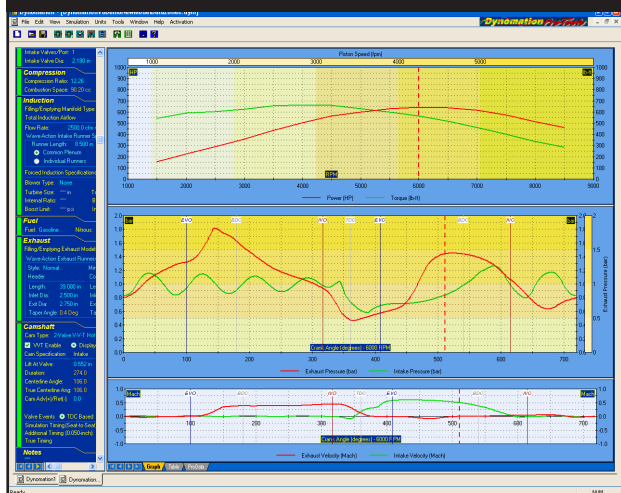

Simulation Results Displays

angle graph (to select it), then pressing either the right or left arrow keys. Holding **SHIFT** key will increase the cursor key steps to 10-degrees.

- 3) Vertical And Horizontal Screen Dividers**—The center divider between the left and right panes and the horizontal dividers between the right-pane graphs can be moved (click and drag) to re-size any results display to suit your requirements. When any screen area has been adjusted, the graphs will redraw and re-scale to take advantage of changes in display area. Divider positions are not “remembered” from session to session (however, all other graph and display defaults are stored in the **.dxml** engine simulation file and will be reapplied the next time the engine file is opened).
- 4) Graph Options Menu**—Right click on any graph to open the *Graph Options Menu*. This menu provides fast access to custom graph settings, including data displayed, axis scaling, establishing side-by-side comparisons, and more:

Axis Data

The first three choices from the *Graph Options Menu* allow you to customise the data displayed on each of the three graph axis (Horizontal **X** Axis, Left Vertical **Y1**, and Right Vertical **Y2**; see photo on next page). Each of these axis can be assigned a variety of simulation results (the exact selection varies depending on whether the **X** Axis is *rpm*, *crank-angle* or *cylinder-volume*). Some the data-set choices are: Indicated, Frictional, Pumping, and Brake Horsepower, Wheel Horsepower, Torque, Volumetric Efficiency, a variety of Pressures (Imep, Fmep, Pmep, Bmep, Manifold, Boost), velocities (Intake and Exhaust Port Flow), Intake and Exhaust Valve Lifts, CD's and Curtain Areas, Cylinder Volume, Mechanical Efficiency, Induction Airflow, Gas Force On The Piston and more.

Axis Scaling

The second group in the *Graph Options Menu* allows you to select several methods of axis scaling. You will notice that each axis can be scaled to a

Right-click any graph to show the *Graph Options* menu. Use the *Data* choices to assign any simulation data set to any axis you desire (within the graph family of either *rpm-based*, or *crank-angle* based data). The *Range* choices provide a variety of fixed and auto-scaling options for each axis. Use the *Optimize Yx Range* selections to quickly set optimum (fixed) scaling for any currently displayed data. For even more options, choose *Properties* to open the *Graph Properties Dialog* box.

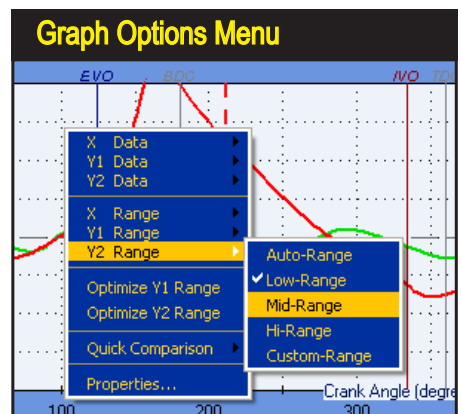

Simulation Results Displays

Results graph consists of two vertical axis, a left and right. Either of these axis can be quickly set for optimum viewing using the *Optimize Y1* (left axis) or *Optimize Y2* (right axis) choices (lower graph on right is *Optimized* display of exactly the same data). Optimize choices apply *Fixed-Axis* scaling (axis will not re-scale automatically). To reset the graph back to normal scaling, select one of the *Range* options, or select *Properties* from the bottom of the *Options* Menu and click *Reset All*.

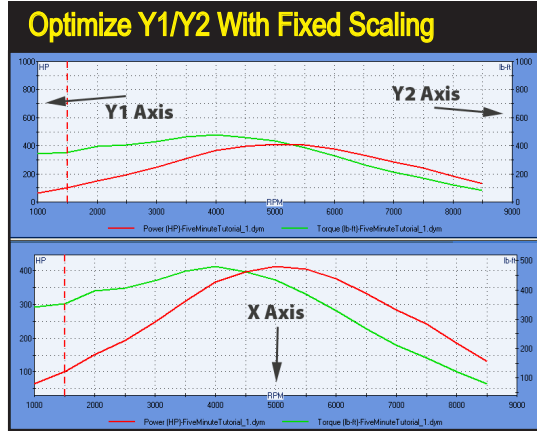

fixed *low*, *medium*, and *high* value. In addition, an auto-scaling feature can be enabled for any axis (turned off, by default). Use any fixed-axis scaling to maintain constant axis values. This establishes a “fixed visual baseline,” making it easy to see changes in power or torque as engine specifications are modified (graph won’t rescale). However, when component changes dramatically alter data, use the auto-scaling feature will ensure that the entire data set is always visible and shown at 80 to 90% of full graph height for good resolution.

Optimize Y1(Left) / Y2(Right) Ranges

The *Graph Options Menu* includes two *Optimize Y1/Y2 Range* selections that quickly establish optimum viewing using *Fixed Axis Values* (axis will not re-scale automatically after it has been set). To reset the graph back to normal range scaling, select one of the *Range* options described in the previous paragraph, or select *Properties* from the bottom of the *Options* menu and click *Reset All* to restore the display (only on the selected graph) to default values.

The *Graph Options Menu* also contains a *QuickCompare™* feature that instantly establishes any engine as a “baseline,” allowing easy-to-see changes in engine performance from that point onward.

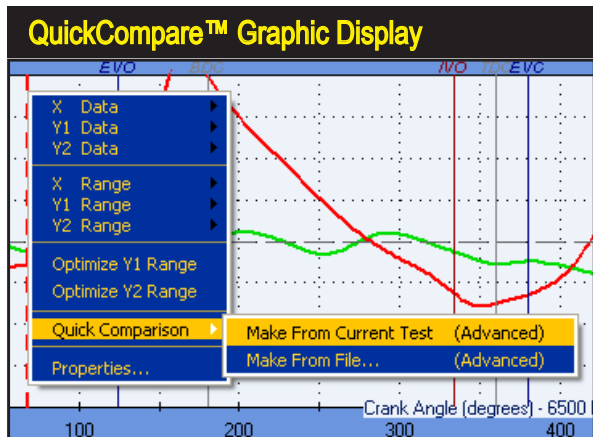

Simulation Results Displays

This comparison of three engines was setup using the **Graph Options Properties Dialog**. Up to four “open” engines can be compared on any graph. This graph shows how horsepower and torque varied on all three test engines.

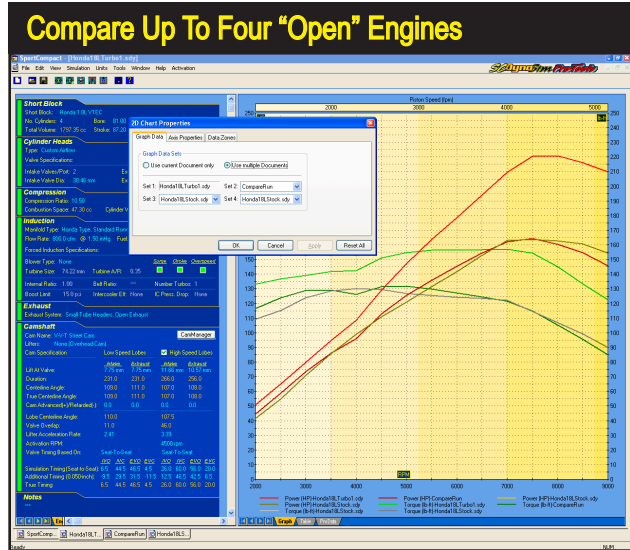

5) **Graph Properties Dialog**—This dialog contains three tabbed pages that provide detailed control of the current graph. Here is an overview of each tab:

Graph Data: Using the drop-down lists on this page you can quickly establish on-graph comparisons with up to three additional different engines. The engines you wish to include on the current graph must be “open,” with active **Selection Tabs** at the bottom of the **Main Program Screen**. First, make sure the **Use Multiple Documents** radio button is selected (allows multiple data sets). Next, select the specific engine you wish to add using the **Graph Data Sets** drop-down menus. Up to three additional engines can be selected using **Set 2**, **Set 3** and **Set 4** menus. When you click **Apply** or **OK**, the current graph will redraw and include the desired engine-data comparisons. Legends at the bottom of the graphs will provide keys to all graphic curves.

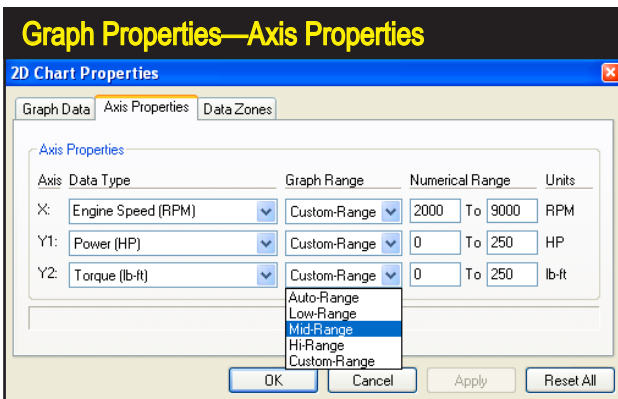

Change the data and display characteristics of the current graph by modifying the **Data Type**, **Graph Range**, and **Numerical Range** using the **Axis Properties** tabbed page

Simulation Results Displays

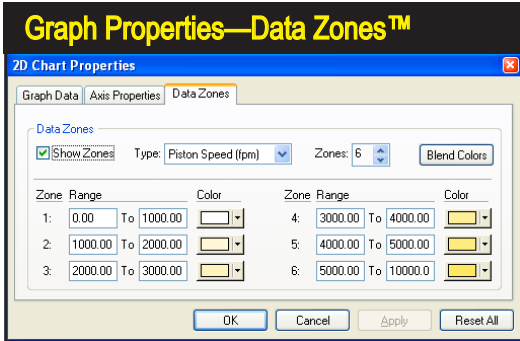

DataZones™ extend the graphic-display and data-analysis capabilities of the simulation. Using this feature, you can display additional engine data, show ranges, or clearly label dangerously high pressures, engine speeds, and more.

Axis Properties shows the current **Data Types** and **Ranges** for the current graph. Modify any characteristic by changing properties. Create custom numeric ranges by selecting **Custom-Range** from the bottom of any of the drop-down **Range** menus).

DataZones™ Displays: **DataZones™** extend the graphic-display and data-analysis capabilities of the simulation. Using this feature, you can display additional engine data and/or show ranges for target power values or label dangerously high pressures, engine speeds, and more. To setup a **DataZone**, first select the data that you would like to display from the **Type** drop-down menu. Next, select the number of **DataZones** you would like to display by clicking on the “up” or “down” arrows next to the **Zones** field. You can modify the **Range** values and **Colors** for each zone (to have the simulation build a uniform transition between these colors for intermediate zones, set a starting and ending colors then press **Blend Colors**). Click

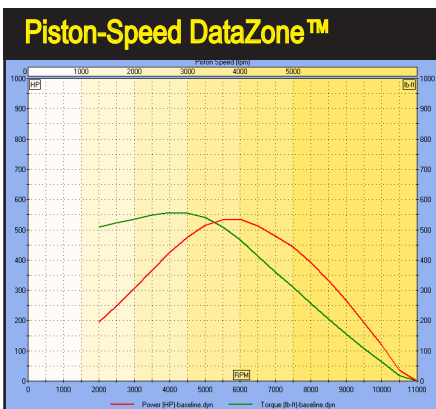

This **DataZone** display shows Piston-Speed bands drawn on the standard HP/Torque graph. The range values are indicated at the top of the graph.

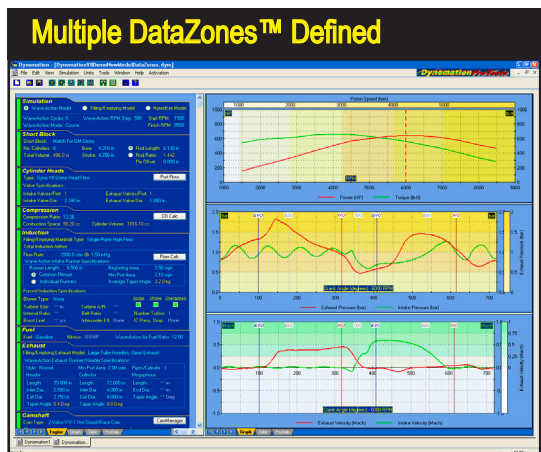

DataZones™ can be defined for any of the four graphs available in the simulation. **DataZone** setups are saved with .dxml engine files.

Simulation Results Displays

In addition to extensive graphing capability, the simulation offers several chart displays that can be viewed by clicking any *Table*, *ProData*, or *Crank Data* tab located at the bottom of either the left or right pane. The tables list engine variables recorded during the simulated dyno run. In this illustration, exact simulation results are displayed in 500rpm increments from 2000 to 11,000rpm.

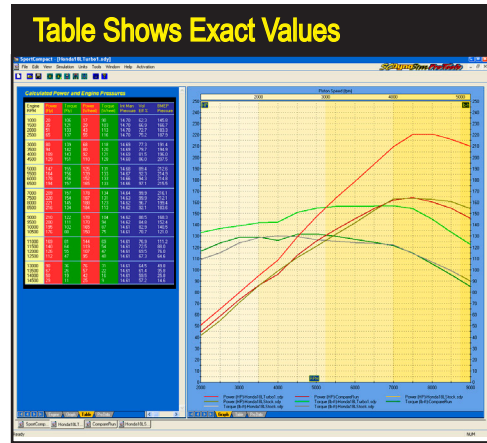

on **Apply** or **OK** to draw the specified zones on the main graphic display. **Note:** *DataZone* variables can only be selected if they are the same as, or directly derived from, one of the variables currently displayed on the graph. In other words, it has to “make sense” to display that data set on the current axis. For example, you can display *Piston Speed DataZones* on standard Horsepower/Torque graphs since *Piston Speed* is directly calculated from engine rpm, but *Manifold Pressure* cannot be displayed, since it is not directly calculated from (and its units are not related to) engine rpm, power, or torque, the three main data sets displayed on the standard Horsepower/Torque graph.

Reset All is available at the bottom of the *Graph Properties Dialog* that lets you reset the current graph back to default settings, including the default axis data, scaling, etc. (this full reset applies only to the selected graph).

Engine-Pressures, Rpm-Based Data Table

Engine RPM	Power (Ft)	Indicated Power	Frictional Power	Pumping Power	Mech. Eff %	Induction Airflow	Piston Force	Piston Speed	IMEP Pressure	FMEP Pressure	PMEP Pressure
2000	86	124	21	16	70.5	125.7	1535	1333	108.2	18.2	13.7
2500	130	176	28	16	74.9	180.4	1745	1667	122.9	19.9	11.0
3000	169	225	37	16	76.2	223.9	1853	2000	130.5	21.7	9.4
3500	229	295	47	16	78.4	308.4	2089	2333	147.2	23.6	8.1
4000	301	383	59	18	79.8	403.8	2370	2667	167.0	25.7	8.0
4500	377	477	72	23	80.1	502.3	2626	3000	185.0	28.0	8.9
5000	441	561	87	27	79.7	596.1	2776	3333	196.6	30.4	9.4
5500	486	626	104	30	78.7	680.3	2815	3667	198.4	32.9	9.4
6000	510	671	123	31	77.1	747.4	2768	4000	195.1	35.6	9.0
6500	521	704	143	32	75.1	810.0	2680	4333	188.8	38.5	8.5
7000	507	711	166	31	72.3	854.0	2513	4667	177.1	41.4	7.7
7500	490	719	192	30	69.2	888.6	2371	5000	167.1	44.6	6.9
8000	443	696	219	27	64.6	912.1	2152	5333	151.7	47.8	5.9
8500	405	685	250	25	59.9	932.1	1994	5667	140.5	51.3	5.1
9000	346	695	283	21	53.6	945.4	1802	6000	127.0	54.8	4.1
9500	271	611	319	17	45.1	938.7	1591	6333	112.1	58.5	3.0
10000	224	599	358	14	38.0	961.0	1482	6667	104.4	62.4	2.4
10500	131	541	400	8	24.6	951.9	1275	7000	89.8	66.4	1.3
11000	55	504	445	3	11.1	953.0	1134	7333	79.9	70.5	0.5

This is the *ProData™* table (display by clicking the *ProData* tab at the bottom of the left and right display panes). The table provides a detailed listing of engine pressures, piston speeds, gas forces, induction airflow, mass flow and more.

Simulation Results Displays

Crank-Angle Data Table

Calculated Crank Angle Data

Crank Angle	Intake Pressure (bar)	Exhaust Pressure (bar)	Cylinder Pressure (bar)	Trapped Mass (LB)	Intake Velocity Mach	Exhaust Velocity Mach	Cylinder Volume (CI)	In Valve Lift (IN)	Ex Valve Lift (IN)
0	0.99	0.98	30.14	0.00121	-0.00	0.02	13.02	0.000	0.000
5	0.99	0.96	52.23	0.00121	-0.00	0.02	13.23	0.000	0.000
10	0.99	0.94	77.51	0.00121	0.00	0.01	14.27	0.000	0.000
15	0.99	0.92	81.08	0.00121	0.00	0.01	15.46	0.000	0.000
20	1.00	0.91	72.03	0.00121	0.00	0.01	18.00	0.000	0.000
25	1.01	0.90	60.31	0.00121	0.00	0.00	20.83	0.000	0.000
30	1.01	0.90	49.08	0.00121	-0.00	-0.00	24.26	0.000	0.000
35	1.00	0.91	41.74	0.00121	-0.00	-0.01	27.35	0.000	0.000
40	0.99	0.92	33.09	0.00121	-0.00	-0.01	32.48	0.000	0.000
45	0.99	0.94	28.60	0.00121	-0.00	-0.01	36.19	0.000	0.000
50	0.99	0.97	23.30	0.00121	-0.00	-0.02	42.13	0.000	0.000
55	0.99	0.99	20.51	0.00121	0.00	-0.02	46.30	0.000	0.000
60	0.99	1.01	17.17	0.00121	0.00	-0.01	52.90	0.000	0.000
65	1.00	1.04	14.90	0.00121	0.00	-0.01	53.55	0.000	0.000
70	1.01	1.05	13.20	0.00121	0.00	-0.01	64.18	0.000	0.000
75	1.01	1.07	11.47	0.00121	-0.00	-0.01	71.22	0.000	0.000
80	1.00	1.08	10.51	0.00121	-0.00	-0.00	75.97	0.000	0.000
85	1.00	1.08	9.31	0.00121	-0.00	-0.00	83.13	0.000	0.000
90	0.99	1.08	8.48	0.00121	-0.00	0.00	83.02	0.000	0.000
95	0.99	1.08	7.81	0.00121	-0.00	0.00	94.70	0.000	0.000
100	0.99	1.07	7.35	0.00121	0.00	0.01	99.05	0.000	0.000

The simulation can also display a table of crank-angle-based pressures and other data derived at each 5-degrees of crank rotation throughout the 720-degrees of the four-cycle process.

- Exact-Value Table Displays**—The simulation also offers several tables of data generated during the simulation process. These exact-value resources are displayed by clicking the **Table**, **ProTable**, or **Crank Data** tabs located at the bottom of the left or right display panes. The **Table** and **ProTable** charts display engine variables recorded at the same step-rpm and range that was used during the simulation (set in the *Simulation Category* at the top of the main program screen). The **Crank Data** table shows a “snapshot” of crank-angle based data taken at each 5-degrees throughout the 4-stroke process. Scroll down the table to view the changes in flow at IVO; see reversion just before IVC, examine valve lift, cylinder pressures, and more.
- 3D-Engine Pressure/Flow Display**—A real-time, 3D-Engine rendering (avail-

The simulation includes a 3D-Engine rendered in real time that shows valve and piston positions synchronized with the reticules on the crank-angle graphs. Port pressures and velocities are indicated with shades of color and directional arrows. *Mass Flow* (into and out of the cylinder) is also indicated. This can be a very helpful tool to visualize gas dynamics and the otherwise-hidden characteristics of a running engine.

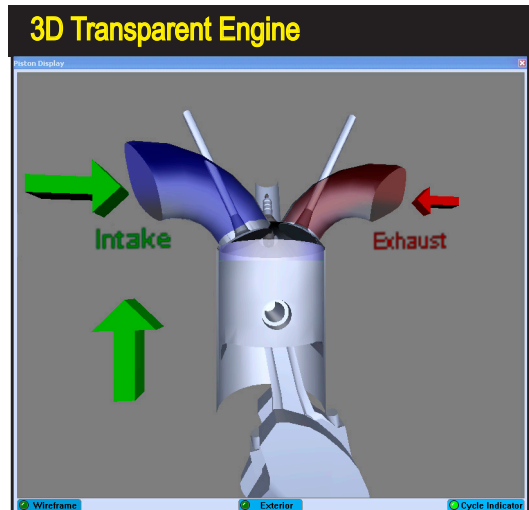

Simulation Results Displays

To activate the 3D Engine Display either click on the 3D Engine icon in the Toolbar or select **3D Engine Pressure/Flow Display...** from the **Tools** menu.

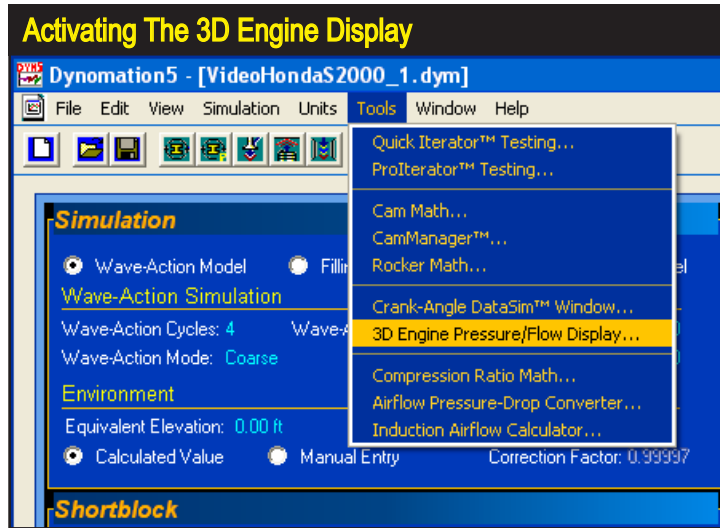

able for all simulation modes: *Filling & Emptying*, *Wave-Action*, and *HybridSim*) shows valve and piston positions synchronized with the reticule locations on the crank-angle graphs and with the data displayed in the **DataSim™** window. Port pressures and velocities are indicated with shades of color and directional arrows. You can also see a *Mass Flow* indicator (flow into and out of the cylinder). This display can be helpful in visualizing gas flow and otherwise-hidden characteristics of a running engine. For additional information about interpreting the data shown in the *3D Engine* display and the crank-angle graphs to which it is synchronized, refer to the *Wave Dynamics Analysis* chapter later in this manual.

Display the 3D Engine view by clicking the **3D Engine** icon in the **Toolbar**, or by selecting **3D Engine Pressure/Flow Display...** from the **Tools** menu. The main features of the 3D Engine display are shown in a nearby photo and described below:

- 1) Intake Port Color Intensity**—The intake port wall color varies from gray to a saturated blue. This color is directly linked to the measured pressures (wave intensities) within the intake port. Low pressures (expansion waves) produce a colorless gray, while a strong blue is generated when a high pressures (compression waves) reach the valve.
- 2) Exhaust Port Color Intensity**—The exhaust port wall color varies from gray to a saturated red. This color, similar to the intake port, is directly linked to the measured pressures (wave intensities) within the exhaust port. Low pressures (expansion waves) produce a colorless gray, while a red is generated when a high pressures (compression waves) reach the valve.
- 3) Intake Port Flow Arrow**—Flow velocity and direction within the intake port are indicated by this arrow. When the arrow is green and points

Simulation Results Displays

3D Engine Display Features

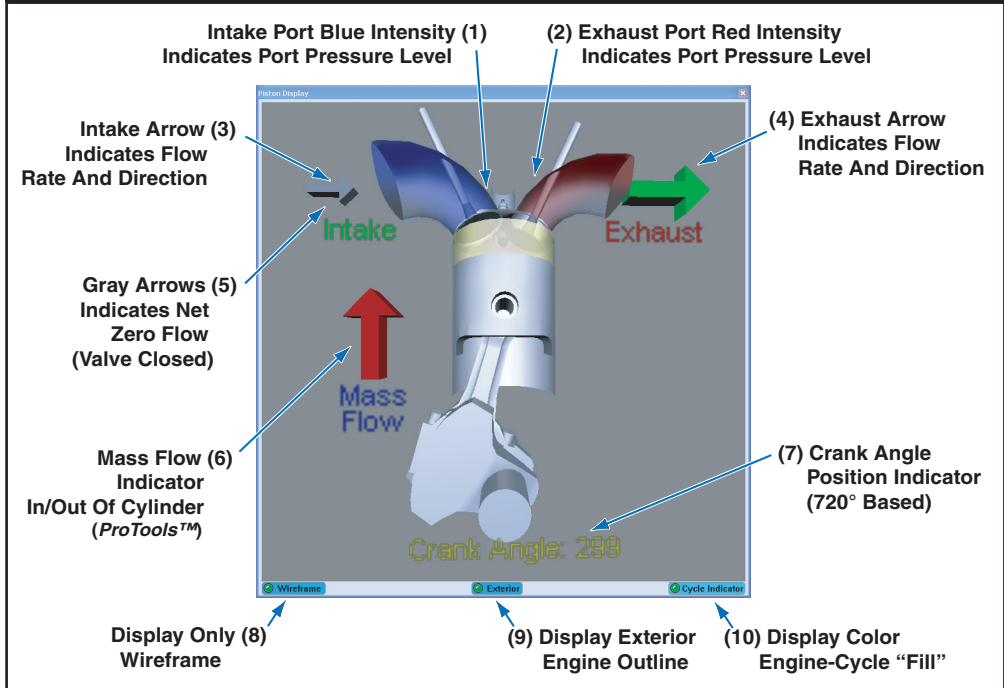

inward, toward the port, overall induction flow is moving toward the valve. The size of the arrow indicates the rate of flow. A red arrow pointing outward indicates reverse flow (reversion of charge back into the intake port). Also see **5, Gray Arrows**, below, for more information about arrow displays.

- 4) Exhaust Port Flow Arrow**—Flow velocity and direction within the exhaust ports is indicated by this arrow. Green arrows pointing outward indicates normal exhaust flow moving away from the valve. A Red arrow pointing inward, toward the valve, indicates reverse flow (reversion of exhaust gasses moving back into the cylinder). The size of the arrow indicates the flow rate. Also see **5, Gray Arrows**, below, for more information about arrow displays.
- 5) Gray Arrows**—When either the intake-port or exhaust-port arrow turns gray, this indicates that the valve within that port has closed, and net flow is zero. The arrow, however, may oscillate inward and outward as pressure pluses and particle velocity oscillates back and fourth in the port.
- 6) Cylinder Mass Flow Arrow**—This arrow indicates the changes in “trapped mass” within the cylinder; the size of the arrow indicates the mass rate of change. A green downward arrow indicates that mass is flowing into the cylinder (e.g., during the intake stroke), and a red up-

Simulation Results Displays

ward arrow indicates that cylinder mass is decreasing (e.g., during the exhaust stroke). The *Mass Flow Arrow* also can also identify induction reversion during overlap and just before IVC. When there is no change in cylinder mass (when both valves are closed), the *Mass Flow Arrow* is no longer displayed.

- 7) **Crank Position Indicator**—The rotational position of the crank is displayed using 720-degree notation. The zero position starts at TDC on the beginning of the power stroke. This corresponds to the crank-angle graphs on the right of the Main Program Screen.
- 8) **Display Only Wireframe**—If you wish to display the 3D Engine using only the underlying wireframe model, click this control (faster screen draw).
- 9) **Display Exterior Engine Outline**—This control toggles on and off a transparent image of the exterior dimensions of the engine.
- 10) **Display Color Engine Cycle**—This control toggles on and off the color fill for the cylinder that indicates the current engine cycle: Red indicates the power stroke; Yellow for the exhaust stroke; Green for the intake stroke; and Blue for the compression stroke.

Note-1: You can control the size, view, and position of the 3D Engine. To “grab” the engine, rotate it, and position it within the window, hold down the left mouse and drag. To enlarge and reduce the size of the 3D Engine, hold down the right mouse button and drag inward and outward.

Note-2: You can step forward and backwards through crank-angle data one-degree at a time by first clicking on any crank-angle graph (to select it), then either the right or left arrow keys. Holding **SHIFT** key will increase the cursor key steps to 10-degrees. The *3D Engine* display will remain synchronized to the current crank-angle reticule line as it moves with each keypress.

Wave-Action Version 6 Filling & Emptying Simulations

QUICK-ITERATOR™

The screenshot shows the 'Quick Iterator' software window. The interface includes a status bar at the top, a main control area with buttons for 'Best HP' and 'Best Torque' under two optimization sections ('Optimize Cam Timing' and 'Optimize Bore/Stroke'), and two graphs. The left graph is a 'Current Test' plot of Power (HP) vs. Engine Speed (RPM), showing three curves: Baseline (grey), Current (green), and Best (red). The right graph is an 'Iterator Best Result' bar chart comparing Baseline and Best results, showing a 5.8 hp increase. Labels with arrows point to various parts of the interface: 'Iterator Running Status' points to the status bar; 'Simulation Tests In Current Phase' points to the progress indicators; 'Current Results' points to the 'Current Test' graph; 'Best Results' points to the 'Iterator Best Result' graph; 'Quick Iterator™ Dual-Phase Status' points to the main window title; 'Find Optimum Cam Timing Group' points to the top optimization section; 'Windows Close Button' points to the window control buttons; 'Save Iterator Result' points to the 'Save' button; and 'Find Optimum Bore/Stroke Group' points to the bottom optimization section.

With the power and speed of simulation makes it possible to fill file cabinets with *simulated* dyno-test data. In fact, it's easy to become "bogged down" in an overabundance of data. Sorting through simulation results, analyzing the best power curves, and selecting promising component combinations can turn into a job nearly as difficult as the old trial-and-error dyno testing method!

One solution to this problem was introduced by Motion Software's as *Iterative Testing™* (pronounced "it-er-ah-tive" and "it-ter-a-tor"), a powerful feature available in both the FE and WA simulations. Iterative testing performs series of simulation calculations automatically until the final, optimum answer is obtained.

The simulation incorporates two versions of Iterative testing, **The Quick Iterator™** is extremely simple to use (refer to the next chapter for information on the advanced **ProTools™ ProIterator™**). By clicking a single button, the *Quick Iterator* will perform a test series to find optimum horsepower or torque. The *Quick Iterator*

Using The Quick Iterator™

Quick Iterator™ Generated Engines



When the *Quick Iterator* has completed its analysis, you can save the results (by clicking the Save button). The program will generate a new simulated engine with the component combination that produced optimum power or torque. The new engine will be added to the “open” engines included in the *Engine Selection Tabs* at the bottom of the *Main Program Screen*. *Quick-Iterator* engines can be analyzed, compared with other open engines, and modified in any way, just like any other engine in the simulation.

applies an optimization process called *Dual-Phase™ Testing* to find the best combination in short period of time. The first test phase uses a wide range of testing values. After the best result has been found from this wide-range search, a second phase is performed using a much narrower range of test values. The *Dual-Phase* approach allows the *Quick Iterator* to perform, for example, a search for optimum cam timing in less than 2500 simulation runs; typically, less than two minutes of processing time for the *Filling-And-Emptying* simulation and about 10 minutes for a *Wave-Action* simulation (on 4.0 Ghz or faster computer systems).

Using The Quick Iterator™

To perform a *Quick Iterator* analysis, select all the components for the baseline engine. Make sure all *Title Bars* in each Component Category are **dark-tone**, indicating that all engine components have been selected. There are two main testing groups in the *Quick Iterator* and two buttons in each group. The upper group searches for optimum cam timing for either peak horsepower or peak torque. The lower group determines the best bore and stroke combination (maintaining current engine displacement) for either optimum horsepower or peak torque.

Press either the **Best HP** or **Best Torque** button in the *Optimize Cam Timing* group to begin an analysis of valve-event timing that will optimize horsepower or torque within ± 500 rpm of the current power or torque peak. The *Quick Iterator* assumes that the current cam used the simulated engine is a “roughly” appropriate for the intended application and uses current cam timing as a starting point. You can follow the progress of the *Quick Iterator* by viewing the indicators in the *Iterator Status* group.

To perform an analysis of cylinder-bore and crankshaft-stroke dimensions, press

Using The *Quick Iterator*™

To pinpoint improvements located by the Iterator, you can setup back-to-back comparisons with the original, baseline engine. Right-click the graph, select *Properties*, then include the baseline engine as one of the *Data Sets*. The baseline engine curves will be drawn on the current graph, and the key-legend at the bottom of the graph will be updated to include the new comparison.

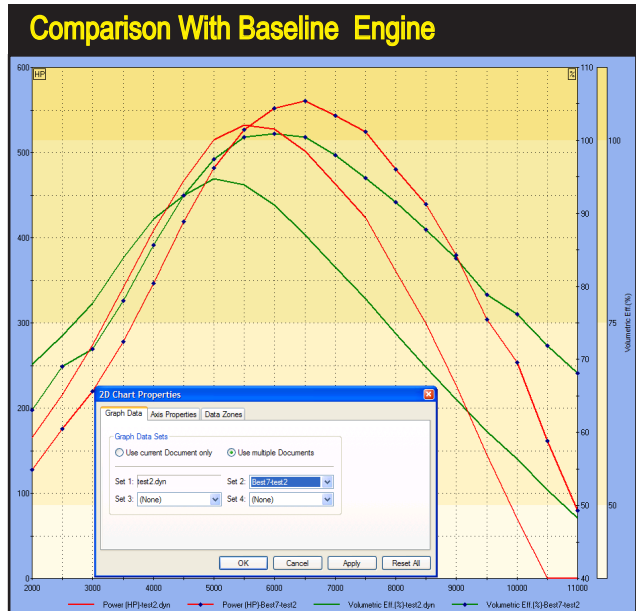

either the **Best HP** or **Best Torque** button in the lower group. The **Quick Iterator** will determine the best bore-and-stroke combination for optimum horsepower or torque within ± 500 rpm of the current horsepower or torque peak (current displacement will be maintained).

When *Iterative* testing is complete (you can stop testing at any time by pressing the **Stop** button; press **Resume** to continue testing), the **Iterator Best Result** graph will show the improvement in horsepower or torque found with the new component specifications. You can keep the results by clicking **Save**. In a few seconds, the simulation will create a new, simulated engine incorporating the component combination that produced optimum power or torque. Switch between the new engine and the baseline engine by using the **Engine Selection Tabs** at the bottom of the *Main Program Screen*. *Quick-Iterator* created engines can be analyzed, tested, and modified in any way, just like any other engine in the simulation. In fact, it is possible to use the result to begin a **new Iterator** test to further “home in” on the desired results.

The *Quick Iterator* will almost always find more power or torque. To pinpoint the improvements, setup a back-to-back comparison with the original, baseline engine. Simply right-click on the power/torque graph of the Iterator engine, select **Properties**, then include the baseline engine in one of the four **Data Sets** shown on the *Graph Data* page. The baseline engine curves will be included on the current graph, and the key-legend at the bottom of the graph will be updated.

Note: Whenever the *Quick Iterator* is used with **Variable Valve Timing** to find the best Horsepower or Torque, tests are only run on the High-Speed Lobe profiles. The low-speed lobes are not tested and remain unchanged. If peak

Using The *Quick Iterator*™

torque is generated by the low-speed cam and you wish to optimize torque using the low-speed profile, build a separate engine—without V-V-T—using the low-speed cam data. Then run a *Quick Iterator* on that engine model to find the best-torque, valve-event timing.

Wave-Action Filling & Emptying Simulations

Version **6**

PRO-ITERATOR™

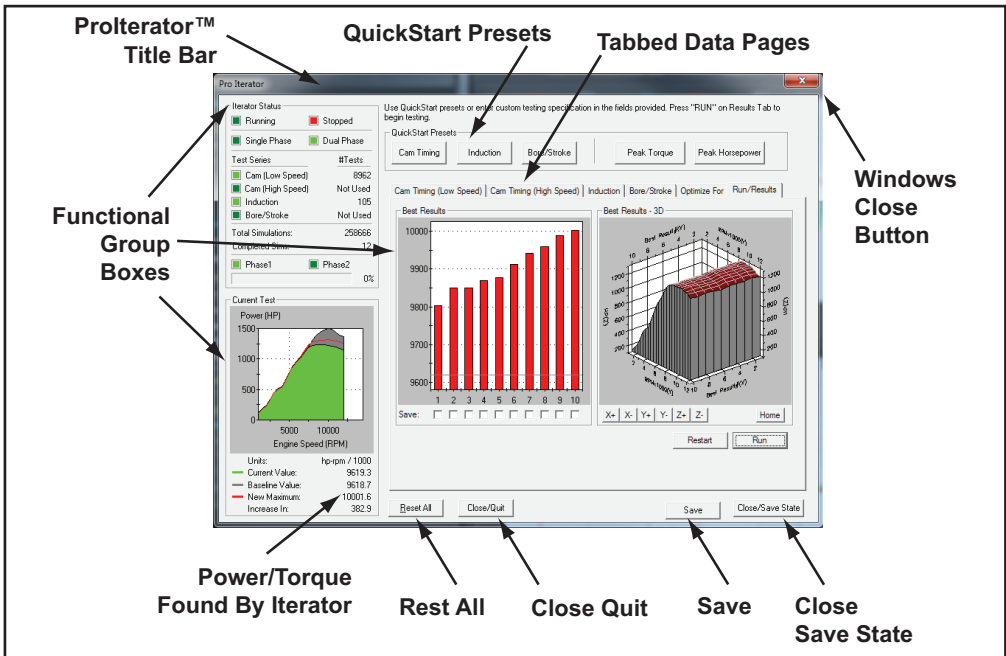

The **Pro-Iterator™** (pronounced "it-ter-a-tor" and "it-er-ah-tive testing") provides a powerful and easy-to-use tool for optimizing engine components. The serious engine designer needs the ability to perform Iterative testing on multiple engine systems, such as *Induction*, in the testing criterion. This, combined with greater flexibility in setting testing parameters, area-under-the-curve results analysis, variable power-band ranges, and more, is offered in the **Pro-Iterator™**.

Using The Pro-Iterator™

Open the **Pro-Iterator™** by choosing **Pro-Iterator™ Testing...** from the **Tools** menu or by clicking the **Pro-Iterator™ Icon** in the **Toolbar**. Tips on setting up the **Pro-Iterator** are provided in the **Walkthrough** later in this section.

The **Pro-Iterator** main screen consists of the following Groups:

Using The *ProIterator*™

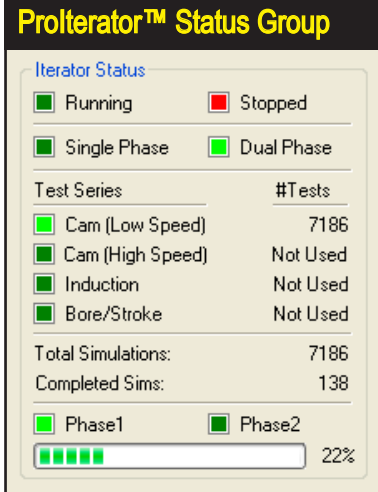

Indicators within the status group clearly show current testing progress. *Running* and *Stopped* are located directly above the *Single-* and *Dual-Phase*™ indicators; the *ProIterator*™ can use *Dual-Phase*™ optimization to find the best combinations in the shortest time. The *Test-Series* indicators show whether a particular engine component category will be included and modified in the test series.

Iterator Status Group (upper-left corner)

Indicators within this group show current testing status. The *Running* and *Stopped* “lights” are located directly above the *Single-* and *Dual-Phase*™ indicators. Like the *Quick Iterator* (discussed in the previous chapter), the *ProIterator*™ can use *Dual-Phase*™ optimization to find the best combinations in reduced time. The first phase tests over a wide range of values. After the best result is found, a second testing phase is performed using a narrower testing range. The *ProIterator*™ extends the dual-phase capability by allowing all variable “steps” to be fully customizable. *Dual-Phase*™ and standard *Single-Phase*™ testing can be toggled on and off as desired.

Below the phase indicators are *Test-Series* fields that show whether a particular engine component category will be included in the Iterator series. The three test groups, *Cam Timing* (for V-V-T cams: *High-Speed* and *Low-Speed* are available), *Induction*, and *Bore/Stroke* correspond to the similarly named tabbed pages in the center of the dialog box. A light-green indicator shows that this group will be included in the test series, and *# Tests* displays how many simulation cycles will be performed within this category. The total number of simulations is shown below, along with the number of completed test runs. At the bottom of the *Iterator Status* group are the *Phase 1* and *Phase 2* indicators (only visible when *Dual-Phase*™ testing has been enabled) and a progress bar that shows the progress of each phase in multi-phase testing.

Current Test Group (bottom-left corner)

The *Current Test* graph displays three horsepower or torque curves (and area-under-the-curve, if selected). The gray curve represents the initial, baseline power/torque; the green curve is the current Iterator cycle test result, and the red curve is the highest power discovered up to that point in the testing series. A key-legend is provided below the graph along with the exact values

Using The *ProIterator*™

The *Current Test* group displays three horsepower or torque curves: The gray curve represents the baseline, the green curve is the current test, and the red curve is the highest power/torque found. Exact values for the baseline, current, maximum, and gain-or-loss in power/torque are provided at the bottom of the *Current Test* box.

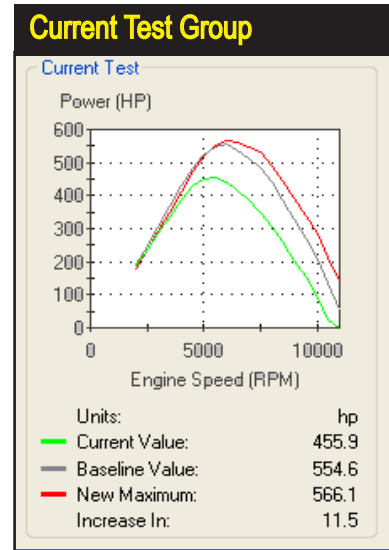

for the baseline, current, maximum, and gain-or-loss in power/torque.

QuickStart Presets Group (top center)

The convenience of one-button testing incorporated in the *Quick Iterator*™ is also a part of the *ProIterator*™. The *ProIterator*™ does not begin testing when a *QuickStart* button pressed. Instead, it loads a “typical” set of testing parameters into the appropriate tabbed data page (each tabbed data page is discussed next). For example, if you click the **Cam Timing** and **Peak Horsepower** presets, the **Cam-Timing Page** establishes a **Dual-Phase**™ cam-timing testing series based around the current camshaft and the **Optimize-For Page** selects **Peak Horsepower** as the principal search criterion. Use the **Reset All** button located at the bottom of the screen to clear all Presets and return the tabbed-pages to their default setup.

Tabbed Data Page Group (center of screen)

Six data-entry-and-display pages are available as tabbed screens at the center

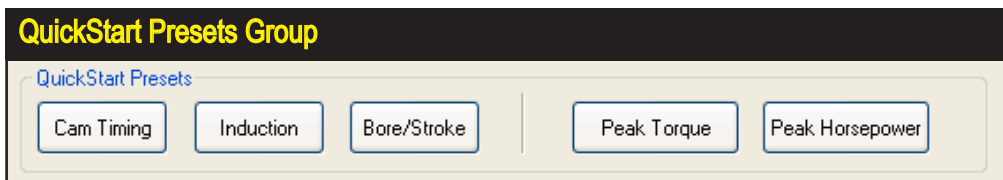

The convenience of one-button quick testing has been incorporated in the *ProIterator*™. Click any preset button (e.g., *Cam Timing* and *Peak Horsepower*) to establish a testing series on the appropriate tabbed data page. Use the **Reset All** button at the bottom of the dialog box to clear all Presets and return the tabbed-pages to their default setup.

Using The *ProIterator*TM

Camshaft-Timing “Tabbed” Data Pages

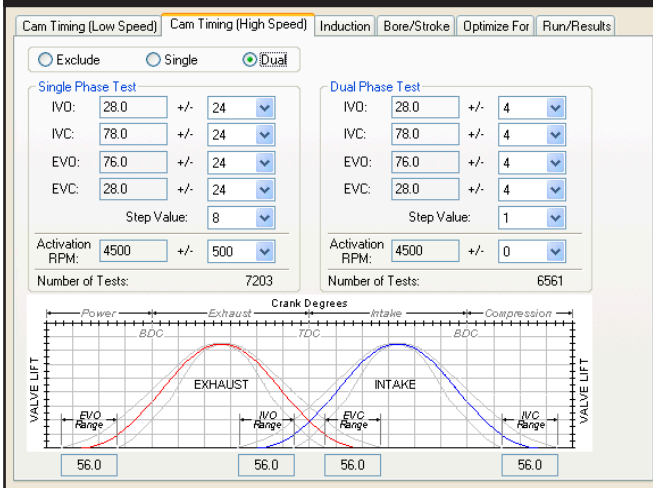

The *Cam Timing* tabbed pages establish a *Single- or Dual-Phase*TM test of cam-timing changes on power or torque output. Select either the *Single- or Dual-Phase* radio button and enter the testing criterion in the *Single- and/or Dual-Phase Test* boxes. The ranges of individual cam-timing values evaluated during *ProIterator*TM testing are displayed just below the “twin-hump” cam-timing diagram.

of the *ProIterator*TM.

Cam-Timing Tabbed Pages (Standard and Variable-Valve Timing)

The first two tabbed pages establish a *Single- or Dual-Phase*TM test of cam-timing changes on power or torque output. The *Low Speed* lobe is also used for standard, non-VVT (Variable Valve Timing) cams, while the *High-Speed* tab is only used for the high-speed lobe on VVT applications. You can quickly setup tests by clicking on the **Cam Timing** button in the *QuickStart Preset* group (described previously). This will perform a *Dual-Phase* test of 8,962 simulations that will take about 5 minutes for the FE model on 4Ghz and faster computers.

If you did not press one of the **Preset Buttons**, the *Cam-Timing Tabbed Pages* default to **Exclude** (perform no cam-timing tests) as shown by radio-button controls at the top-left of the pages. To setup cam-timing iteration, select either the **Single-** or **Dual-Phase** radio button and enter the testing criterion in the **Single-** and/or **Dual-Phase Test** boxes, located below the radio buttons. The number of degrees through which valve-timing events will be evaluated are shown just below the twin-hump cam-timing diagram.

Note: When performing iterative testing on **Variable Valve Timing** cams of the dual-lobe type), it is more efficient to test each lobe (low and high-speed) separately and select the best of each test for the final camshaft specifications. While the *ProIterator* can run “combined” tests of both lobe profiles at once, this often results in a test series requiring a long time to complete.

Induction Tabbed Page

The third tabbed page sets up a standard, *Single- or Dual-Phase* test of the

Using The *ProLterator*™

The *Induction* tabbed page sets up a *Single-* or *Dual-Phase* test of the effects of various induction system components and dimensions. To perform an *Iterative* test of Induction components, select the *Single* or *Dual* radio button and select the manifolds/induction-systems that you would like to add to the test series. **Note:** Runner dimensions only apply to WA simulations.

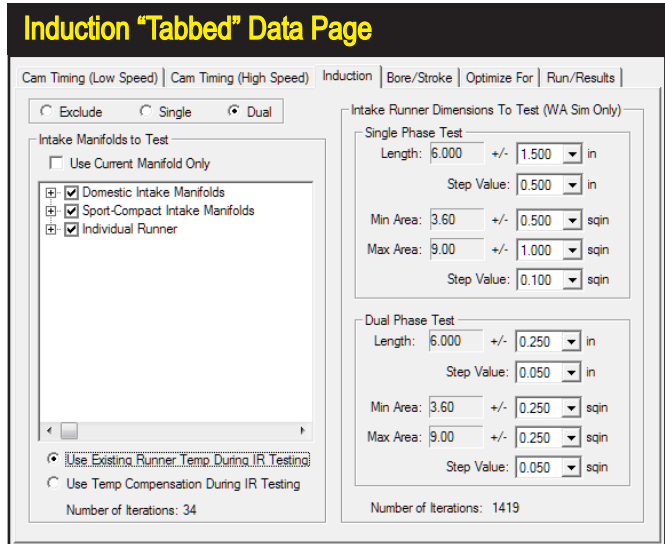

effects of various Induction Manifolds and (if the WA Simulation is selected) Runner Lengths and Dimensions on power or torque output. By default, the *Induction Tabbed Page* is set to **Exclude** (perform no induction tests) as shown in the radio buttons at the top-left of the page. To perform an iterative test of induction systems, select **Include** and check the manifolds/induction-systems that you would like to include in the test series.

You can also quickly setup an Induction system test of Intake Runner Lengths and Areas by clicking on the **Induction** button in the *QuickStart Preset* group (top of dialog box, described earlier).

Note: When selecting any of the *Individual Runner* induction systems, take note of the two additional radio-buttons: **Use Existing Runner Temp** and **Use Temp Compensation During IR Testing** that compensates for the lower temperatures of typical IR systems.

In most cases, you should enable *Use Temp Comp..* since this allow the simulation to alter runner temperatures, providing a more realistic environment when modeling a variety of manifolds that include both plenum and IR systems.

Bore/Stroke Tabbed Page

This tabbed page establishes a *Single-* or *Dual-Phase*™ test of bore-and-stroke dimensional changes on power or torque output. By default, the *Bore/Stroke Tabbed Page* is set to **Exclude** (perform no bore-and-stroke modifications) as shown in radio buttons at the top-left of the page. To include a Bore/Stroke Iteration, select either the **Single-** or **Dual-Phase** radio button and enter the testing criterion in the **Single- and/or Dual-Phase Test** boxes, located just below the radio buttons. You can quickly setup an comprehensive test by clicking the **Bore/Stroke** button in the *QuickStart*

Using The *ProLterator*TM

Bore/Stroke “Tabbed” Data Page

Cam Timing (Low Speed) | Cam Timing (High Speed) | Induction | **Bore/Stroke** | Optimize For | Run/Results

Exclude Single Dual Maintain Current Displacement

Single Phase Test

Bore: 81.00 +/- 10.00 mm
Stroke: 87.20 +/- 10.00 mm
Step Value: 1.0 mm
Number of Tests: 441

Dual Phase Test

Bore: 81.00 +/- 2.00 mm
Stroke: 87.20 +/- 2.00 mm
Step Value: 0.50 mm
Number of Tests: 81

Bore Limits
Minimum: 69.00 mm
Maximum: 93.00 mm

Stroke Limits
Minimum: 75.20 mm
Maximum: 99.20 mm

Displacement Limits
Minimum: 1124.77 cc
Maximum: 2695.41 cc

The *Bore/Stroke* tabbed page establishes an *Iterative* test of bore- and-stroke dimensional changes. Perform a *Bore/Stroke Iteration* by selecting either the *Single-* or *Dual-Phase* radio button and entering the testing criterion. You can chose to *Maintain Current Displacement* or let engine displacement vary throughout *Bore/Stroke* testing (see text for details).

Preset group (described earlier).

Note About Bore/Stroke Iteration: You can chose to *Maintain Current Displacement* or let engine displacement vary throughout *Bore/Stroke* Iterative testing. By checking the ***Maintain Current Displacement*** box, the ***Stroke*** within both ***Phase-Test*** boxes will switch to ***(Auto)***, indicating that *Stroke* will be allowed to vary as much as required to keep displacement constant while the ***Bore*** varies from its current value throughout the indicated (\pm) *Range*. Alternately, you can choose to allow *Bore* (rather than *Stroke*) to vary as much as required to keep displacement constant while *Stroke* changes from its current value throughout its (\pm) *Range*.

Follow these steps to change the ***(Auto)*** variable: 1) With *Maintain Current Displacement* checked, 2) set the *Bore* (\pm) *Range* value to zero, 3) then set the *Stroke* (\pm) *Range* to any desired value (except zero). The ***(Auto)*** function will switch to *Bore*.

Optimize For Tabbed Page

This tabbed page establishes the desired results from Iterative testing. By default, the *ProLterator*TM will search for the combination of components that produces *Peak Horsepower*. Alternately, you can select *Optimize For Peak Torque*. In addition to these two options, two additional ***Optimize*** choices are available: *Maximum Area Under The Horsepower Curve* or *Torque Curve*. While the peak torque and horsepower choices focus on absolute maximum values, the areas-under-the-curves selections will find parts combinations that produce the greatest “volume” of horsepower or torque within the selected rpm range.

In general, peak horsepower searches may find optimum components for narrow-rpm-band racing (like drag-racing), and maximum area under the curve

Using The *ProIterator*™

The *Optimize For* tabbed page establishes the goals for the *Iterator*. By default, the *ProIterator*™ will search for *Peak Horsepower*. While *Peak Torque* and *Peak Horsepower* choices focus on absolute maximum values, the *Areas Under The Curve* selections locate engine setups that produce the greatest “volume” of horsepower or torque. Think of this as the maximum horsepower or torque throughout the selected rpm range (over time).

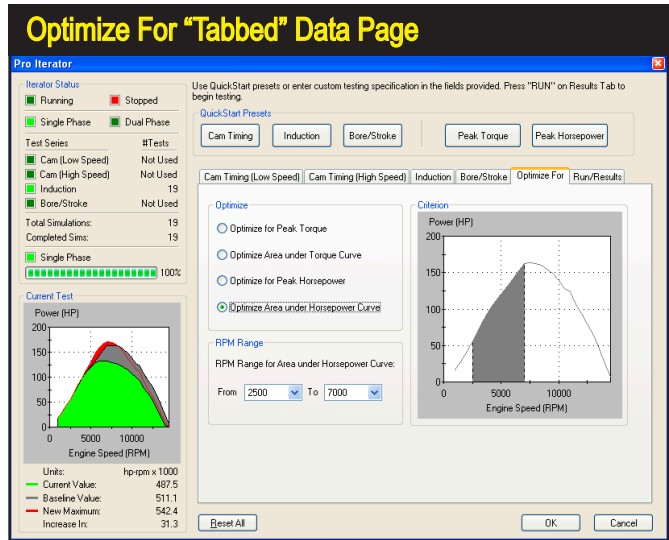

may find the best components for wide-rpm band racing (like road racing). Below the *Optimize* settings box, the *RPM Range* choices let you set the lower and upper limits through which the *Iterator* will search for optimum power or torque combinations. When the *Iterator* is searching for peak values, the *RPM Range* will be illustrated as dotted vertical lines on the *Criterion* graph. When either *Area Under The Curve* choice is selected, the *RPM Range* values will be displayed as a “bounded area” under the horsepower or torque curves.

Note: Optimizing engine components for maximum area under the curve is a unique way to look at engine power output. There is little published data on this method of evaluating engine power or torque, nor is there much research available on which racing applications may benefit from this analysis. Rumor has it, though, that racing teams have used this method to find a winning edge. Now you can use this powerful analysis method in the *ProIterator*™ to your advantage!

Run/Results Tabbed Page—Use this final tabbed page to begin an *Iterative* test series, to view testing progress, and to display the top ten results. Once you have selected testing parameters (on the *Cam Timing*, *Induction*, and *Bore/Stroke* tabbed pages) and set the optimization criterion, click the *Run* button to begin the *Iterative* test series. As the *ProIterator*™ locates promising results, they are displayed in the *Best Results* graph as vertical bars. A horizontal “baseline” within the graph indicates the power level of the current engine (established from components selected in the Component Categories on the Main Program Screen). As the *Iterator* finds better and better component combinations, the bars continue to increase in height (the graph axis will rescale as needed). If the *Iterator* finds combinations

Using The *ProIterator*TM

Run/Results "Tabbed" Data Page

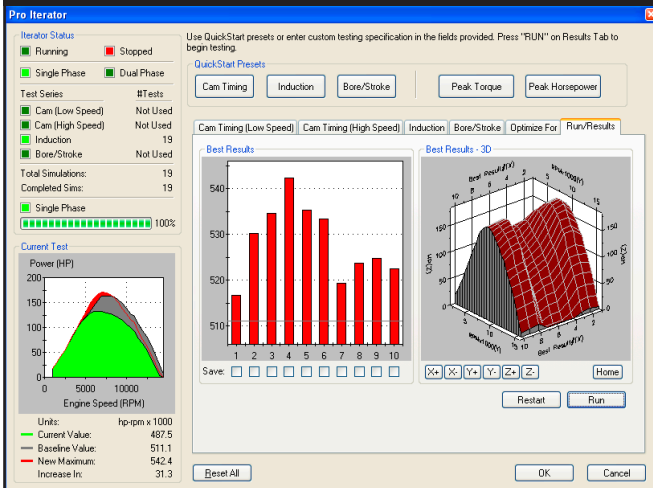

The *Run/Results* tabbed page will begin *Iterative* testing, display testing progress, and let you save any of the top ten results. When testing is complete, save any (or all) results by clicking specific *Save* boxes located below the vertical bars in the *Best Results* graph, then click *OK* to spawn (create) these engines within the simulation.

that produce more power or torque than the baseline engine, the vertical results bars will exceed the baseline and continue to grow taller. The top ten horsepower or torque curves that match the bar-chart results are displayed on the *Best Results—3D graph*. You can view these curves from any perspective using the *X+*, *X-*, *Y+*, *Y-*, *Z+*, and *Z-* buttons (*Home* returns the 3D graph to its original position).

During the calculation of an *Iterative* test series, you can view the number of completed and remaining simulations in the *Iterator Status* box (you can stop testing at any time by pressing the *Stop* button; press *Run* to continue testing or *Restart* to clear current results). Save any (or all) of the top ten results by clicking the individual *Save* boxes located below the vertical bars in the *Best Results* graph. After selecting which results to save, click the *OK* button at the bottom of the *ProIterator*TM dialog box. The *Iterator* will close and "spawn" (create) new engines based on the components that were used in the selected tests. You can switch to any of these new engines by clicking on the *Engine Selection Tabs* at the bottom of the *Main Component Screen* (continue modifying and testing as you would with any simulated engine).

The *ProIterator*TM will almost always find more power or torque. To pinpoint these improvements, you can quickly setup back-to-back comparisons with the original, baseline engine: Right-click on the power/torque graph of any *Iterator*-generated engine, select *Properties*, then include the baseline engine in one of the four *Data Sets* shown on the *Graph Data* page. The baseline engine curves will be included on the current graph, and the key-legend at the bottom of the graph will be updated.

Close/Save State (bottom)

Using The *ProIterator*™

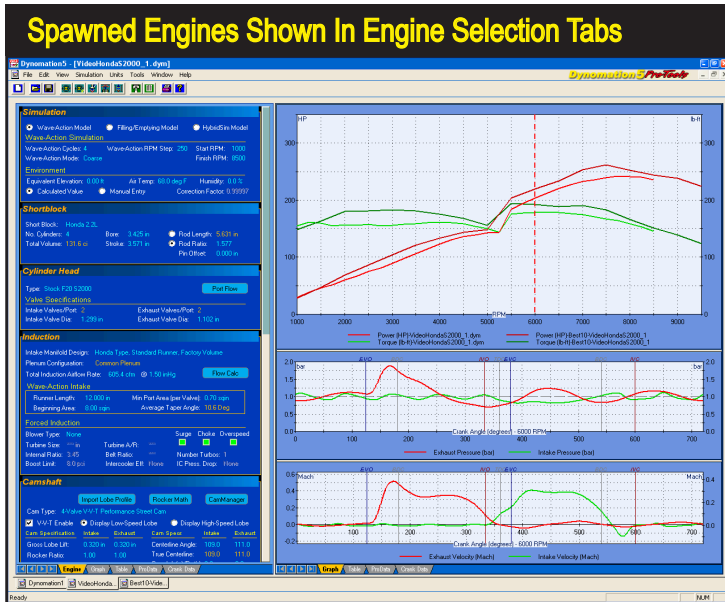

When you close the *Iterator* screen, new “spawned” engines will be created and displayed in the *Engine Selection Tabs* at the bottom of the Main Program Screen. Each new engine can be brought into the foreground by clicking on its *Selection Tab*. *Iterator*-spawned engines can be analyzed, tested, and modified in any way, just like any other engine in the simulation.

Closes the *Iterator* and saves the current testing setup (changing engine components of this saved engine may force the *Iterator* to reset to its default). Use the **Close/Save State** button when you wish to continue *Iterative* testing on the same engine using similar components and *Iterator* settings.

Close/Quit (bottom)

Closes the *Iterator* without saving the current state.

Reset All Button (bottom)

Resets the current setup to default within the *Iterator*, but leaves it open so you can begin to enter a new *Iteration* setup.

ProIterator™ Testing—A Quick Walkthrough

The first step in performing an *Iterative* test is to design the baseline engine. When the engine has been simulated, you may begin an *Iterative* test series. Open the *ProIterator*™ by choosing **ProIterator™ Testing...** from the **Tools** menu or by clicking the **ProIterator™ Icon** in the **Toolbar**. Use the tabbed data-entry-and-display pages to establish components and/or engine-systems for testing. Alternately, to quickly setup a test series you can use the *QuickStart* buttons at the top of the dialog box.

For this walkthrough, click on the **CamTiming QuickStart Preset** button. This establishes a *Dual-Phase* test based around current camshaft timing specifications. Notice that 2,401 tests will be performed during the first phase, and 6,561 tests will be run in *Phase-2* using the best result from the *Phase-1* as the starting point.

Using The *ProIerator*TM

During Phase-1 simulations, individual cam timing points (IVO, IVC, EVO, EVC) will be varied through a range of +/- 24 degrees in 8-degree steps. That's seven tests for each timing point, making the total number of tests performed during Phase-1 equal to 2,401 (7 x 7 x 7 x 7). When this first series is complete, the simulation will select the best result and begin *Phase-2* testing. This time, each valve event will be varied through a range of +/- 4 degrees in 1-degree steps. This means that nine tests will be needed for each timing point, resulting in 6,561 tests in this series (9 x 9 x 9 x 9). The total number of tests required to complete the entire Iterative test is the sum of each series, or 8,962. Any of the timing point values, their +/- ranges, or the step sizes can be altered to suit custom requirements.

Note: As you select *QuickStart Preset* buttons or enter data on individual tabbed pages, the *Iterator Status* box (upper-left of dialog) shows the component groups that have been included and the number of tests that must be performed to complete the current series. Since the program will typically perform 1 to 10 simulation tests per second (depending on the speed of your computer, the rpm range of the tests, etc.), keep in mind that it will take about an hour to execute 18,000 tests.

Keep the testing criterion limited and the range and step values large to minimize calculation times. Also, set the simulation rpm range as narrow as possible (set this in the *Simulation Category*).

Before Iterative test can begin, the results criterion you would like to optimize must be specified. For this walkthrough, press the **Peak Horsepower** button at the top of the Iterator dialog. When you click the button, the *Optimize For* tabbed page is selected and is setup with *Optimize For Peak Horsepower* within the RPM

Setting Up A Camshaft Iteration

Pro Iterator

Use QuickStart presets or enter custom testing specification in the fields provided. Press "RUN" on Results Tab to begin testing.

QuickStart Presets

Cam Timing Induction Bore/Stroke Peak Torque Peak Horsepower

Cam Timing (Low Speed) Cam Timing (High Speed) Induction Bore/Stroke Optimize For Run/Results

Exclude Single Dual

Single Phase Test

IVO: 34.0 +/- 24
IVC: 66.0 +/- 24
EVO: 77.0 +/- 24
EVC: 29.0 +/- 24
Step Value: 8
Number of Tests: 2401

Dual Phase Test

IVO: 34.0 +/- 4
IVC: 66.0 +/- 4
EVO: 77.0 +/- 4
EVC: 29.0 +/- 4
Step Value: 1
Number of Tests: 6551

Current Test

Power (HP) vs Engine Speed (RPM)

Unit: hp-rpm x 1000

Current Value: 2295.8

Baseline Value: 2295.8

New Maximum: 2295.8

Increase In: 0%

Reset All OK Cancel

For this walkthrough, click on the *CamTiming QuickStart Preset* button. This sets up a *Dual-Phase* test around current camshaft timing specifications. Notice that 2,401 tests will be performed on the first phase, and 6,561 tests will be run in *Phase-2* using the best result from the *Phase-1* as the starting point. See text for more information on how this Iterative test evaluates cam timing.

Using The *ProIerator*™

range of 2500- to 7500-rpm. Change the **Optimize** selection to *Optimize Area Under Horsepower Curve*. Notice that the graph display switches to show an area envelope under the curve that will be the focus of this *Ierator* test series.

Note: If you make any mistakes during setup selections on any of the tabbed pages, you can correct any error individually or click the **Reset All** button, located at the bottom of the screen, to clear all Presets and return the tabbed-pages to their default settings.

Now that all parameters have been entered, switch to the **Run/Results** tabbed page. Click the **Run** button to begin the test series. As the *ProIerator*™ finds promising results, they are displayed in the **Best Results** graph as vertical bars. A horizontal “baseline” on the graph indicates the power level of the initial engine (built from components on the Main Component Screen). As the *Ierator* finds better and better component combinations, the bars continue to increase in height (and the graph axis will rescale as needed). When the *Ierator* finds combinations that produce more power under the curve than the baseline engine, the results bars will cross over the baseline indicator. The top ten results are accumulated on the **Best Results—3D graph**. You can view these curves from any prospective using the **X+**, **X-**, **Y+**, **Y-**, **Z+**, and **Z-** buttons (**Home** returns the 3D graph to its original orientation).

Note: You can stop the testing process at any time by pressing the **Stop** button; press **Run** to continue testing or **Restart** to clear current test results.

When testing is complete, select the choices from the top ten results by clicking the individual **Save** boxes located below the vertical bars. Then click the **OK** button at the bottom of the *ProIerator*™ dialog box. When the *Ierator* closes, the simulation will add all the engines you’ve selected to the current display and place

Selecting Results Criterion

Pro Ierator

Iterator Status: Running Stopped

Use Quick-Start presets or enter custom testing specification in the fields provided. Press "RUN" on Results Tab to begin testing.

Quick-Start Presets:

Cam Timing (Low Speed) | Cam Timing (High Speed) | Induction | Bore/Stroke | **Optimize For** | Run/Results

Optimize:

- Optimize for Peak Torque
- Optimize Area under Torque Curve
- Optimize for Peak Horsepower
- Optimize Area under Horsepower Curve

RPM Range

RPM Range for Area under Horsepower Curve:

From: 2500 To: 7000

Current Test

Power (HP) vs Engine Speed (RPM)

Units: hp-rpm x 1000

Current Value: 2295.8

Baseline Value: 2295.8

New Maximum: 2295.8

Increase In: 0%

Buttons:

Before the Iterative test can begin, the desired results must be specified in the **Optimize For** tabbed page. To speed the process, you can click on either the **Peak Torque** or **Peak Horsepower** QuickStart Preset buttons. For this walkthrough, click on the **Peak Horsepower** button. Then change the Optimize selection to **Optimize Area Under Horsepower Curve**. That will display a shaded area under the power curve that is now the target for Iterative testing.

Using The *ProIerator*TM

Beginning The Test Series

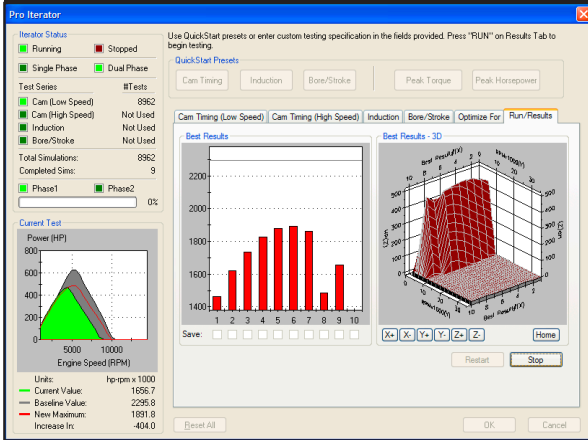

When all parameters have been entered, switch to the *Run/Results* tabbed page. Click the *Run* button to begin the test series. As the *ProIerator*TM finds promising results, they are displayed in the *Best Results* graph as vertical bars. A horizontal “baseline” on the graph (shown here near the top of the bar graph) indicates the power level of the baseline engine. As the *Iterator* finds better and better component combinations, the bars continue to increase in height.

them in the *Engine Selection Tabs* at the bottom of the *Main Program Screen* (see *Engine Selection Tabs* described earlier in this manual). Each test engine can be brought into the foreground by clicking on its Tab. *Iterator* “found” engines can be further analyzed, tested, and modified in any way, just like any other engine in loaded in the simulation. In fact, you can begin a *new Iterator* test using any of the spawned engines as a new baseline to further “home in” on desired results.

Tips For Running Efficient Iterative Tests

Setting up an *Iterative* series only takes a few seconds, however, if you include too many test parameters, ranges that are too wide, or step values that are too small, you will create an *Iterator* series that contains too many tests. If you create

Iterator Test Series Complete

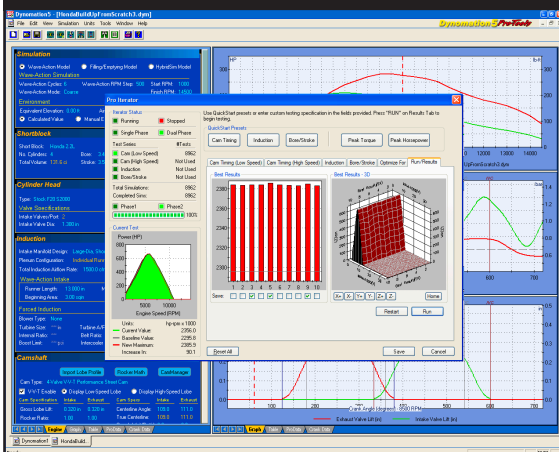

When testing is complete, pick your choices among the top ten results by clicking the Save boxes located below the vertical bars in the *Best Results* graph. Then click the OK button at the bottom of the *ProIerator*TM dialog box. When the *Iterator* closes, the simulation will spawn (create) all the engines you have selected and display them in the *Engine Selection Tabs* at the bottom of the *Main Program Screen*

Using The ProIerator™

Spawned Engines In Engine Selection Tabs

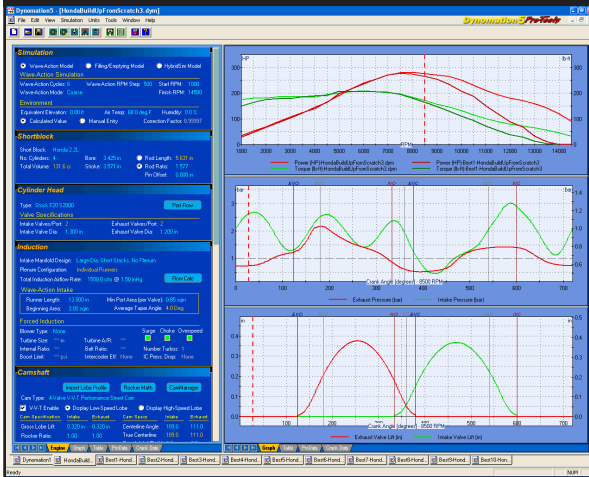

When the Iterator closes (after you have selected one or more engines from the Best Results list) the program will create the selected engines and display them in the *Engine Selection Tabs* at the bottom of the Main Program Screen. Each test engine can be brought into the foreground by clicking its Tab. Iterator-generated engines can be analyzed, tested, and modified in any way, just like any other engine in the simulation.

an excessively long test series even fast computer systems may require days or months to complete. In these cases, the simulation may request that you increase step values for selected parameters.

The best way to find optimum components, especially cam timing, is to setup a Dual-Phase™ test that uses large step values (20 degrees or more) to “get in the ballpark” on the first phase, then focus the second *Iteration* phase with a narrower range of values (perhaps just a 2 to 4 degrees) and a smaller step value (perhaps 1 degree) to precisely locate the best timing.

Narrowly-focused tests may still require many thousands of test cycles to complete. In these cases, it is possible to continue to use your computer while the

An Extremely Long Iterator Test Series

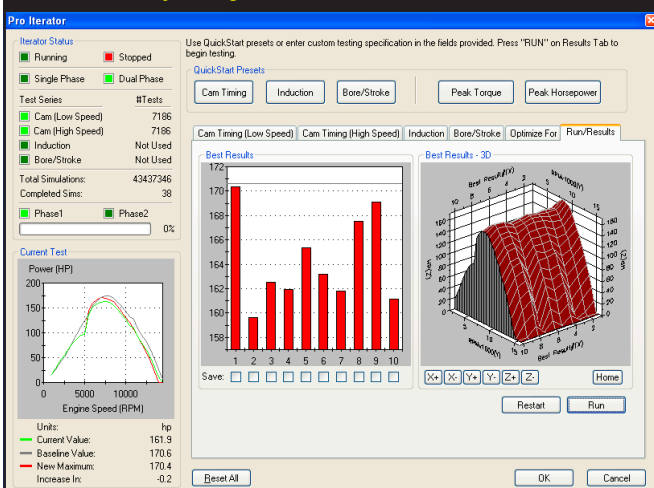

Narrowly-focused or multiple-component tests may require several thousand, or even millions of test cycles to complete. A test series as large as the one shown here, can require several days of calculation time depending on the speed of your computer. The same results can be obtained by a more carefully designed test that takes a fraction of the time to complete. Use wide first-phase ranges and steps to keep the number of iteration cycles to a minimum.

Using The *ProIterator*™

Iterator is still running. Simply use the **Start** menu to begin other applications or use **Alt-Tab** to switch between applications (see your Windows documentation for more information on program switching).

Note: You may also “minimize” the program and regain your desktop during an *Iterator* test.

Wave-Action Filling & Emptying Simulations Version 6

BUILT-IN CALCULATORS

The simulation incorporates several built-in calculators that will assist your data entry and analysis. Some are simple, one-step calculators, others are powerful, multi-step “math engines” that make short work of otherwise error-prone calculations. This chapter presents an overview of these calculators.

THE INDUCTION-FLOW CALCULATOR

The **Flow Rate** field in the **INDUCTION** category establishes the overall flow for the simulated induction system, typically limited by the throttle size and opening. Determining the flow rate for injectors or carburetors, especially if the flow rating is unknown, can be problematic. In these cases, the built-in *Flow Calculator* can help determine the appropriate total induction flow for the simulation. Open the *Flow Calculator* by clicking on the **Flow Calc** button in the **INDUCTION** category. The calculator presents two distinct calculation models: 1) the *Known Airflow Per Carb/Throttle*, and 2) *Known Throtte-Bore Diameter*.

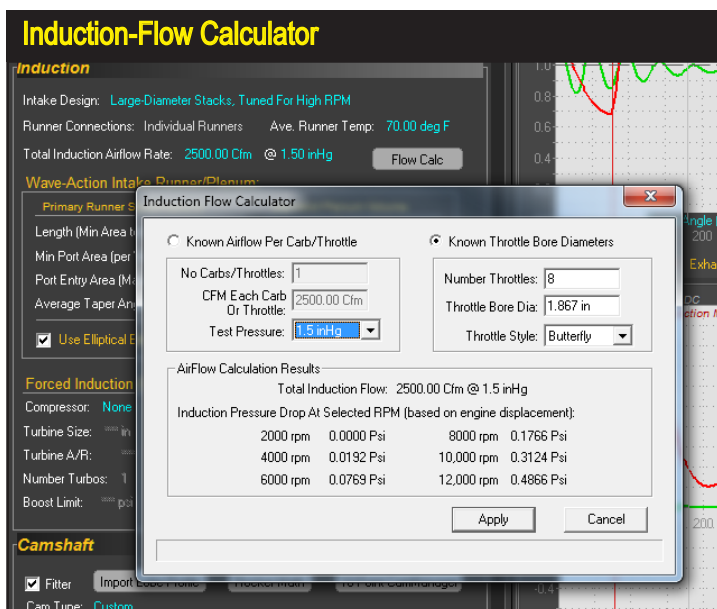

If you are modeling an induction system that uses multiple carburetors or injector “stacks,” you can use the built-in *Flow Calculator* to help determine total induction flow. Enter the number of throttles, the throttle bore diameter or the flow per throttle. The calculator will estimate the airflow for the entire system (flow for each throttle times the number of throttles).

Built-In Calculators & Tools

Flat-Side (Slide-Valve) Throttle



Carburetors and injector stacks use two common throttle mechanisms: 1) The “standard” throttle plate that pivots on a shaft through the middle of the throttle bore, and 2) A slide-valve that when in the wide-open throttle position, is retracted entirely from the throttle bore. These carburetors are commonly called “FlatSide” since the chamber to accommodate the slide valve gives the carburetors a “flat,” appearance on the sides.

To calculate the flow for an induction system when you only know the throttle-bore diameters (not the rated flow), select the right-hand radio button. Enter the number of “stacks” or “barrels,” the diameter of the throttle-bores, and select between *Butterfly* or *Flat-Side* throttle configurations (*a Flat-Side is a slide-valve throttle that, when opened fully, provides no restriction to flow*). The calculator will estimate the appropriate airflow for the entire system (flow for each throttle times the number of throttles). To apply the calculated airflow to the simulated engine, press the **Apply** button.

THE AIRFLOW PRESSURE-DROP CONVERTER

The simulation will accept induction airflow in CFM measured at a pressure drop of either 1.5- or 3.0-In/Hg (or in metric units). For those instances where an induction system, injector, or carburetor was flow tested at a different pressure drop, or whenever you would like to convert flow values from one pressure-drop rating to another, the **Airflow Pressure-Drop Converter** easily performs these conversion

The **Airflow Pressure-Drop Converter** is a general-purpose tool that will convert airflow to/from any pressure-drop standard. Activate the **Airflow Converter** by either selecting **Airflow Pressure-Drop Converter...** from the **Tools** menu or by clicking on the **Airflow Converter** icon in the **Toolbar**.

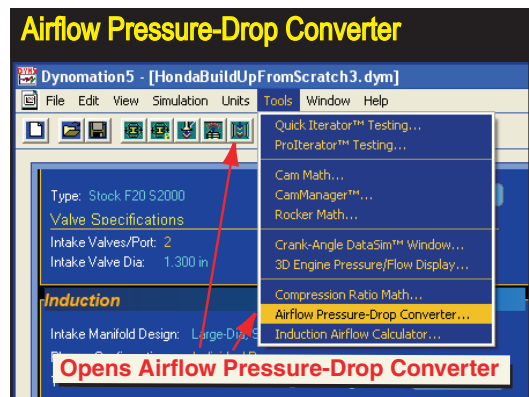

Built-In Calculators & Tools

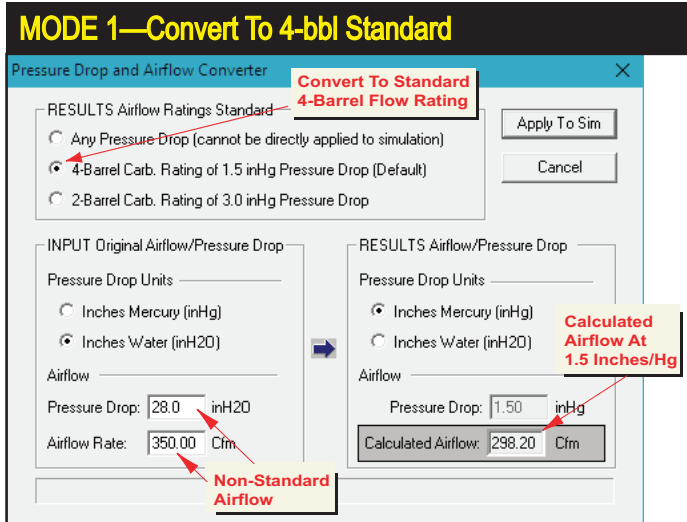

MODE 1: When the calculator is first activated, the *Airflow Ratings Standard* is set to **4-Barrel Rating at 1.5-in/Hg Pressure Drop**. To convert from any known airflow to this flow standard, enter the known airflow and pressure drop in the *Known Airflow* category. The airflow at the 4-barrel rating standard will be displayed in the *Calculated Airflow* category.

functions. This tool can also convert flow ratings measured in inches-of-mercury (in/Hg) of depression to and from airflow values rated in inches-of-water (in/H₂O).

Note: A pressure drop of 1.5-in/Hg is equivalent to 20.3-in/H₂O.

The **Airflow Pressure-Drop Converter** has three basic modes of operation: 1) Convert flow to the 4-Barrel Standard pressure-drop rating, 2) convert to the 2-Barrel Standard pressure-drop rating, and 3) calculate airflow between any two pressure-drop rating levels. Each of these methods are described below. Activate the **Airflow Pressure-Drop Converter** by either selecting *Airflow Pressure-Drop Converter...* from the **Tools** drop-down menu or click on the **Airflow Icon** located in the **Toolbar**.

Using The Airflow Pressure-Drop Converter

Mode 1:

Convert Any Flow To 1.5-in/Hg—The 4-Barrel Standard.

When the calculator is first activated, the **1.5-in/Hg Airflow Ratings Standard** “radio button” is selected. The **RESULTS** category also defaults to a fixed pressure drop of **1.5-in/Hg** or **20.3-in/H₂O** (these pressure drops are identical). To convert any known airflow measured at any pressure drop to the **1.5-in/Hg**, 4-barrel standard, enter the measured airflow and pressure drop in the **INPUT** category (if needed, you can switch between Inches-of-Mercury[Hg] and Inches-of-Water[H₂O] by clicking on the appropriate radio buttons in the **INPUT** and **RESULTS** categories). The converted airflow will be displayed in the **Calculated Airflow** field. You can change to any of the previous fields (by clicking on them or using the Tab or SHIFT-Tab keys) to explore their effects on calculated airflow. At any time, you can click **Apply To Sim** to load the new calculated airflow into the **Total Induction Airflow**

Built-In Calculators & Tools

MODE 2—Convert To 2-Bbl Standard

MODE 2: Switch the Airflow Ratings Standard to 2-Barrel Rating at 3.0-in/Hg Pressure Drop.

Enter the known airflow and pressure drop in the **Known Airflow** category. The airflow at the 2-barrel rating standard will be displayed in the **Calculated Airflow** category.

Rate field in the *Induction* category. Alternately, you can press **Cancel** to discard all entries and close the *Airflow Pressure-Drop Converter*.

Mode 2:

Convert Any Flow To 3.0-in/Hg, The 2-Barrel Standard.

Switch the **RESULTS—Airflow Ratings Standard** category selection to the radio button marked **2-Barrel Carb of 3.0-in/Hg Pressure Drop**. This changes the **RESULTS Airflow/Pressure Drop** category to a fixed 3.0-in/Hg (40.7-in/H₂O) pressure drop. To convert any airflow measured at any pressure drop to the 3.0-in/Hg, 2-barrel standard, enter the known airflow and pressure drop in the **INPUT** category (you can switch between *Inches-of-Hg* and *Inches-of-H₂O* by clicking on the appropriate radio buttons in the **INPUT** and **RESULTS** categories). The converted airflow will be displayed in the **Calculated Airflow** field. You can change any of the previous fields (by clicking on them or using the Tab or SHIFT-Tab keys) to explore their effects on calculated airflow. At any time, you can click **Apply To Sim** to load the new, converted airflow into the **Total Induction Airflow Rate** field in the *Induction* category. Alternately, you can press **Cancel** to discard all entries and close the *Airflow Pressure-Drop Converter*.

Mode 3:

Convert Any Airflow To Equivalent Flow At Any Pressure-Drop.

Switch the **RESULTS—Airflow Ratings Standard** category to the radio button marked **Any Pressure Drop**. This allows the **INPUT** and **RESULTS** to be set to any pressure drop measured in *Inches of Hg* or *Inches of H₂O*. Enter the known airflow and pressure drop in the **INPUT** category. Then enter the desired pressure

Built-In Calculators & Tools

MODE 3: Switch the **Airflow Ratings Standard** to **No Ratings Standard**. Enter the **Known Airflow** at any pressure drop measured in Inches of Hg or H₂O. Then enter the desired pressure drop in the **Calculated Airflow** category. The equivalent airflow will be displayed in the **Airflow Rate** field.

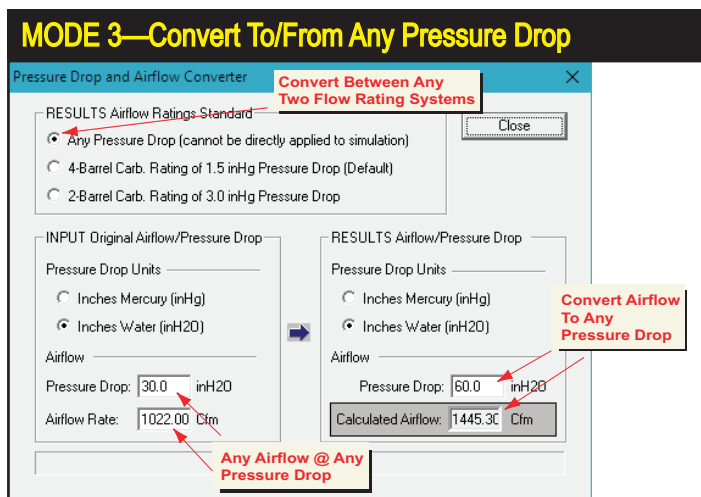

drop in the **RESULTS** category. The calculated equivalent airflow will be displayed in the **Calculated Airflow** field. You can modify any of the fields (by clicking on them or using the Tab or SHIFT-Tab keys) to explore their effects on calculated airflow.

Note: Since the **Total Induction Airflow Rate** field in the **Induction** category accepts only airflow values rated at either 1.5- or 3.0-in/Hg (20.3- or 40.7-in/H₂O), the **Apply To Sim** button is not available when **No Ratings Standard** is selected. If you wish to use the new calculated values in a dyno test, select either the **1.5-in/Hg** or **3.0-in/Hg Pressure Drop** in the **RESULTS—Airflow Ratings Standard** group at the top of the calculator dialog.

Rocker-Math Calculator

The Camshaft Category includes an in-depth **Rocker-Math Calculator** tool that will help you determine how and why changes in **Rocker Ratio** can have subtle effects on valve timing.

IMPORTANT: Follow this simple rule when using Rocker Math: Enter the baseline **Rocker-Ratio** specifications (used by the cam manufacturer to determine their published valve-event timing, duration, etc.) in the Camshaft Category **FIRST!** Then use the **Rocker Math Calculator** to determine how changes to the initial values affect cam timing, valve lift, and engine power.

The **Rocker-Math Calculator** analyzes the subtle changes to valve-event timing that can occur when rocker-arm ratios are modified. When the intake or exhaust rocker-arm ratio is changed, overall valve lift is altered directly by the increase or decrease in ratio. It is clear that an increase in rocker ratio will open the valve further and increase valve acceleration. But what is less obvious is that rocker-ratio changes can also affect valve-open duration. When you click the **Apply** button af-

Built-In Calculators & Tools

Rocker Math Calculator Overview

Rocker Math Calculator

IMPORTANT: First enter recommended Rocker Ratios in the Camshaft Category, then this use this calculator to modify Rocker Ratios and determine the effects on valve lift and duration.

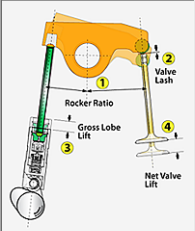

	Intake	Exhaust
Original Rocker Ratio:	1.50	1.50
New Rocker Ratio:	1.75	1.60
Valve Lash (in)*:	0.015	0.020
Gross Lobe Lift:	0.582 in	0.566 in
Valve Lift W/Org Ratio:	0.858 in	0.828 in
New Net Valve Lift:	1.003 in	0.885 in

* NOTE: Apply lash changes in the CamShaft Category. Lash timing changes are incorporated in True Timing.

Effects On Valve Timing (Seat-To-Seat)

Original Rocker-Ratio and Valve-Lash						
54.0	84.0	305.0	102.0	52.0	315.0	5.24
IVO	IVC	Original Duration	EVO	EVC	Original Duration	Acceleration Rate

Estimated Timing Changes With New Rocker Ratio and

Timing Changes:	0.6	0.7	1.3	0.3	0.3	0.6
	IVO	IVC	New Duration	EVO	EVC	New Duration
Estimated TRUE Timing:	48.6	77.7	306.3	93.3	42.3	315.6

APPLY Timing Changes / Close DISCARD All Changes / Close

To properly use the Rocker Math Calculator: *Enter the original manufacturer's cam specification for Rocker Ratio in the Camshaft Category FIRST!* Then use the *Rocker Math Calculator* to determine how **CHANGES** to the baseline ratios will affect valve timing, valve lift, and engine power. In this photo, the cam manufacturer's specified rocker ratio of 1.5 was increased to 1.75 for the intake and 1.6 for the exhaust. The intake timing changed more than one degree and the exhaust duration has increased about 0.6 degrees.

Enter new rocker ratios in the boxes (1). Changes in valve lift are displayed in (4). Changes in seat-to-seat valve timing and duration are shown in the *Effects On Valve Timing* area. If you click *Apply*, the new rocker ratios, and changes in timing and valve lift will be transferred to the *Camshaft Component* category and used in the simulation.

Rocker-Math Calculator Data Entry

Rocker Math Calculator

IMPORTANT: First enter recommended Rocker Ratios in the Camshaft Category, then this use this calculator to modify Rocker Ratios and determine the effects on valve lift and duration.

Enter CHANGES in Rocker Ratio and Lash here

	Intake	Exhaust
Original Rocker Ratio:	1.50	1.50
New Rocker Ratio:	1.75	1.60
Valve Lash (in)*:	0.015	0.020
Gross Lobe Lift:	0.582 in	0.566 in
Valve Lift W/Org Ratio:	0.858 in	0.828 in
New Net Valve Lift:	1.003 in	0.885 in

* NOTE: Apply lash changes in the CamShaft Category. Lash timing changes are incorporated in True Timing.

View CHANGES in Valve Lift here

Effects On Valve Timing (Seat-To-Seat)

Original Rocker-Ratio and Valve-Lash						
54.0	84.0	305.0	102.0	52.0	315.0	5.24
IVO	IVC	Original Duration	EVO	EVC	Original Duration	Acceleration Rate

Estimated Timing Changes With New Rocker Ratio and

Timing Changes:	0.6	0.7	1.3	0.3	0.3	0.6
	IVO	IVC	New Duration	EVO	EVC	New Duration
Estimated TRUE Timing:	48.6	77.7	306.3	93.3	42.3	315.6

View CHANGES in Duration here

APPLY Timing Changes / Close DISCARD All Changes / Close

Built-In Calculators & Tools

When you click the *Apply* in the *Rocker-Math Calculator*, valve event timing changes are transferred to the *Camshaft Component* category and placed in specific *Cam Modeling Input* fields dedicated to rocker-math changes. To *Reset* or *Undo* these changes, re-enter the original rocker ratios in the *Rocker-Math Calculator*. You can also click *Reset* in the *Camshaft Component* category, however, this only resets the timing changes to zero; the rocker ratios must be manually returned to their original values.

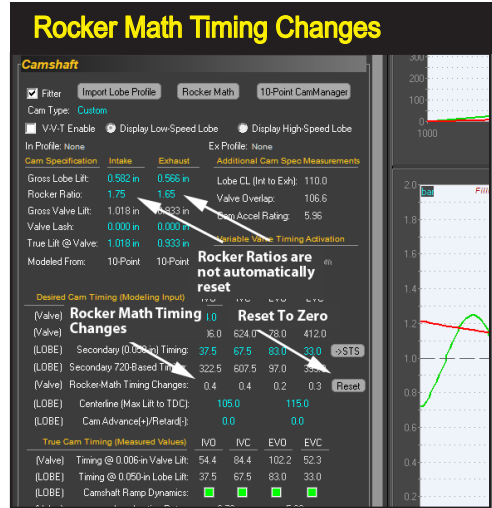

After entering rocker-ratio changes in the Calculator, valve event timing changes are transferred to the *Camshaft Component* category and placed in specific fields only used for rocker-math changes.

Note-1: If you wish to “undo” Rocker-Math Calculator changes (after they have been applied to the simulation), either reopen the calculator and reenter the original rocker ratios, or use the **Reset** button next to the *Rocker Math Timing Changes* fields in the *Camshaft Component*, then manually reset the rocker ratios to their original values.

Note-2: Changes in valve lash (independent of rocker-ratio) can have a significant effect on valve timing, duration, and engine output. You can model these changes directly in the *Camshaft Category* by simply changing the intake and/or exhaust lash values and reviewing the timing and lift changes in the *True Cam Timing* fields. In some cases, reducing lash by 0.005-inch to 0.010-inch can (depending on cam design) add 10 degrees or more to seat-to-seat valve duration!

THE CAM-MATH QuickCalculator™

The basic eight valve events (IVO, IVC, EVO, & EVC in both Seat-to-Seat and 0.050-inch timing) are required for the simulation to pinpoint opening and closing points of the intake and exhaust valves. IVO and EVO signal the beginning of mass flow in the intake and exhaust ports. The closing points, IVC and EVC, mark the end of mass flow. Unfortunately, some cam catalogs and other information sources only offer the lobe-center angles and duration values, leaving the conversion to IVO, IVC, EVO, and EVC up to you.

While these conversions can be accomplished in the *CamManager*, we also include a simple **Cam-Math QuickCalculator™** that easily converts the lobe-

Built-In Calculators & Tools

The **Cam-Math QuickCalculator** is available from the Tools menu. If a V-V-T cam is currently simulated, you can select between two versions of the QuickCalculator: low-speed and high-speed versions. Use **Cam-Math QuickCalculator** to easily modify Lobe Center Angles or Duration values.

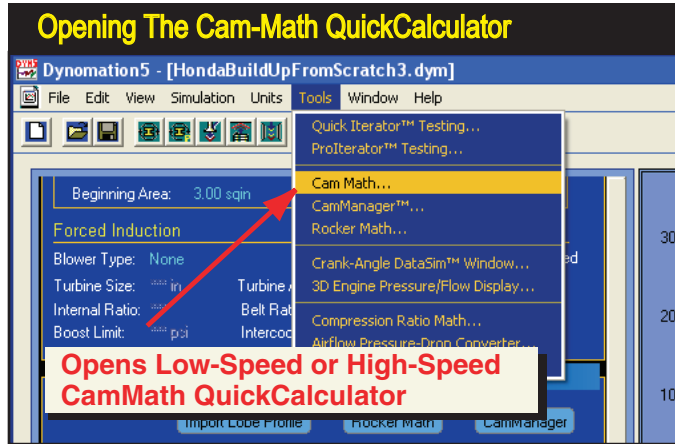

center angle, intake centerline, and the duration values into IVO, IVC, EVO, and EVC valve events ready for use in the simulation. One click of the **Apply** button transfers event-timing values into the **CAMSHAFT** category for use as **Primary** (Seat-To-Seat) or **Secondary** (0.050-inch) timing events. Furthermore, if you are using a VVT cam, you can specify if you would like to transfer the event timing to the low- or high-speed cam.

Note: In order for the **Cam-Math QuickCalculator** to determine valve opening and closing events, **BOTH** the **Lobe-Center Angle** **AND** the **Intake Centerline** must be entered. Without the **Intake Centerline**, there is no way to determine

Cam-Math QuickCalculator™

Cam Math Calculator (Low Speed Lobe)

Low Speed Lobe High Speed Lobe

Enter Cam Timing Specs

Lobe Center Angle: 112.0 Intake Centerline: 106.0
(cam degrees) (crank degrees)

Intake Duration: 294.0 Exhaust Duration: 294.0
(crank degrees) (crank degrees)

Intake Lift @ Valve: 0.595 in Exhaust Lift @ Valve: 0.595 in

Calculated Valve Timing Points

IVO (degrees BTDC): 41.0 IVC (degrees ABDC): 73.0

EVO (degrees BBDC): 85.0 EVC (degrees ATDC): 29.0

Apply To PRIMARY Cam Timing (Seat-To-Seat)

Apply To SECONDARY Cam Timing (0.050 Points) Cancel

The **Cam-Math QuickCalculator** allows direct entry and conversion of cam-manufacturer published data. Since this **Cam-Math Calculator** opens with the timing events currently used in the simulation, it also simplifies changing the lobe centerline angle and duration values.

Built-In Calculators & Tools

how the cam is “timed” or “indexed” to the crankshaft. Many (unfortunately not all) cam manufacturer catalogs provide sufficient information to determine valve-event timing. If you have a catalog or have visited a website that does not provide this information, try another cam manufacturer.

If IVO, IVC, EVO and EVC cam-timing values were already entered in the **CAMSHAFT** Category, the **Cam-Math QuickCalculator** will display the lobe-center angle, intake centerline, and duration values for the current cam and accept any changes you would like to make. As you modify the data fields, the corresponding IVO, IVC, EVO and EVC points will be calculated and displayed. You may then either accept the calculated values and transfer them to the **CAMSHAFT** category by clicking one of the **Apply** buttons or discard the new values and close the **Cam-Math QuickCalculator** by clicking **Cancel**.

THE COMPRESSION-RATIO CALCULATOR

You can select and test a wide range of compression directly in the **Combustion Component** category. However, many engine builders need to directly enter combustion-chamber volumes, head-gasket thickness, etc., to calculate or modify the compression ratio. The **Compression-Ratio Calculator** quickly performs these functions. In addition, this tool is more than a simple calculator, it adjusts itself to the needs of the engine builder; changing the way it functions depending on whether combustion volumes are known values or need to be measured directly from engine components.

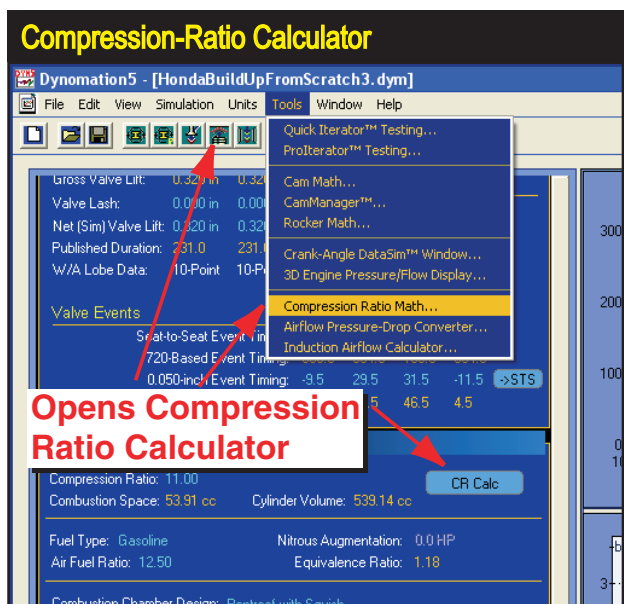

Activate the **Compression-Ratio Calculator** by clicking on the **CR Calc** button in the **Combustion Component** category, by selecting **Compression Ratio Math** from the **Tools** menu, or by clicking on the **Compression Ratio Icon** in the **Toolbar**.

Built-In Calculators & Tools

After you have specified the bore, stroke, and number of cylinders for the engine under test, activate the **Compression-Ratio Calculator** by clicking the **CR Calc** button in the **COMPRESSION** component category (see photo, below). When the calculator is first activated, it defaults to the *Known Volumes* mode. This is the most straightforward model for calculating compression ratio. Simply enter the required values in the **Compression-Ratio Calculator** and the compression-ratio will be calculated and displayed.

Using Known Dome/Dish/Deck/Chamber Volumes

If an engine builder is provided with the exact volumes displaced in the dome and valve pockets by the piston manufacturer, and the volumes of the combustion chamber, the deck height, and the specifications for the head gaskets are also known, a simple, numeric-only method can be used to calculate compression ratio. This procedure is explained in this section. However, in those cases where piston specifications are unknown (not provided by the manufacturer or machine work has been performed on the dome/pockets), the engine builder must directly measure dome/pocket volumes. In these situations, refer to the next section **Burette-Measured Volumes**.

Known-Volumes Mode

Here are the steps for using the compression-ratio calculator in the *Known-Volumes*

CR Math Calculator—Known Volumes Mode

Compression Ratio Calculator

Current Engine Specs

Bore: 4.155 in Cylinder Vol: 861.00 cc Total Vol: 420.3 ci
Stroke: 3.875 in Combustion Vol: 85.25 cc Compression Ratio: 11.10

Compression Ratio Volumes

Select Method of Compression Ratio Calculation:

Piston Dome/Deck/Relief Specs Known
 Measure Piston Dome/Reliefs With Burette

1 Head Chamber Volume: 75.00 cc
2 Dome Volume: 32.00 cc
3 Valve Reliefs Volume: 5.00 cc
4 Deck Clearance @ TDC: 0.075 in
Calculated Deck Volume @ TDC: -10.34 cc
5 Head Gasket Bore: 4.50 in
6 Head Gasket Thickness: 0.040 in
Head Gasket Volume: 10.42 cc

Calculated New Compression Ratio

Swept Cylinder Vol: 861.00 cc Total Combustion Vol: 75.08 cc Compression Ratio: 12.47

When the **Compression-Ratio Calculator** is first activated, it defaults to the *Known Volumes* mode. Simply enter the needed values in fields 1 through 6, and the **Compression-Ratio** will be displayed.

Built-In Calculators & Tools

To measure how far down the bore the piston is positioned at TDC, use a dial indicator and stand. Enter a positive number for “down-the-bore” distances and a negative number if the piston protrudes above the deck surface. A typical value might be +0.040, indicating that the piston comes to a rest at TDC 0.040-inch below the deck surface.

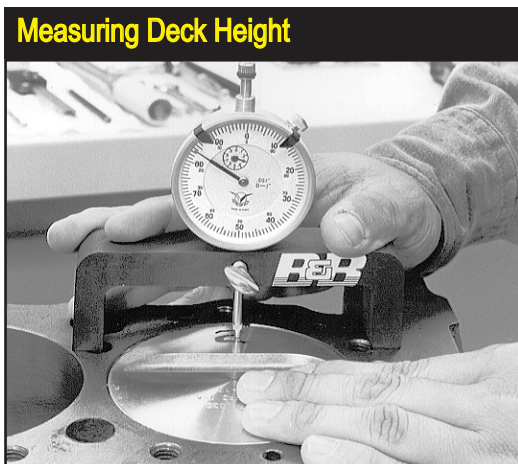

Mode. Start off by verifying that the upper radio button **Piston Dome/Deck/Relief Specs Known** has been selected. Next, enter the combustion-chamber volume (in cubic centimeters—cc’s) in the (1) **Head Chamber Volume** data box. Next, enter the volume displaced by the piston dome in (2) **Dome Volume** and the volume of the valve reliefs in one piston into (3) **Valve Reliefs Volume**. If your piston manufacturer provided one value for both of these volumes, enter this combined volume in the (2) **Dome Volume** field and enter zero in field (3).

Note: If any of these values are unknown, they must be manually measured (with a burette; see the next section for *Burette-Measured Volumes*).

The next data entry field is (4) **Deck Clearance @ TDC**. This dimension indicates how far down the bore the piston is located when positioned at TDC. Enter a positive number for “down-the-bore” distances and a negative number if the piston protrudes above the deck surface. A typical value might be +0.040-inch, indicating that the piston comes to a rest at TDC positioned 0.040-inch below the deck surface.

Important Note: A *positive Deck Clearance @ TDC* indicates the piston is positioned below the deck surface and this volume adds to the combustion space at TDC; a negative number indicates the piston protrudes above the deck surface at TDC and reduces the combustion space.

The next two data-entry boxes are used to calculate the volume added to the combustion space by the head gasket that is compressed between the cylinder head and the block-deck surface. The data box marked (5) accepts the **Head Gasket Bore** diameter (in the appropriate Metric or U.S. units). Most head gaskets have a “bore-circle” or “bore diameter” larger than the cylinder-bore diameter. For gaskets with bore-circles of odd shapes, simply estimate the bore circle by averaging the larger and smaller dimensions. Finally, enter the compressed (6) **Head Gasket Thickness**. This dimension is often available from the head-gasket manufacturer.

Built-In Calculators & Tools

When the compressed thickness is entered, the **Head Gasket Volume** and the **Compression Ratio** are calculated.

At this point, you can change any data-input values and determine their effects on compression ratio. At any time, you can click **Apply** to load the calculated compression ratio into the **COMPRESSION** category and save all entered values for the simulated engine. Alternately, you can press the **Cancel** button to discard all entries and leave any previously entered compression ratio-value unchanged.

Using Burette-Measured Volumes

If you are using pistons with domes, dishes, or valve-pockets/reliefs of unknown volumes, determining the compression ratio requires a bit more work. Each of these volumes must be accurately measured so that the net effect of all “positive” (domes) and “negative” (pockets, reliefs) can be included in the calculations.

Burette-Measured Mode

Start off by verifying that the lower radio button **Measured Piston Dome/Reliefs With Burette** is selected. Enter the combustion chamber volume (in cubic centimeters—cc’s) in the first **(1) Head Chamber Volume** data field. The next entry, **(2) Piston Down From TDC For Burette Measurement**, is a more-or-less arbitrary distance down the bore (measured from the deck surface) of sufficient depth so that the entire piston dome is located below the deck surface. Typical values may be 0.100-inches or 0.250-inches depending on the height of the piston dome (any distance is acceptable as long as the entire dome is positioned below the deck

When the **Compression-Ratio Calculator** is switched to the **Burette Measured Mode**, the data fields are redefined to allow the engine builder to input individual volumes that sum to determine the **Calculated Deck Volume @ TDC**. To measure this volume, the piston is lowered down the bore until the dome is entirely below the deck surface **(2)**, and a direct measurement is taken of the cylinder volume using a burette. After entering this volume and the head gasket specs, the compression-ratio is displayed.

CR Math Calculator—Burette Measured Mode

Compression Ratio Calculator

Current Engine Specs
Bore: 4.155 in Cylinder Vol: 861.00 cc Total Vol: 420.3 ci
Stroke: 3.875 in Combustion Vol: 85.25 cc Compression Ratio: 11.10

Compression Ratio Volumes

Select Method of Compression Ratio Calculation:
 Piston Dome/Deck/Relief Specs Known
 Measure Piston Dome/Reliefs With Burette

① Head Chamber Volume: 75.00 cc
② Piston Down Bore From TDC For Burette Measurement: 0.350 in
Measured Liquid Volume Above Piston: 67.50 cc
Calculated Deck Volume @ TDC: -10.27 cc
③ Head Gasket Bore: 4.500 in
④ Head Gasket Thickness: 0.040 in
Head Gasket Volume: 10.42 cc

Calculated New Compression Ratio
Swept Cylinder Vol: 861.00 cc Total Combustion Vol: 75.15 cc **Compression Ratio: 12.46**

Enter Head Gasket Bore Diameter Value Within Range: 1.000 to 9.000 in

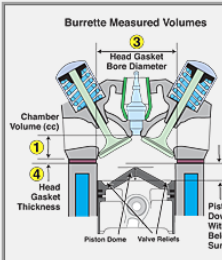

Built-In Calculators & Tools

Measuring Dome/Deck Volume

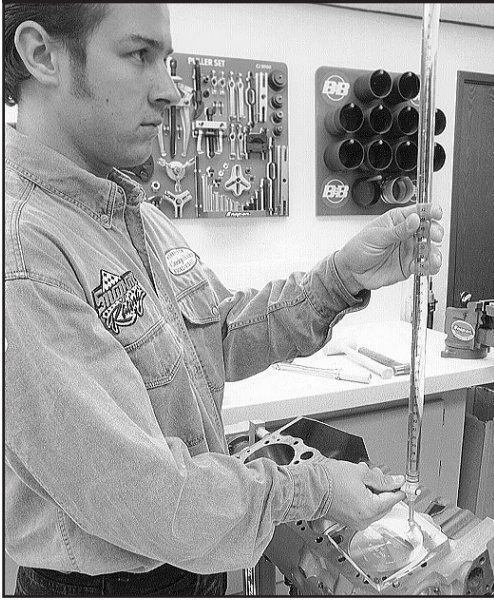

Measure the volume above the piston while the highest portion of the piston dome is positioned below the deck surface. Enter this value in field (5) **Volume Above Piston**. The difference between this volume and the volume of a simple cylinder [of a height equal to the value entered in field (4)] is the **Deck Volume At TDC**. This volume is equivalent to the combined volumes in the dome, dish, and valve reliefs in the piston. A negative **Deck Volume At TDC** indicates that the dome reduces the combustion space and will increase the compression ratio over a flattop piston. A positive value indicates that the sum of all dome/deck/dish/relief volumes will increase the combustion volume and decrease the compression ratio over a flattop piston.

surface). At this depth, a direct measurement is made of the **Volume Above The Piston** in the cylinder (sometimes called *Dome/Deck Volume*). This measurement is taken by the engine builder using a liquid-filled burette to fill the space above the piston (a flat Plexiglas plate is often used to seal the top of the bore; grease is typically used to seal the piston to the bore). For pistons with positive dome volumes, the volume of liquid dispensed will be less than the volume for a simple cylinder of the same height. The liquid volume dispensed from the burette is entered in the **Measured Liquid Volume Above Piston** field. The difference between this volume and the volume of a simple cylinder (of a height equal to the value entered in field (2)) is the **Calculated Deck Volume At TDC**, a volume equivalent to the sum of the dome, dish, relief, and deck volumes of the piston.

Important Note: A negative **Calculated Deck Volume At TDC** indicates that the total dome/deck/relief volumes reduce the combustion space and will, therefore, increase the compression ratio over a flattop piston. A positive value indicates that the sum of all dome/dish/relief volumes will increase the combustion space volume and decrease the compression ratio over a similar flattop piston (with the same deck height at TDC).

The next two data-entry fields are used to calculate the volume added to the combustion space by the head gasket compressed between the cylinder head and the block deck surface. The data box marked (3) accepts the **Head Gasket Bore** diameter (in the appropriate Metric or US units). Most head gaskets have a “bore-circle” or “bore diameter” larger than the cylinder-bore diameter. For gaskets with bore-circles of odd shapes, simply estimate the bore circle by averaging the larger

Built-In Calculators & Tools

and smaller dimensions. Next, enter the compressed **(4) Head Gasket Thickness**. This dimension is often available from the head gasket manufacturer. When the compressed thickness is entered, the **Head Gasket Volume** and **Compression Ratio** are calculated and displayed.

At this point, you can change any data-input values and determine their effects on compression ratio. At any time, you can click **Apply** to load the new calculated compression ratio into the **COMPRESSION** component category and save all entered values with the simulated engine. Alternately, you can press the **Cancel** button to discard all entries and leave any previously entered compression ratio value intact.



PRINTING

PRO-PRINTING™ ENGINE DATA AND RESULTS CURVES

The simulation can print a complete report of dyno-test results, including engine components, cylinder head airflow data, exact engine-test result values, 2D graphic displays of several engine-test variables and much more. Called **ProPrinting™**, this professional printout comprises a multi-page, dyno-test document of the currently-selected engine

ProPrinting™ features include custom page graphics, a cover page with the name and address of your business (or your personal name and address) and logo, a table of contents, optional text printed at the bottom of each page (can be a disclaimer, copyright notice or any other text you wish), even an optional glossary of common terms can be printed with your engine simulation report.

The full-color **ProPrinting™** report is “assembled” within the simulation and delivered to your default Internet browser (e.g., *Internet Explorer™*, *Chrome*, *FireFox*, *Opera*, etc.). Printing is performed within your Browser either in the foreground (for *Print-Preview*) or in the background (for non-preview, direct printing; only available with *Internet Explorer*). You can direct the output to any installed Windows printer.

Note: Some browsers, like the deprecated *Internet Explorer*, do not print “background graphics” by default. This can prevent the printing of background colors in many of the data tables and other graphics in **ProPrinting™** reports. To enable full-function printing, open the *Options* choices (typically located in the *Tools* or *Setup* menus—you may have to choose the *Advanced* options—and enable *Print Background Colors and Images*).

ProPrinting™ Functions And Setup

The **ProPrinting™** capabilities are another exclusive feature of this simulation. The ProPrint™ dyno-test report consists of fully-formatted data pages built from an HTML template. This template is “filled” with data from your current simulation which is sent to your default Internet browser for viewing and subsequent printing. Your Internet Browser is used for print-preview and to perform the complex process of converting the HTML into specific instructions that your printer can understand. By using the graphic capabilities of HTML, the simulation is able to produce a fully-formatted, professional test report.

ProPrinting™ Features

There are three *ProPrint*™ choices in the File menu that will help you setup report formats and initiate report printing.

ProPrint—Opens a dialog box that allows the selection of a printer; clicking OK from this dialog starts printing (only available in *Internet Explorer*). **ProPrint Preview**—Opens the ProPrint report within your Internet Browser so you can review each page. **ProPrint Setup**—Opens a dialog box that allows you to select the information that is included on the pages of the ProPrint report.

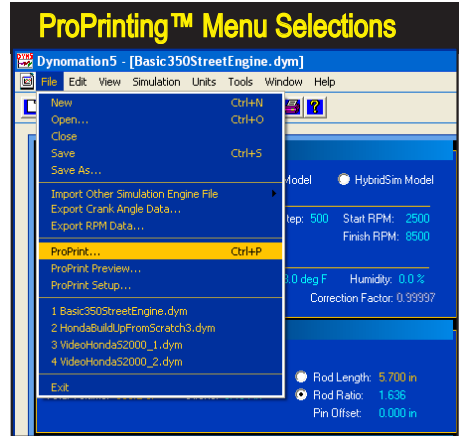

ProPrinting™ setup and function are controlled by three choices from the program File menu:

ProPrint (Requires Internet Explorer to be set as your default browser)

Selecting ProPrint from the FILE menu starts the process of building the HTML document and, when completed (takes a few seconds), opens the standard Windows *Print* dialog box that allows you to *Select* a printer, provides access to printer *Properties*, and sets the print *Range* (by entering **X-Y** in the *Print Range* field, with **Y** the starting page and **X** the ending page). Printing can be started (or canceled) from this dialog box.

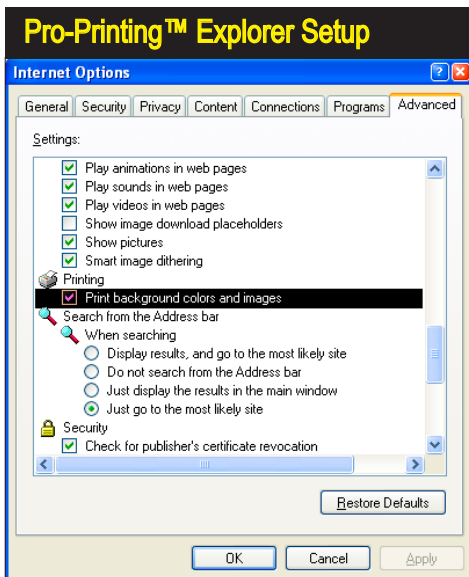

Some browsers, like the deprecated *Internet Explorer*, do not print “background graphics” by default. This can prevent the printing of data table background colors in *ProPrinting*™ reports. To enable full-function printing, open the *Options* choices (typically located in the *Tools* or *Setup* menus—you may have to choose the *Advanced* option—and enable *Print background colors and images*).

ProPrinting™ Features

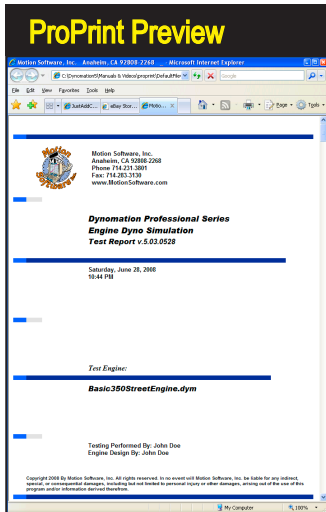

Print Preview displays your ProPrint report in your Internet browser for you to review (works with most browsers). The first page is shown, and you can scroll through the rest of the document with the scroll bar. Select **Print** from the **File** or **Settings** menu to send the report to your printer.

ProPrint Preview—(Works with IE, Chrome, FireFox, Opera and other browsers)

Opens the ProPrint report in your default Internet browser, with page 1 at the top. Uses the scroll bar in your browser to move (down) through all pages in the report. You can print the report by opening the **Print** or **Print Preview** choices from the **File** or **Setup** menus within your browser.

Note: If your browser supports the feature, you may be able to preview multiple side-by-side pages by opening the **Print Preview** function from within your browser.

ProPrint Setup

Opens a dialog that allows you to customize **Pro-Printing™** features. You can add your name, address, your company logo, specialized (copyright) text, a table of contents, and even a short or long glossary to your **ProPrint** report. Use the

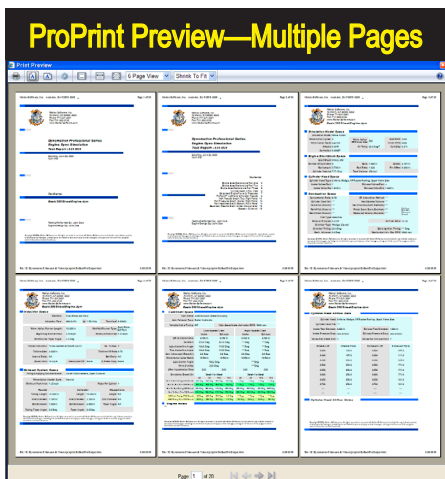

Some browsers support a multiple page **Print Preview**. Here is a six-up display; you may be able to select any number of pages you wish.

ProPrinting™ Features

Pro-Printing™ Setup

ProPrinting™ displays the results of any engine simulation in a professional, multi-page test report. Use the **Pro-Printing™ Setup** dialog box, from the **File** menu, to enable and customize **Pro-Printing™** features. You can add your name, address, your company logo, specialized text, a table of contents, and even a short or long glossary to your **ProPrint** report. Use the **Save** button to save your preferences, which will be applied to all subsequent engine simulations. The files for the **Default Logo.bmp** and the **DefaultCopyright.txt** are located in **Dynomation6/Manuals & Videos/ProPrint** or the **DynoSim6/Manuals & Videos/ProPrint** subdirectory. You can modify these files to suit your requirements.

Save button to save your preferences, which will be applied to all subsequent engine simulation reports. The files for the **Default Logo.bmp** (should be square with a size near 100 by 100 pixels) and the **DefaultCopyright.txt** are located in **Dynomation6/Manuals & Videos/ProPrint** or **DynoSim6/Manuals & Videos/ProPrint** subdirectory (within your main program directory: **C:/Dynomation6** or **C:/DynoSim6**). You can modify these files to suit your requirements.

Custom ProPrinting™ Options

ProPrinting™ Setup will let you configure **ProPrinting™** features. If you activate **Include Logo**, the logo file **DefaultLogo.BMP** will be displayed and printed at the top of **ProPrint** pages. If you activate **Include @ Bottom Of Page**, the **Include** file (default is **DefaultCopyright.txt**) will be printed at the bottom of most pages.

The location of the **Default Logo.bmp** and **DefaultCopyright.txt** is the **Dynomation6/Manuals & Videos/ProPrint** or **DynoSim6/Manuals & Videos/ProPrint** subdirectory. You can modify the **Include @ Bottom Of Page** text to display any non-formatted text. Use a non-formatting word processor (we recommend **Windows Notepad**) to modify the text to fit your needs. Keep the length under about 50 words. The **DefaultLogo.BMP** file can be replaced with your own logo. Keep the file in a square, BMP graphic format, and it should be no larger than approximately 100 by 100 pixels.

ProPrinting™ Page Descriptions

The complete **ProPrinting™** report generated by the simulation consists of 22+ pages (you can decide what pages to print using the print dialog and the

ProPrint™ Features

ProPrint™ Setup dialog). The “core data” pages consist of four pages numbered 3 through 6, page 7 displays the simulation log, results tables are printed on pages 8 through 13, pages 14 through 17 are results graphs, finally, pages 18 through 22 provide a Glossary listing. Here is brief description of these pages:

Page 1 & 2—These pages are **Title** and **Table-of-Contents** pages. The *Table of Contents* page can be eliminated from the report by un-checking **Include Table Of Contents** in the *ProPrint™ Setup* dialog box (opened from the **File** menu within the simulation).

Page 3—Displays the first group of *Component Category* selections for the simulated engine (because of space considerations, they are not in the same order as shown on-screen).

Page 4—Displays the *Cylinder Head AirFlow* specifications for the simulated engine.

Page 5—Displays the *CamShaft Component Category* for the simulated engine.

Page 6—Displays the *Combustion* and *Exhaust Component Categories* for the simulated engine.

Page 7—This page or pages displays the Simulation Log (showing simulation issues and/or other generated data during the last engine simulation).

Page 8—Contains the first table of rpm-based simulation results, including Engine Speed, Flywheel Power and Torque, Indicated Power, Frictional Power, and Pumping Power.

Page 9—Contains the second table of rpm-based simulation results, including BASE Force On Piston, Piston Speed, Volumetric Efficiency (VE), Mechanical Efficiency, and Fuel Conversion Efficiency.

Page 10—Contains the third table of rpm-based simulation results, including indicated mean-effective pressures IMEP, BMEP, FMEP, and PMEP, plus Ignition Timing.

Page 11—Contains the fourth table of rpm-based simulation results, including Induction Airflow, Intake Manifold Pressure, Intake Port Pressure, Brake Specific Fuel Consumption (BSFC), and the Fuel Usage Rate.

Page 12—Contains the fifth table of rpm-based simulation results, including Total Retained Mass Flow, Lost Mass From Each Cylinder, Total Charge Loss, Charge Loss To Intake Reversion, Charge Lost To Exhaust Flow, Exhaust Spoilage.

Page 13—Contains the sixth table of rpm-based simulation results, displaying Nitrous Augmented Power and Torque.

Page 14—Contains a duplicate of the top-right graph of rpm-based simulation results as shown on the main program screen.

Page 15—Contains a duplicate of the center-right graph of crank-angle-based simulation results as shown on the main program screen.

Page 16—Contains a duplicate of the bottom-right graph of crank-angle-based simulation results as shown on the main program screen.

Page 17—Contains a duplicate of the left graph of crank-angle-based simulation results located under the Component Categories on the main program screen.

ProPrinting™ Features

Modifying HTML Format Files

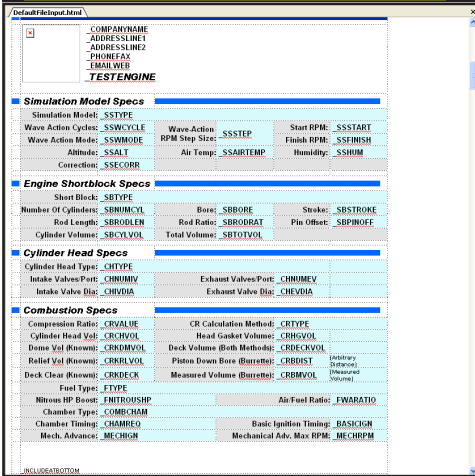

You can completely customize ProPrinting™ pages by editing the HTML *DefaultFileInput.html*. This file is the template that the simulation uses as the basis for ProPrint reports. The simulation key fields, such as _DATE, _TIME, etc., are replaced with data from the current engine test. Do not modify these keys or your reports may not include all simulation data!

Page 18 to 22—These pages contain a *Glossary Of Terms* that may help explain the “language” of engine simulations to your customers or others you may provide *ProPrint* reports.

ProPrinting™ Report Modifications (Optional, Advanced)

You can customize *ProPrinting*™ pages by editing the HTML *DefaultFileInput.html* (see *Important Note*, below). This *Input* file is the HTML template that the simulation uses as the basis for ProPrint reports. The simulation adds current engine data and sends the result as *DefaultFileOutput.html* to your default Browser. To make permanent changes to *ProPrinting*™ report pages, edit the *Input* file (make sure you make a backup copy of the original file first). You will notice key fields that begin with an underscore, such as _DATE, _TIME, etc. During processing, these data keys are located by the simulation and replaced with data from the current engine test. Do not modify these keys or your reports may not include all simulation data!

Important Note: Many HTML editors have their own methods of generating HTML code and may include characters and formatting that affect how reports are printed. If you are not familiar with HTML, don't attempt to modify the report Input File. Because of the unique characteristics of HTML, modifying ProPrinting™ HTML files is NOT supported by Motion Software, Inc.

Also, your modified *DefaultFileInput.html* **may be overwritten** when the simulation is updated using the *Motion Updater*, so keep a backup copy of your modified file to prevent losing your work.



SIMULATION ASSUMPTIONS

Applies To FE and WA Simulations, Except as Indicated

Dynomation6 and DynoSim6 closely simulate the conditions that exist during an actual engine dyno test. The software will predict the torque and horsepower that a dynamometer would measure while the engine and dyno are run through a programmed step test.

It is well known that engine power can vary considerably from one dyno test to another if environmental and other critical conditions are not carefully controlled. In fact, many of the discrepancies between real-world dyno tests are due to variabilities in what many assume are “fixed” conditions.

Among the many interviews conducted during the research and development of this simulation, dyno operators and engine owners readily acknowledged the possibilities of errors in horsepower measurements. Unless the dyno operator and test personnel are extremely careful to monitor and control the surrounding conditions, including calibration of the instrumentation, comparing results from one dyno cell to another (or even one test run to another) is virtually impossible.

Controlling these same variables in an engine simulation program is infinitely easier but, nevertheless, just as essential. Initial conditions of temperature, pressure, energy, and methodology must be established and carefully maintained throughout the simulation process. Here are some of the assumptions within this simulation that establish a modeling baseline:

Fuel:

- 1) The fuel is assumed to have sufficient octane to prevent detonation. Detonation is not modelled.
- 2) The air/fuel ratio is established by the user and can vary during the simulated dyno run if the user has entered A/F data in a user-defined “Table.” For more on Air/Fuel ratio modeling, see *Air/Fuel Ratio Modeling* later in this chapter.
- 3) Ignition timing can be set at MBT (Minimum advance for Best Torque) by clicking the Estimate Ignition Timing checkbox in the *Combustion Category*, however, if MBT not set, ignition timing (and power) may not be optimum.

Simulation Assumptions & Considerations

Environment:

- 1) Depending on the Atmospheric Standard in use (set in the Environment Group in the *Simulation Category*, inducted air is 77-degrees (F), dry (0% humidity), and of 29.23-in/Hg atmospheric pressure unless changed by the user.
- 2) The simulation assumes that engine, oil, and coolant have been warmed to operating temperature.

Methodology:

- 1) The simulated engine is put through a series of “step” tests, during which the load is adjusted to “hold back” engine speed as the throttle is opened wide. The load is adjusted to allow the engine speed to rise to the first test point. The engine is held at this speed at wide-open-throttle (WOT) and a power reading is taken. Then engine speed is allowed to increase to the next step and a second power reading is taken. This process continues until the maximum testing speed is reached.

Note: Since some engines, especially those with cam timing designed for all-out drag racing, are not able to run at full throttle under load at very low engine speeds, the power generated at some of the lower rpm points may register as zero.

- 2) Since the testing procedure increases engine speed in discrete steps, and engine speed is held steady during the power measurement, measured engine output does not reflect losses from accelerating the rotating assembly (the effects of rotational inertia in the crank, rods, etc.). These processes affect power in most “real-world” applications, such as road racing and drag racing, where engine speed is rapidly changing throughout the race.

Camshaft Modeling:

As detailed in the Component Category chapter, the simulation uses two distinct

Using Imported Cam Profile Data

Cam Type: Imported Profile

V-V-T Enable Display Low-Speed Lobe Display High-Speed Lobe

Cam Specification	Intake	Exhaust	Cam Specs	Intake	Exhaust
Gross	"Profile" Indicates Lobe		Angle:	110.0	110.0
Rock	Profile Data Is Being Used.		Line:	110.0	110.0
Gross Valve Lift:	0.901 in	0.573 in	Cam Conv. (/Ret):	0.0	0.0
Valve Lash:	0.000 in	0.010 in	Lobe Centerline:	110.0	
Net (Sim) Valve Lift:	0.461 in	0.469 in	Valve Overlap:	42.8	
Published Duration:	237.9	235.0	Lifter Accel Rate:	3.70 Auto	
W/A Lobe Data:	Profile	Profile	HS Lobe Activation:	5500 rpm	

Valve Events

	IVD	IVC	EVD	EVC
Seat-to-Seat	19.7	68.1	61.9	23.1
720 Based	240.2	609.1	119.1	292.1
0.0				

True Timing (Adv/R

">10-pnt" Buttons will convert Profile data to 10-Point modeling

If cam timing for any of the lobes used in the current simulation are based on an imported *Profile* data, the *W/A Lobe Data* field display will switch from *10-Point* to *Profile* in the *CAMSHAFT* category. *Profile* data is the closest match to “real-world” camshaft profiles and offers the highest modeling accuracy. *10-Point* data doesn’t follow “true” cam profiles as well as *Profile* data, but has the advantage of being extremely flexible by allowing modifications to any cam-timing events and lift data.

Simulation Assumptions & Considerations

types of cam data for simulation modeling: 1) *10-Point Timing* and 2) *Lobe-Profile* lift data. Profile data is the closest match to a specific “real-world” lobe profile and offers the highest modeling accuracy. 10-Point data, while not as precise in modeling a specific lobe, has the advantages of being extremely flexible by allowing modifications to any cam-timing events and lift data; very helpful during the process of finding optimum cam timing for specific applications.

Air/Fuel Ratio Modeling:

Air/Fuel ratio has a strong influence on engine output. Fuel and oxygen molecules combine during combustion to produce heat, pressure, and residual gases. If all the carbon and oxygen atoms combine within the cylinder during combustion, no carbon monoxide or unburned hydrocarbons will remain. This “complete burning” is called stoichiometric combustion (and is a theoretical optimum condition that is not achieved in the real world). The air/fuel ratio that allows complete combustion is called the *stoichiometric air/fuel ratio*, and it is approximately 14.6:1 for gasoline. However, for maximum power a richer mixture is required, often around 12.5:1.

Note: The air/fuel ratios for maximum power for all fuels modeled by the simulation are listed in the **Air/Fuel Ratio** drop-down menu within the **Combustion** category.

Finally, when *Nitrous-Oxide* augmentation is used with either Gasoline or Methanol, additional fuel flow is required to maintain the correct air(oxygen)/fuel ratio. The

Air/Fuel “Map”

The simulation can model a varying air/fuel ratio throughout the simulation rpm test range. The *Air/Fuel Ratio Map* is available by selecting *Table* from in the *Combustion* category.

Simulation Assumptions & Considerations

Forced-Induction Modeling Techniques



The simulation uses the greatest care in modeling the actual processes involved in forced-induction systems, however, the level of complexity is quite high. The bottom line: Trying strange values or combinations will probably generate less accurate results. Also, don't forget the adage "Garbage in; garbage out," as the more accurate the simulation inputs reflect the actual engine buildup, the better the results.

simulation will automatically increase the fuel volume to maintain the air/fuel ratio displayed in the **Combustion** category.

Note: The fuel flow rate is shown in the **ProTools Table** display, along with Brake Specific Fuel Consumption (BSFC).

Forced-Induction Modeling:

There are three basic types of supercharger models available: the *Roots/Screw Model*, *Centrifugal Model*, and the *Turbocharger Model*. In addition, there is also an intercooler model that can be coupled with any of the supercharging systems. Each of these forced-induction models function in unique ways.

Three basic steps are performed within all of these forced-induction models: 1) Calculation of the rotational speed of the compressor, 2) Determination of the degree of air pressurization, and 3) Calculation of the effects of pressurized air on engine output. This process is very dynamic and complex, requiring constant feedback between the supercharger model and the simulated engine results (such as intake and exhaust airflow rates and temperatures, power consumed by the supercharger, heat generated during charge compression, etc.) to obtain accurate results.

Roots And Screw Superchargers:

Air compression within Roots and screw superchargers is calculated from the rated volume-per-rotation of the compressor impeller, the speed of the compressor, and the efficiency of the compressor (that constantly varies as a function of pressure, temperature, the design of mechanical components, and rotational speed). Roots and screw compressors are often driven by the engine crankshaft through a belt-and-pulley or gear-train system. So for this type of supercharger, the speed of the compressor impeller can be calculated directly from the rotational speed of

Simulation Assumptions & Considerations

the engine.

A Roots compressor does not strictly compress the air, but rather “moves” a fixed volume of air mass into the induction system for each revolution of the impeller. It is here the air is compressed: pressure is a result of the difference in the amount of air being pumped into the manifold relative to the amount of air being “swallowed” by the engine. Because this pressure is dependant on engine speed, it is possible for a Roots blower to function under vacuum conditions, or lower than ambient pressure, when the engine is drawing in more air than the compressor can supply. This typically occurs at low engine speeds.

Air compression in a screw-compressor system is very similar to that of a Roots, except that a screw compressor produces a small amount of internal compression. Peak pressure regulation in the induction system of Roots or screw superchargers is controlled with a pop-off valve that releases overpressure to the atmosphere. However, the most efficient operation is obtained by carefully selecting the correct blower displacement and belt ratios so that pop-off valve operation is not required.

The work required to pump additional air into the induction system comes with a price: The energy required to operate a Roots or screw compressor is substantial. The total power consumed depends on many factors, including ambient pressure, output pressure, temperature, compressor size, compressor friction, engine displacement, engine and supercharger rpm and operational efficiency.

Centrifugal Superchargers:

Like Roots/screw superchargers, a centrifugal supercharger is driven directly from the engine, usually by the crankshaft through a series of gears or pulleys and belts. The centrifugal supercharger consists of impeller that spins at high speed. The blades on the impeller draw-in and accelerate air into the supercharger housing. The degree of compression is dependant on the speed, the size of the impeller wheel, the wheel trim (the shape of the blades), and housing (often called the “scroll”) size. The pressure delivered to the engine is calculated from a “compres-

Roots Supercharger Simulation



Roots superchargers do not directly compress the air but rather pump a fixed volume of air into the induction system for each revolution of the impeller. Induction pressure is calculated as the difference in the amount of air being delivered to the intake manifold relative to the amount of air being “swallowed” by the engine.

Simulation Assumptions & Considerations

sor map” (consisting of measured performance data for that specific supercharger supplied by the manufacturer). The map contains information about the efficiency of the compressor at various pressures and speeds. Numerical data from the map is dynamically extracted during the simulation, and data points are interpolated to ensure the highest accuracy in predictions of induction temperature and pressure.

To limit maximum output pressure, typical centrifugal systems will use a pop-off valve that opens to release the additional pressure to the inlet side of the supercharger. The power consumed by a centrifugal compressor is not as great as it is for a roots or screw supercharger, but it is, nevertheless, a significant source of “lost” power.

Turbochargers:

Turbochargers are, basically, centrifugal superchargers with the compressor element connected to a turbine wheel driven by exhaust pressure. And while calculation of compressor speed is straightforward on a centrifugal supercharger, the same cannot be said for a turbocharger. Internal shaft speed (connecting the turbine and compressor wheels) is determined by (among other things) an analysis of exhaust flow, turbine wheel size, turbine housing shape, and the efficiency read from the turbine “map” (in addition to the compressor map!). Internal wheel speeds are based on a balance between the energy used to spin the turbine and the energy needed to compress incoming air. The simulation uses another “iterative” technique to find a shaft speed that balances energy generated with energy consumed.

The differences between the energy required to compress the incoming air and the energy available in the exhaust system is also the basis from which “backpressure” in the exhaust system is calculated. Backpressure robs the engine of its ability to purge itself of exhaust gasses and prevents efficient cylinder filling with fresh charge. To limit maximum intake manifold pressure and to minimize backpressure in the exhaust system, the turbocharger uses a pressure-limiting technique different from roots, screw, or centrifugal superchargers. When maximum boost pressure has been reached, excess exhaust-gas flow is diverting around the turbine through a

Air pumping in a screw-compressor system is very similar to that to a Roots, except that a screw compressor produces a small amount of internal charge compression and is typically more efficient.

Screw Supercharger Simulation

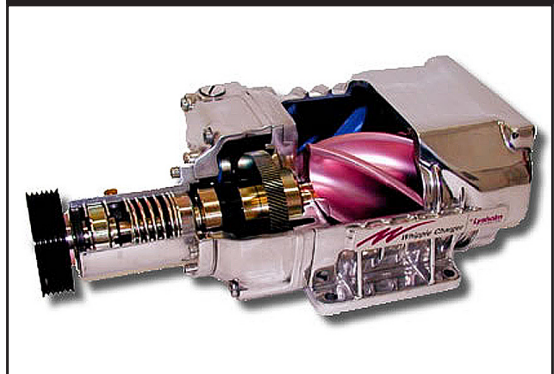

Simulation Assumptions & Considerations

Centrifugal Simulation

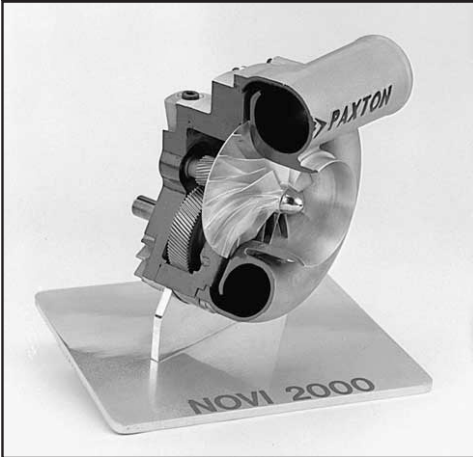

Centrifugal superchargers are driven directly from the engine, usually by the crankshaft through a series of gears and/or pulleys and belts. The centrifugal supercharger consists of impeller that spins at high speed. The blades on the impeller draw-in and accelerate air into the surrounding housing. In addition to shaft speed, the pressure delivered to the engine is also determined from data obtained from a “compressor map” (consisting of measured performance data supplied by the manufacturer for that specific compressor).

“wastegate” valve. Since diverted exhaust gasses no longer impinge on the turbine, the speed of the turbine can be effectively reduced and controlled, and the bypassed exhaust gas flow reduces backpressure and improves engine efficiency.

Note: The turbocharging algorithms used in the simulation were designed to model the properties of a “stable-state” turbo system. In other words, transient factors, like turbo “lag” that can occur when the engine is rapidly increasing in rpm, are not modeled. The simulation will provide a “steady-state” analysis of a turbocharged engine, that is, a power prediction when the engine reaches a steady-state condition on the dynamometer at each test rpm.

Intercoolers:

The temperature of the air entering the engine from a supercharging system is

Turbocharger Exhaust Wastegates

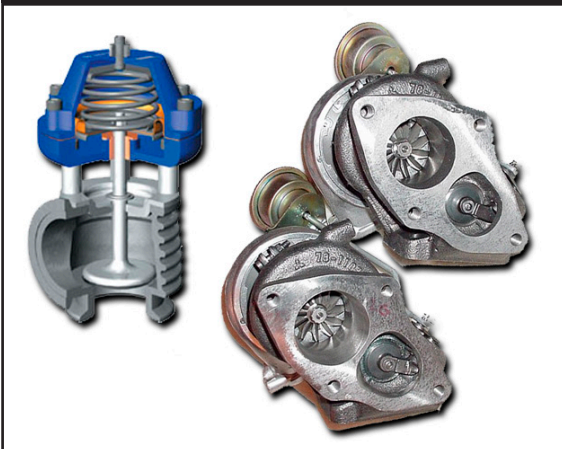

To limit maximum intake manifold pressure and to minimize backpressure in the exhaust system, turbochargers use a pressure-limiting technique different from roots, screw, or centrifugal superchargers. When maximum boost pressure has been reached, excess exhaust-gas flow is diverting around the turbine by a “wastegate” valve. Since diverted exhaust gasses no longer impinge on the turbine, the speed of the turbine can be effectively controlled, and bypassed exhaust gas flow reduces backpressure and improves pumping efficiency.

Simulation Assumptions & Considerations

Centrifugal/Turbocharger Simulation

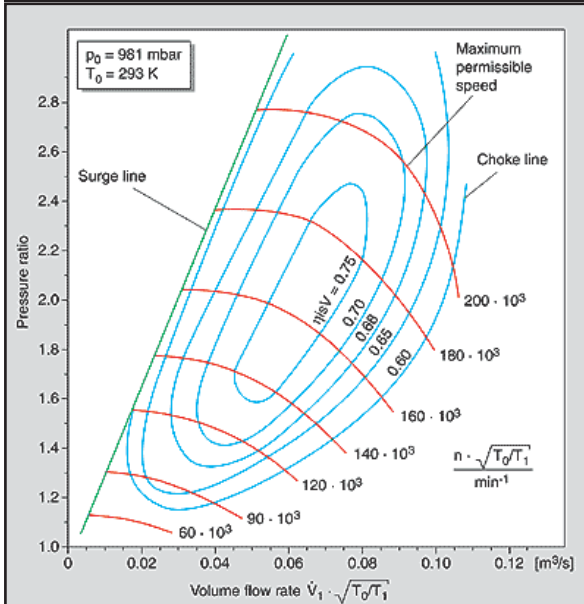

Both centrifugals and turbochargers use an efficiency “map” of the compressor, but turbochargers also use a second map for the exhaust turbine. Internal impeller speeds are based on an intricate balance between the energy used to spin the turbine and the energy needed to compress incoming air. The simulation uses an “iterative” process to balance energy generated with energy consumed to determine a stable internal shaft speed.

determined by several factors, including: 1) The *Gas Law* description of how air will always increase in temperature as it is compressed, and 2) The efficiency of the compressing device; the lower the efficiency, the greater the temperature rise.

Intercoolers, sometimes referred to as “aftercoolers,” are used to reduce the temperature of the compressed air exiting the supercharger before it enters the engine. Intercoolers are rated by their ability to absorb heat, and the ability to move air through the maze of passages within the intercooler (determines the amount of pressure reduction across the intercooler—some efficient intercoolers have pressure drop of less than 10%). The higher the intercooler efficiency, the more heat the intercooler removes from the compressed charge and the lower the pressure drop loss applied to the induction system.

Simulation File Compatibility

Motion Software users have created a nearly countless number of engine simulation files in several different file formats that have “evolved” as the simulation has improved over time. Many of these engine files are available on the Internet on enthusiast sites (with extensions of .DYN, .DYM, and .SDY). The simulation can now open engine files created in most previous Windows-based versions of Dynomation and DynoSim. If you are a user of the DOS-based Dynomation sold in the mid 1990’s, you can import these files, too.

Importing older engine simulation is easy, just use the *Import Other Simulation Engine Files* selection from the **File** menu (don’t try to “Open” these files directly;

Simulation Assumptions & Considerations

Intercooler Modeling



Higher induction temperatures, common on blowers with pressure ratios of 2.0 or higher, can cost horsepower and reliability. An Intercooler cools the inducted air the same way that heat is removed from the engine itself: with a radiator. Intercooling is the key to power and reliability in high-boost systems.

they must be *Imported*).

Note: You can install engines simulated in in this program into vehicles using DragSim and test 1/8- or 1/4-mile performance. And using FastLapSim you can test any simulated engine on virtually any closed-course track. Find out more about the other Motion Software simulations on www.MotionSoftware.com and on www.ProRacingSim.com.

Dynamation6 and DynoSim6 Simulation Features

The simulation can utilize two distinct simulation models for engine analysis: The *Filling-And-Emptying* (in DynoSim6) and the *Wave-Action* (both models are available in Dynamation6). Each of these simulation methods have their strong points, and like using the right tool for a specific job, selecting the best simulation model will help you find optimum component combinations in the shortest time. Refer to the chart on the next page for an overview the features and capabilities of this

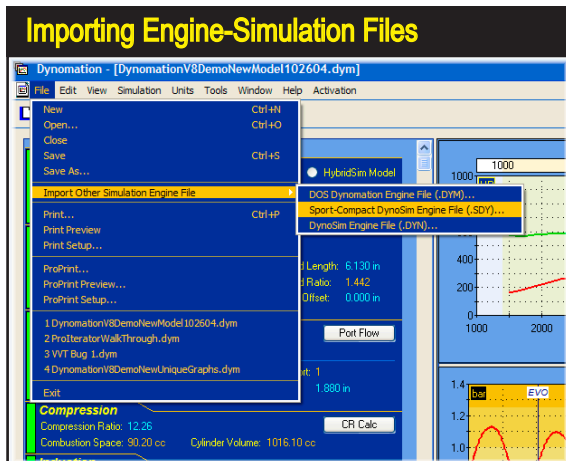

Motion Software have been used successfully for many years. Many of these engine simulation files are available on the Internet on enthusiast sites (search for .DYN, .DYM, SDY and .DXML files). The simulation can import engine files created in many earlier program versions, including older DOS-based Dynamation files.

Simulation Assumptions & Considerations

software.

Here is a brief description of the features in the table that follows:

(1) Forced-Induction Modeling: Adds sophisticated turbocharger, roots and centrifugal supercharger modeling. Display manifold pressures, modify belt ratios, pressure ratios, A/R ratios, intercooler efficiency, and more! Also includes wastegate modeling.

(2) Extended-Data Displays: Professionals often need additional data beyond power, torque, elapsed time, speeds, and other “basic” measurements to optimize

Dynomation6 Wave-Action And DynoSim6 Filling-And-Emptying Functional Differences

Motion Engine Simulation Capabilities	Filling-And-Emptying Simulation	Wave-Action Simulation
	DynoSim6 and Dynomation6	Dynomation6 Only
Dyno-Testing RPM Range	1000 to 14500 rpm	1000 to 14500 rpm
Bore Range Limits	2.00 to 7.00-in	2.00 to 7.00-in
Stroke Range Limits	1.50 to 7.00-in	1.50 to 7.00-in
Forced-Induction Modeling (1)	Yes	Yes
Extended-Data Displays (2)	Yes	Yes
ProPrinting™ Extended Dyno Reports (2)	Yes	Yes
ProData™ Tables (4)	Yes	Yes
Graph DataZones™ (5)	Yes	Yes
Prolterator™ Testing (6)	Yes	Yes
Analyze Area Under Power And Torque Curves (7)	Yes	Yes
Full Wave-Action Simulation (8)	No	Yes
Analyze Induction & Exhaust Pressure Waves (9)	Simplified Modelling	Full Analysis
Model Intake & Exhaust Runner Lengths & Taper Angles (10)	No	Yes
Megaphone/Normal Headers (11)	No	Yes
Transparent 3D-Engine Pressure-Analysis Display (12)	Yes	Yes
Graph Reticle Synchronized With 3D Engine Analysis (13)	Yes	Yes
Import Earlier Engines, Port Flow And CamFiles (14)	Yes	Yes
Import FlowPro Flow-Bench Files (15)	Yes	Yes
Import CamPro+, S96, CamDoctor Lobe-Profile Files (16)	Yes	Yes
Supplied With 3500+ Lobe-Profile Library (17)	Optional	Included
View 3D-Engine Mass-Flow Analysis (18)	Yes	Yes
Dual-Sim (Hybrid) Simulation (19)	No	Yes

Dynomation6 and *DynoSim6* use two distinct simulation models: The *Filling-And-Emptying* (used in *DynoSim6*) and the *Wave-Action* (both models are included in *Dynomation6*). Each of these simulation methods have their strong points, and like using the right tool for the job, selecting the best simulation model will help you find optimum component combinations in the shortest time and at the lowest cost. Refer to this chart for comparison of the features of these powerful engine simulations.

Simulation Assumptions & Considerations

engine and vehicle performance. To provide this data, internal physics models are extended, “in-depth” data is calculated and made available for graphic and table-based displays. Extended data types depend on the simulation, but examples include various engine pressures, frictional power consumption, trapped cylinder mass, etc.

(3) ProPrinting™: ProPrinting produces custom, full-color, multi-page test reports, including cover pages, tables of contents, your name and/or company name and logo, and even an optional glossary. ProPrinting produces an easy-to-read, comprehensive, professional printed test reports that you will be proud to display, present to customers, or just to keep a testing journal.

(4) ProData™ Graphic Displays And Tables: Includes the calculation and display of even more simulation data often needed by professional racers and/or engine developers.

(5) Graph DataZones™: DataZones allow you to display additional graph data and/or show ranges for target data values. DataZones can clearly illustrate dangerously high pressures, engine speeds, or almost anything you wish to highlight. DataZones can be displayed in any color(s), and you can automatically select a gradient range between beginning and ending colors.

(6) Prolterator™: *Iterative™* testing, an exclusive feature of Motion Software products, is an automated method of performing multiple tests and locating optimum combinations. The *Prolterator™* provides maximum flexibility in selecting components and setting up testing criterion. Search for optimum power/torque/acceleration, or locate the component combination that produces maximum “area-under-the-curve” for horsepower, torque, acceleration, or other variables. Once you have established the testing criterion, the *Prolterator* will begin a series of tests and display the best 10 results, all without user intervention.

(7) Analyze Area Under Data Curves: Part of the *Prolterator™*. While peak values of torque, horsepower, acceleration, and other simulation data focus on the “absolute maximum,” the areas under these curves represent the greatest “volume” of power or acceleration. Think of this area as the maximum horsepower throughout the rpm range. The *Prolterator* can search for the 10 best combinations that produce the greatest area under any portion of a selected data curve.

(8) Full Wave-Action Simulation: Finite-amplitude, wave-dynamics analysis using the Wave-Action, Method-Of-Characteristics mathematical model, Dynomation6 simulates the complex interactions of pressure waves in the intake and exhaust passages. Since these waves significantly affect the flow characteristics within engine ducting, a comprehensive analysis of pressure pulses and how they interact with runner length and taper angles is an essential element in accurately determining mass flow within the IC engine.

Simulation Assumptions & Considerations

(9) Analyze Induction And Exhaust Pressure Waves: Comprehensive graphs and data displayed in tables, synchronized to the graph-reticle position (indicating the instantaneous crank-angle), are provided in the Dynomation6 engine simulation. DynoSim6 also offers these same features, however, pressure waves are pre-calculated in DynoSim and so offer lower resolution than the wave presentation in Dynomation6. These pressure-wave data-sets are clearly displayed and can be compared with pressure pulses at different engine speeds or even with different engine designs.

(10) Model Intake/Exhaust Runner Lengths And Taper Angles: The “secrets” to engine performance often lie in the subtle elements of engine design, like the lengths and shapes of induction and exhaust passages. Dynomation6 allows anyone to test a wide variety of runner lengths and taper angles to determine, not only how these critical elements affect engine power throughout the powerband, but also to select optimum shapes for virtually any application.

(11) Megaphone And Normal Header Design Modeling: The Dynomation6 engine simulation models single exhaust pipes per cylinder, “standard” headers with collectors, and megaphone exhaust systems. All tubing lengths, diameters, and taper angles can be tuned for a variety of applications. Megaphone exhaust systems are often used in racing motorcycle applications, but are sometimes applied to performance automotive applications.

(12) Transparent 3D-Engine Pressure-Analysis Display: Provides a unique and powerful way to visualize the motion of pressure waves within a running engine. A cutaway view of a engine, rendered in real time using sophisticated 3D graphics, synchronizes valve and piston motions to the pressure-crank angle diagram. As you move the reticle across the diagram—to any crank angle within the 720 degrees of the 4-cycle process—the motion of the pistons, valves, and pressure waves are displayed. This unprecedented technology allows you to “see inside” the engine, providing the ultimate tool for pressure-wave understanding and analysis.

(13) Graph Reticule Synchronized With Engine Data: Moveable reticule lines on graphs that are synchronized with the underlying data. By moving the reticule over the graph, the exact data can be displayed.

(14) Import DynoSim & SC-DynoSim Engine, Cam, & Flow Files: Import and test engine, cam, and flow files from virtually all other Motion Software engine simulations. This makes testing and analysis much easier for those who have developed a library of data files from other Motion simulations.

(15) Imports FlowPro Flow-Bench Test Files: This simulation models intake and exhaust port flow from measurements taken at a wide variety of pressure drops and valve-lift points. To accommodate the professionals that uses Audie Technology software on their flow bench, it also directly reads FlowPro files.

Simulation Assumptions & Considerations

(16) Import CamPro, CamProPlus, S96, and CamDoctor Cam-Profile Files:

Supports the direct import of a number of commonly used cam-profile formats, including CamPro, CamPro+, S96, and Cam-Doctor files. A comprehensive Import dialog helps you assign centerline values and determine valve-open duration from lifter-rise measurements.

Motion Software offers a ProFile Library that contain 3500+ modern lobe profile files specifically designed for these engine simulations.

(17) Supplied With 3500+ Lobe-Profile Library:

The *Dynomation6* software package includes a separate CD with an extensive *Lobe-Profile Library* of more than 3500 modern lobe profile files from stock to ProStock applications! The Lobe-Profile Library is also compatible with DynoSim6, but is an optional item (can be purchased at any time).

(18) View 3D Engine Mass-Flow Analysis:

Includes a cutaway view of a engine allowing you to view the motion of the pistons, valves, and pressure waves within the engine. In addition, a 3D visualization of mass flow into and out of the cylinders is also provided.

(19) Dual-Sim (Hybrid) Engine Modeling:

Dynomation6 offers both the *Filling-And-Emptying* and *Wave-Dynamics* engine simulation models. These complimentary simulation models work together to provide the engine researcher with the greatest flexibility and modeling feedback. The *Hybrid* model combines the results from both simulations to best utilize the strengths of each modeling technique.

(20) Automatic Software Update—

Includes Motion's Automatic Software Update tool that automatically checks for updates (you can initiate a update check at any time by selecting *Check For New Version* from the **HELP** menu in the program). Users not only receive the typical bug fixes and minor enhancements, but often Motion Software, Inc., provides new features and modeling capabilities. More than 100 software enhancements have been made available **FREE OF CHARGE** for both *Dynomation* and *DynoSim* within the past few of years!



WAVE-DYNAMICS ANALYSIS

If you read the previous chapters in this Users Manual, you've discovered some of capabilities of this simulation and its ability to use gas dynamics analysis in IC engines. This chapter takes you considerably deeper into the theory of finite-amplitude waves and offers help in interpreting wave-dynamic results. We will examine how exhaust and intake runner lengths “tune,” you'll see the effects of blowdown, you'll discover pressure waves as they “bounce” off of the open and closed ends of passages, you'll uncover how stepped headers affect cylinder pressures, and much more.

DynoSim Note: *DynoSim6* analyzes pressure waves, similar to the *Wave-Action* model provided in *Dynomation6*, however, it does not resolve runner lengths, passage dimensions, minimum and maximum areas, etc. Pressure waves in *DynoSim6* are pre-calculated, substantially increasing the speed of the simulation, but because passage dimensions and the instantaneous states of pressure waves are not a part of the analysis, *DynoSim6* is not able to determine all of the complexities that can occur in unique and racing engines. Despite this, the advanced pressure-wave algorithms used in *DynoSim6* are remarkably accurate in modeling stock and high-performance engines of all types, even Diesel engines!

A review of this chapter will broaden your understanding of the displayed pressure waves and particle flows illustrated in the graphs in *DynoSim6*. Using this knowledge will allow you to take advantage of many of the insights that *Dynomation6* users gain from a look “inside” a running engine.

THE IC ENGINE: AN UNSTEADY FLOW MACHINE

The air/fuel mixtures and exhaust gasses that move within the passages of the internal-combustion (IC) engine behave in an *unsteady* manner. In other words, the gases are constantly changing pressure, temperature, and velocity throughout the four-cycle process of induction, compression, expansion, and exhaust. For example, when the intake valve is closed, the gas velocity at the valve is zero. When the valve begins to open, a difference in pressure between the cylinder and the port begins to

Wave-Dynamics Analysis

accelerate gas particles into (or out of) the cylinder. This gas motion—and all other gas particle motion within the engine—starts and stops, squeezes and decompresses, heats up and cools down. To analyze and simulate these actions, designers and programmers must rely on the discipline of *Unsteady Gas Dynamics*. A basic knowledge of this subject and the ability to visualize (and calculate using simulations) wave interactions inside the IC engine is probably the single most important “tool” available to the modern engine builder.

The application of Unsteady Gas Dynamics does not require that we cover the development of gas-flow equations (thank goodness!!), but a general description of the mechanisms that apply to the IC engine are essential.

Acoustic Waves Vs. Finite-Amplitude Waves

The sounds we hear around us are actually small pressure disturbances in the air. We call these pressure “pulses” *acoustic waves*. The pressure amplitude (volume) of these waves is very small. As an example, the volume at which you will begin to experience pain from sound occurs around 120 decibels and creates a peak pressure of only 0.00435psi above the ambient, undisturbed air. Since sea-level air pressure (barometric pressure) is about 14.7psi, then the *pressure ratio* at which sound become painful is:

$$Pr = P / Pa$$

where

$$P = 14.7 + 0.00435 \text{ Psi}$$

$$Pa = 14.7 \text{ Psi}$$

so:

Finite Amplitude Wave Strengths

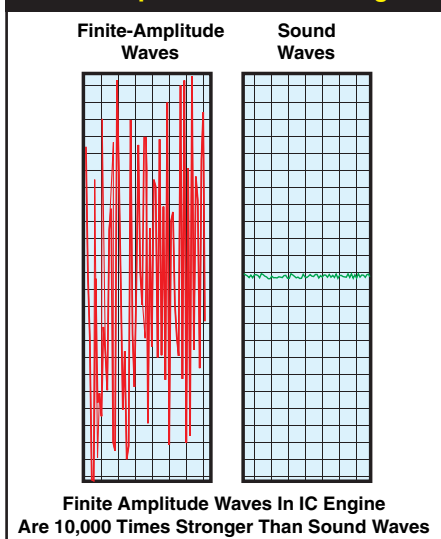

Very loud acoustic waves create small pressure disturbances. *Finite-amplitude waves* found in the IC engine, however, create pressure disturbances almost 10,000 times greater than painfully-loud sound waves. Because of this huge difference in amplitude, finite-amplitude waves exhibit their own, unique characteristics, requiring a radically different mathematical analysis than sound waves.

Wave-Dynamics Analysis

$$Pr = 14.70435 / 14.7$$

Pr = 1.0003 or a 0.03% Increase In Pressure

that's three one-hundredths of one percent increase over atmospheric pressure!

Obviously, very “loud” acoustic waves create very small pressure disturbances. There are waves that produce substantially higher pressure ratios than even loud sound waves. These powerful energy-charged waves are called *finite-amplitude waves*. Pressure disturbances at these higher intensities can be found in the induction and exhaust passages of the IC engine. Remarkably, pressure ratios of 2.5 can be readily measured (that's a pressure ratio almost 10,000 times greater than painfully loud sound waves—certainly something you would never want to “hear”). This enormous difference in intensity between acoustic and finite-amplitude waves gives some insight into why the misnomer “acoustic theory” (still commonly used) for calculating optimum “tuned lengths” of intake and exhaust passages is misapplied (more on this later).

Compression And Expansion Waves

Finite-amplitude waves take two forms within the IC engine: *Compression* and *Expansion*. The *Compression* wave is a positive pressure disturbance that will always have a pressure ratio greater than one. The *Expansion* wave is a strong drop below ambient pressure, and therefore will always have a negative pressure ratio (less than one). Expansion waves are known by other names, such as “rarefaction waves” or “suction waves,” however, they all refer to the identical phenomenon.

Compression and expansion waves act in similar—but uniquely different—ways as they move through IC engine passages. Understanding how these waves move and how they interact with their surroundings is an important part of understanding how gasses move inside the IC engine. The first piece of the puzzle is illustrated in **Figure-1**. This drawing depicts a positive compression wave traveling from left to right

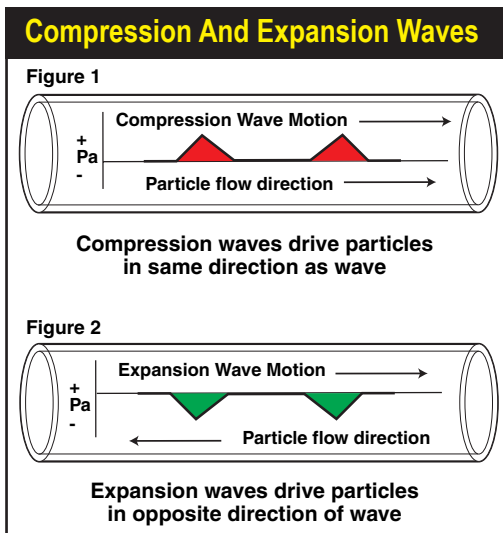

As positive compression waves travel from left to right through a pipe (top), they drive gas particles in the same rightward direction. When expansion waves (lower) travel from left to right, they pass through gas particles in the pipe and propel them in the *opposite* direction, in this case, leftward.

Wave-Dynamics Analysis

through a pipe. As the pressure waves travel rightward, they drive gas particles in the same rightward direction. However, the velocity of the gas is considerably slower than the speed of the pressure waves. There are many analogs to this in everyday life. For example, consider logs that are pushed ashore by waves on the surface of a lake. The waves wash through floating logs driving them forwards but at a much slower rate than the speed of the waves.

An expansion wave is shown in **Figure-2**. This low-pressure wave is also traveling from left to right. However, as it passes through gas particles, its lower pressure gradient draws particles toward the wave, in effect, driving particle flow in the *opposite* direction, in this case, leftward.

In addition, both compression and expansion waves change their character when they encounter sudden transitions in area. Area changes within engine ducting occur at an open end, a closed end, or at transition to smaller or larger diameter passages. Perhaps the most familiar area change occurs at the end of an exhaust header pipe. The primary tube either abruptly ends at the opening to the atmosphere, or it empties into a larger-diameter collector that opens to the atmosphere several inches downstream. Beyond this very visible (and easily heard) pipe transition, there are many other changes in area within engine ducting. For example, where the intake runner transitions into the manifold plenum or directly into the atmosphere (in the case of injector stacks), a substantial area change is produced. Furthermore, the intake and exhaust valve sits at the end of a pipe that is either closed or partially open, again creating significant changes in areas. What happens when a finite-amplitude wave reaches one of these area transitions?

First, let's examine a case where pressure waves reach the closed end of a pipe. **Figure-3** illustrates a positive-pressure compression wave striking the closed end of a passage. It returns with its original profile intact. The only change is that the pressure wave is now moving in the opposite direction. Consider how this affects gas particle motion. When the compression wave travels rightward, it nudges the gas particles toward the right. After reflection, the compression wave nudges the particles

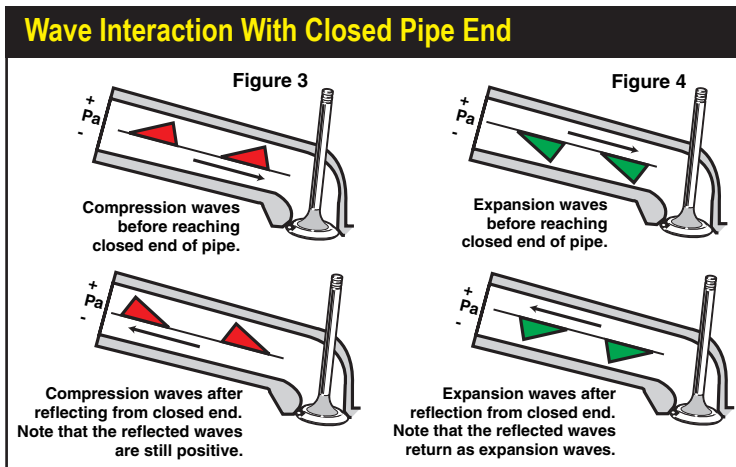

Positive pressure compression waves striking the closed end of a passage return with their original profile intact. Expansion waves behave similar to compression waves. Net particle motion is zero.

Wave-Dynamics Analysis

A leftward-moving compression wave is reflected as a rightward-moving expansion wave when it reaches the open end of a pipe (figure 5). Particle movement is leftward in both cases. A leftward moving expansion wave is reflected as a rightward-moving compression wave (figure 6). Particle movement is rightward in both cases.

Wave Interaction With Open Pipe End

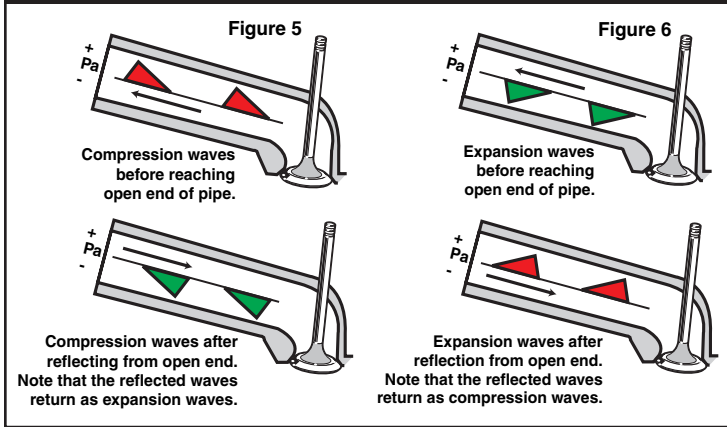

leftward. The gas particles are returned to their original position; there is no net flow in the pipe. This is exactly what you would expect to find in a pipe that is closed at one end! **Figure-4** depicts an expansion wave as it travels rightward within the same closed-end pipe. Behaving similar to a compression wave, the reflected leftward moving wave remains an expansion wave with the same profile. Net particle motion is, again, zero.

Now let's explore the interesting actions of finite-amplitude waves as they move within an open-end pipe. **Figure-5** shows the arrival of a compression wave at a transition to a larger area. Notice that leftward-moving compression wave is reflected as a rightward-moving expansion wave. This has fascinating implications for particle movement. Initially, while the compression wave traveled leftward, it helped propel gas particles in the same leftward direction, toward the pipe end. When the expansion wave is created and it begins rightward movement, it continues to drive particles in the leftward direction (because expansion waves move particles in the opposite direction of wave travel). *Finite-amplitude compression waves moving toward the open end of a pipe provide a "double assist" to particle movement in the same direction.*

Simple Kadenacy Theory

Incorrect "Kadenacy" Theory For Exhaust Gas Dynamics

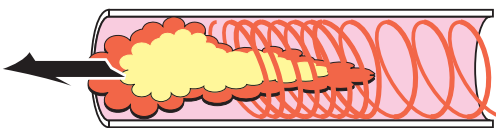

High Pressure "Slug" (similar to compressed spring)

Low Pressure Follows (similar to expanded spring)

In an effort to explain gas flow in the exhaust system, it was believed that when the exhaust valve opened, a high pressure "slug" of gas blasted out of the port and down the header pipe. As this slug moved, it created a low-pressure "wave" behind it. This Kadenacy theory was conclusively disproved nearly 60 years ago. Despite this, it is still widely believed by engine "experts" to this day!

Wave-Dynamics Analysis

Now consider the same open-end pipe, but this time a leftward moving expansion wave is illustrated in **Figure-6**. As the expansion wave approaches the open end, it moves particles in the opposite direction, away from the end of the pipe. When the expansion wave reaches the pipe end, it is reflected as a compression wave and moves rightward, driving particles in the same rightward direction. So *expansion waves “double-assist” particle movement away from the open end of the pipe.*

These pressure wave phenomena, particularly as they apply to the exhaust system, were not understood until the 1940s. Until that time, it was assumed that a high-pressure gas particle “slug” moved through the header pipe and created a vacuum behind it that helped to draw out residual gases. This “Kadenacy” theory—named after its inventor—is analogous to the compression waves traveling through a “Slinky™” coil-spring toy; a tight group of coils (representing high pressure waves) moves along the spring followed by a more open group of coils (representing low-pressure waves). Despite the fact that this theory was conclusively proven to be incorrect over 60 years ago, it is still believed by some engine “experts” to this day!

Pressure Waves And Engine Tuning

The goal of the high performance engine builder is to tune the lengths of IC engine passages so that the reflected waves reach the cylinder at the most effective times, either assisting exhaust-gas outflow or induction-charge inflow. If there ever was a statement that qualified for the adage “easier said than done,” then this is it! There are many factors that affect the arrival of these waves. A short list would include valve timing, cam profiles, piston speed, pipe lengths, valve discharge coefficients, and cylinder blowdown pressures. To make matters worse, the peaks of finite amplitude waves travel faster than the base of the waves, causing wave profiles to distort as they travel through engine passages (see **Figure-7**). This can ultimately cause the waves to “tumble” over themselves, forming shock waves and converting their energy into heat. All of these complex interactions occur simultaneously and make it easy to see why the simple *acoustic* formulas that engine builders have traditionally used to determine “tuned lengths and pipe diameters” are not applicable.

There are only two practical methods to determine effective pipe lengths and

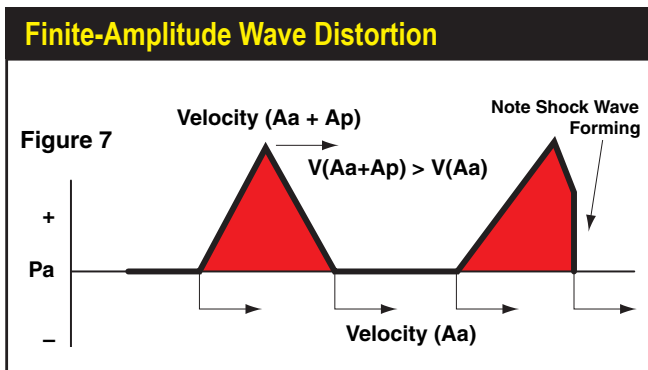

The peaks of finite amplitude waves travel faster $V(Aa + Ap)$ than the base of the waves (Aa) acoustic velocity, causing wave profiles to distort as they travel through engine passages. This can ultimately cause the waves to “tumble” over themselves forming shock waves and converting their energy into heat.

Wave-Dynamics Analysis

diameters. One is to build the engine, install it on a dyno, connect pressure-reading transducers to the intake and exhaust passages and cylinders and record pressure data. By analyzing these pressure signatures and running a series of tests with various component combinations, the engine builder can develop an effective engine for the desired purpose. The problem with this method is the associated high costs in time and money. Another method of finding effective pipe lengths and “zeroing in” on optimum component combinations is to *simulate* the pressure waves and particle flow that occurs within the IC engine. The problem with this method was that, until recently, an affordable four-cycle, pressure-wave simulation program for personal computers simply did not exist.

In 1993, V.P. Engineering introduced Dynomation DOS, a PC computer program that applied the *Method Of Characteristics* mathematical solutions to the analysis of finite-amplitude waves within the 4-stroke racing engine. This early DOS version of Dynomation allowed engine builders to analyze pressure-waves and particle-flow motions (although at a snail’s pace). It displayed intake, exhaust, and cylinder-pressure curves along with intake and exhaust flow velocities and directions. The experienced engine builder used this information to develop better component combinations.

Now with introduction of *Dynomation6* from Motion Software, this powerful simulation method runs under Windows about 10 to 100 times faster, displays simulation results in custom graphics, includes 3D engine renderings, calculates mass flow in ports and passages, includes more sophisticated modeling, forced induction, multiple fuel modeling and much more.

PRESSURE-TIME HISTORIES

The direct measurement of engine pressures can reveal a great deal about en-

Pressure-Wave Measurement

Figure 8

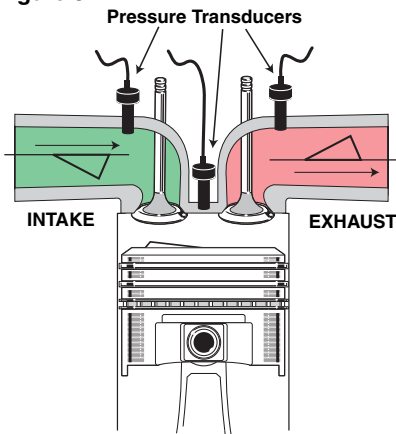

Engine pressures can be directly measured with special transducers precisely positioned in the intake and exhaust passages and directly in the cylinders. The intake and the exhaust transducers are often located near the valves. The cylinder pressure transducer is located in the cylinderhead, protruding into the combustion chamber.

Wave-Dynamics Analysis

gine function. An analysis of engine pressures—throughout the complete four-cycle process—reveals the combined effects of all mechanical components, plus the thermodynamic effects of heat transfer, the results of all finite-wave interactions, and mass flow of induction and exhaust gasses within the engine. The measurement of these pressures requires the precise placement of pressure transducers in the intake and exhaust passages, and directly in the cylinders of the engine. **Figure-8** shows typical

Pressure Crank-Angle Diagram

Figure 9 Pressure Crank-Angle Graphs

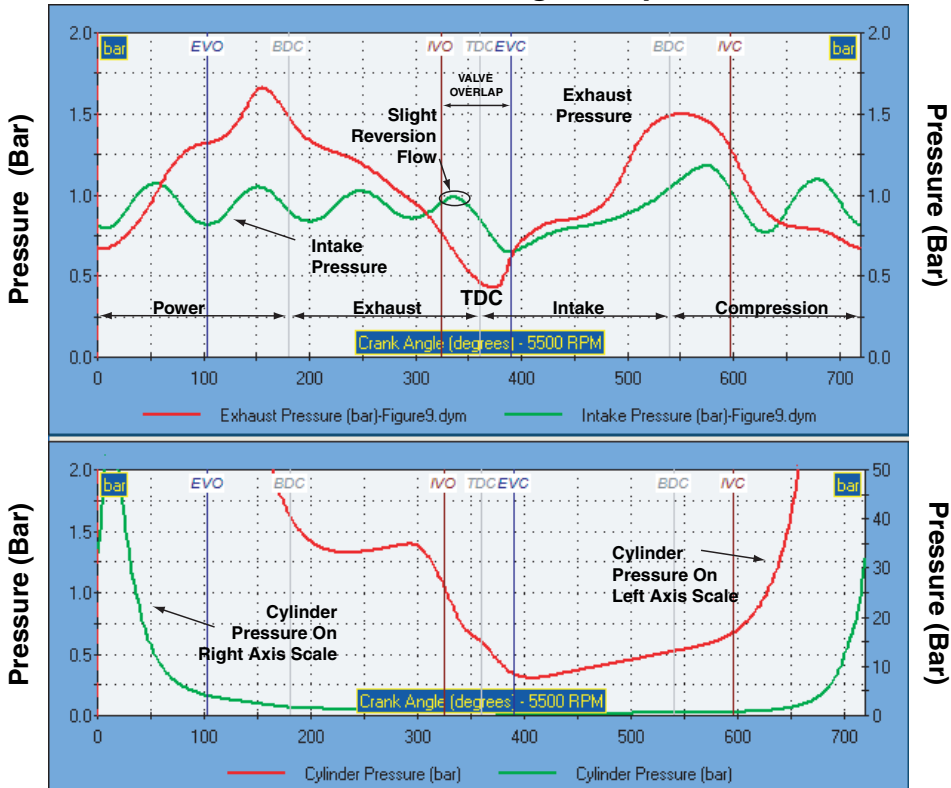

These graphs are called pressure crank-angle diagrams. They trace out the pressures measured throughout all four engine cycles, as if recorded by (simulated) transducers located in the ports and cylinders (see photo, previous page). In the upper graph, notice when the exhaust valve opens (EVO). The formation of the primary exhaust pulse occurs. Cylinder pressure (shown in the lower graph) quickly falls and begins to approach exhaust port pressure. The pressure wave created at EVO returns to the cylinder during overlap. It creates subatmospheric pressures that stops reversion and helps induct fresh charge. If the exhaust system was designed correctly, the expansion wave will continue to assist induction flow throughout overlap until the exhaust valve closes (EVC).

Wave-Dynamics Analysis

locations. The intake and the exhaust transducers are often positioned close to the valves. The cylinder pressure transducer is located in the cylinderhead, protruding into the combustion chamber. The typical pressures recorded by these transducers is illustrated by the graphs shown in **Figure-9**.

This plot is referred to as a pressure crank-angle graph or pressure time-history diagram. The horizontal axis displays the crank position throughout the 4-cycles from 0-720 degrees. The zero point on the left of the graph starts at TDC just before the power stroke. Moving rightward, the first vertical line indicates the exhaust valve opening point (EVO), typically occurring slightly after 100 degrees. Continuing rightward, the next vertical line pinpoints intake valve opening (IVO) around 330 degrees. The exhaust valve closing point (EVC) occurs just under 400 degrees. The distance between the IVO and EVC graphically indicates the valve-overlap period. Around 600 degrees the intake valve closes (IVC). Finally, the diagram ends at 720 degrees with the piston back at TDC, marking the end of the compression stroke. The vertical axis of the diagram indicates pressure in terms of the pressure ratio (or *Bar*). A value of 1.0 represents standard atmospheric pressure (Pa). A value below this indicates subatmospheric pressure or *expansion* waves. Values above 1.0 are positive pressures above atmospheric and represent *compression* waves.

Note: The axis for the left and right vertical axis can be independently set. Notice that the left and right vertical axis on the upper graph both display up to 2.0 Bar, while the lower graph has independently scaled vertical axis set at 2.0 and 50.0 Bar, even though both axis display *Cylinder Pressure*. This allows a broader view of this widely changing pressure.

Now let's trace out the pressures measured throughout all four engine cycles (on **Figure-9**) as recorded by the three simulated transducers. Keep in mind that the pressures illustrated in this diagram reflect an engine that is "in-tune." (We'll explore out-of-tune pressures later.) When the exhaust valve opens (EVO), the formation of the primary exhaust pulse occurs. This high-pressure compression wave is created when the exhaust valve releases cylinder pressures (produced by the combustion of fuel and air) into the exhaust port and header pipe system. Cylinder pressure quickly falls and begins to approach exhaust port pressure. Before IVO, an intake pressure wave—created during the previous intake cycle—bounces between the closed inlet valve and the open end of the runner. This is shown by the oscillating wave (green) on the diagram alternately becoming an expansion and compression wave, with pressures centering around 1-Bar, or atmospheric. When the intake valve opens, cylinder pressure is almost always higher than the pressure in the induction system. For the short period of time that this pressure differential exists (intake pressure pulse indicated as *Reversion Flow* on graph), a reverse flow of exhaust gasses begins to move into the induction tract. Very little reverse flow generally occurs since piston speed is quite slow near TDC. During this time, the pressure wave that was generated when the exhaust valve opened reached the end of the header pipe and has now returned to the cylinder during the valve overlap period (between IVO and EVC) as an expansion wave. This wave creates subatmospheric pressures that stops reversion

Wave-Dynamics Analysis

and helps draw in fresh charge from the induction system before the piston begins to move down from TDC on the intake stroke. If the exhaust system (and several other engine parameters) are designed correctly, the expansion wave will continue to assist induction flow until the exhaust valve closes (EVC), as shown in **Figure-9**.

With the ending of the overlap period, the intake stroke begins in earnest. Throughout at least the first half of this period, inlet pressure closely follows cylinder pressure. Just before IVC a pressure surge or “hump” in the induction pressure begins to increase cylinder pressure. This surge is caused by a strong compression wave arriving from the induction system (created during the previous intake stroke), helping to “ram” fresh charge into the cylinder and minimize back flow. The arrival of this critically important compression wave is determined by runner length and shape, engine speed, and other factors. After IVC, the cylinder pressure continues to rise as the piston heads for TDC on the compression stroke.

Gas Flow Vs. Engine Pressures

Up to this point, you may have assumed that there exists a direct relationship between the pressures measured in the ports and the flow of gasses. Furthermore, you may have assumed that when a pressure transducer registers a compression wave within a passage that opens on the right, gas flow would move in a rightward direction. In some instances gas flow does not coincide with pressures. **Figure 10** will help shed some light on this confusing issue. As compression **Wave-1** moves rightward it propels gas particles toward the right. A second compression wave, **Wave-2**, moves leftward in the same passage and propels gas particle toward the left. When **Waves 1** and **2** pass through each other they form the superposition **Wave-3 (1 + 2)**. Gas particles that were being propelled towards each other by the separate waves

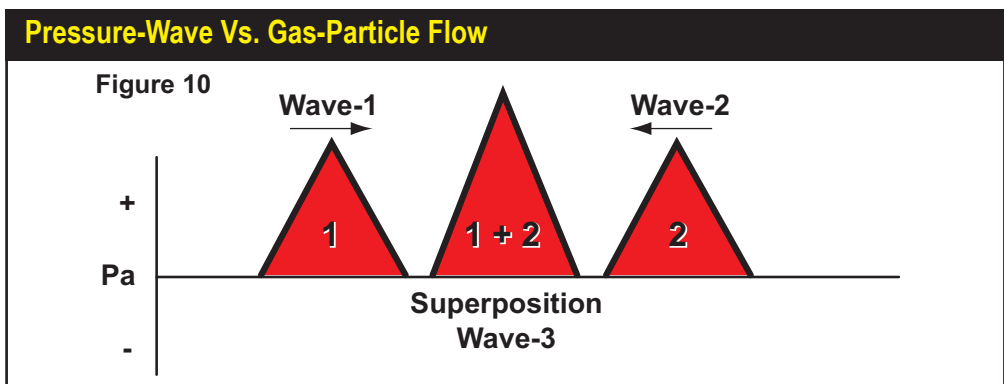

A direct relationship between measured pressures and the flow of gasses within the ports does not always exist. Consider compression Wave-1 moving rightward and propelling gas particles toward the right. Wave-2 moves leftward in the same passage and propels gas particles toward the left. When Wave-1 and Wave-2 pass through each other they form the superposition Wave-3 (1 + 2). Gas particles come to rest, but a pressure transducer measuring this “new” wave would register a significant pressure increase.

Wave-Dynamics Analysis

Pressure-Wave Measurement

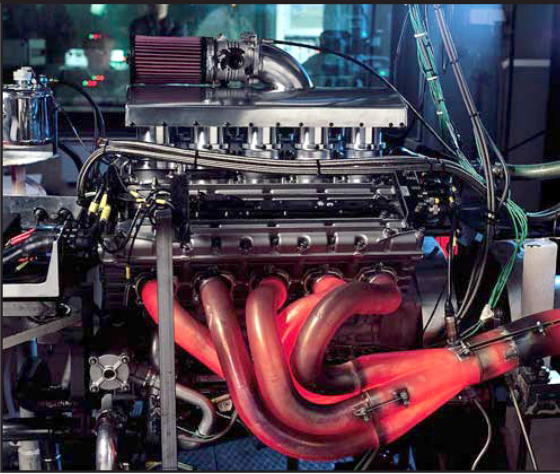

The first part of effective intake tuning begins with good exhaust system tuning. When the exhaust valve opens it generates a powerful positive pressure wave that travels to the end of the header pipe and returns to the cylinder as a strong expansion wave. When the timing is right, this suction wave will arrive during valve overlap and draw out burnt gases while starting the inflow of fresh charge, optimizing horsepower.

will collide and come to rest within **Wave-3**. A pressure transducer measuring this “new” wave will register a pressure increase. It would be easy to assume that the higher pressure represented an increase in particle velocity.

This phenomenon makes the interpretation of pressure data difficult and easily misleading. Fortunately, Dynomation6 and DynoSim6 also calculate and display *particle-flow velocity and direction* in addition to pressures for each degree of crank rotation. With the display of port flow velocities, the simulation provides the engine builder a comprehensive picture of port and cylinder pressures, intake and exhaust particle flow velocities, and the direction of that flow.

INTAKE TUNING

The first part of effective intake tuning begins with good exhaust system tuning. As mentioned previously, when the exhaust valve opens it generates a powerful positive pressure wave that travels to the end of the header pipe and returns to the cylinder as a strong expansion wave. When the timing is right, this suction wave will arrive during valve overlap and draw out burnt gases while starting the inflow of fresh charge. This scavenging effect lowers cylinder pressures just before the exhaust valve closes, early in the intake stroke. After EVC, the piston begins to move rapidly down the bore and when it reaches maximum speed, between 73- and 82-degrees after TDC, the rapid increase in cylinder volume will “yank” down the already low pressure in the cylinder. On the pressure-crank angle diagram this will occur between 400- and 440-degrees and is usually the lowest point on the cylinder pressure trace. This sudden drop in pressure generates a strong suction wave that travels toward the open end of the intake runner where it is reflected as a positive compression wave. Depending on the length of the runner and the speed of the engine, this compression wave will return to the cylinder just before the intake valve closes. The arriving

Wave-Dynamics Analysis

Reflected Waves In Intake Port

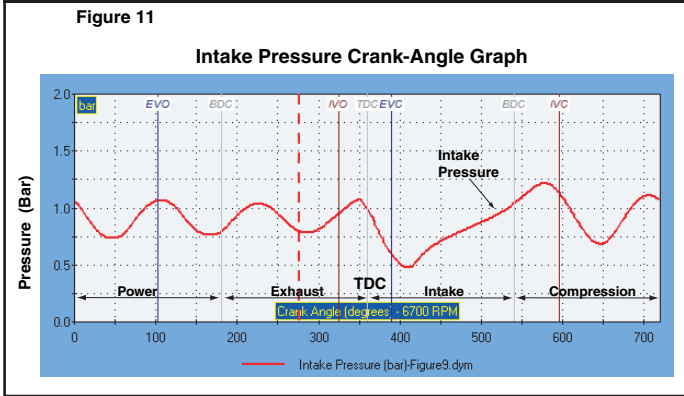

Typical intake pressures throughout the full 720 degrees of crankshaft rotation show how each successive wave reflection returns with slightly lower peak pressure. To gain the greatest benefit from the reflected wave at peak engine speed, it is often best to tune the induction system to utilize the *second or third* returned pulse.

intake compression wave provides two benefits: 1) As the wave moves through the port it pushes particles in the same direction, helping to fill the cylinder. When the compression wave reaches the intake valve just before IVC, 2) the positive pressure overcomes the buildup of pressure in the cylinder created by the piston moving up the bore on the early part of the compression stroke. This forces additional charge into the cylinder while delaying charge reversion until just before intake valve closes (an effect sometimes described as ram tuning). This complex series of tuning events adds the winning edge to many racing engines, but the exhaust system, induction system design, and all cam timing events must be synchronized to produce these effects.

When this critical synchronization is lost, intake charge will be driven back into the induction system before IVC. And reversion is a power killer. The simulation can accurately predict when this will occur in the port-flow velocity diagram (we'll provide specific examples of this later in the chapter).

After IVC the strong expansion wave created by the now completed intake stroke oscillates between the pipe end and the closed intake valve. It changes its sign from expansion to compression each time it encounters the open end of the runner. **Figure-11** shows the typical intake pressure trace throughout the 720 degrees of crankshaft rotation. Each successive reflection returns with slightly lower peak pressure (displayed on the pressure graph from zero to IVO). To gain the greatest benefit from the reflected wave at peak engine speed, it is often best to tune the induction system to utilize the *second or third* returned pulse, since these retain the highest energy levels (engine timing and the physical length of the passages make it difficult to utilize the first pulse).

At lower engine speeds there will be more time for pressure reflections to return from the induction system, so additional waves will appear in the pressure crank-angle diagram. It is also possible to increase the number of pulsations at any given rpm by decreasing the length of the inlet runner. Similarly, a longer runner will decrease the number of pulsations since it takes more time for each pulse to return to the intake

Wave-Dynamics Analysis

valve. Optimum runner length to return a second pulse at IVC can be “ballparked” with the following equation:

$$\text{Second Pulse Length (inches)} = 108,000 / \text{RPM}$$

Note: This is an approximation of pulse length, as it varies with charge density, pressure, cam timing, runner temperature, and other factors.

This formula works best for engines that operate at relatively high rpm. Unfortunately, at lower engine speeds this equation predicts a tuned length that is too long to be practical. Under these conditions, tuning to the third, fourth, or possibly even the fifth returned pulse requires a much shorter and more-practical length runner. The famous “Long Ram” of the early 1960s was designed by Chrysler to boost lower-speed torque on some of its big-block engines (used in vehicles like the 300G). It was based on second and third pulse tuning, requiring runners so long the carburetors wound up positioned over the exhaust manifolds of the adjacent bank of cylinders. The runner lengths could have been much shorter if the manifold was tuned to the third or fourth induction pulses. Here are good approximations for runner lengths tuned for the third, fourth, and fifth returned induction pulse:

$$\text{Third Pulse Length (inches)} = 97,000 / \text{RPM}$$

$$\text{Fourth Pulse Length (inches)} = 74,000 / \text{RPM}$$

$$\text{Fifth Pulse Length (inches)} = 54,000 / \text{RPM}$$

Engine designers and builders can use these equations to obtain good initial estimates for further “fine tuning” in the simulation.

Because of the nature of “pulse-tuning,” an intake manifold goes in and out of tune as the engine accelerates through the rpm range. The manifold transitions from

Manifold Designed Using Dynomation

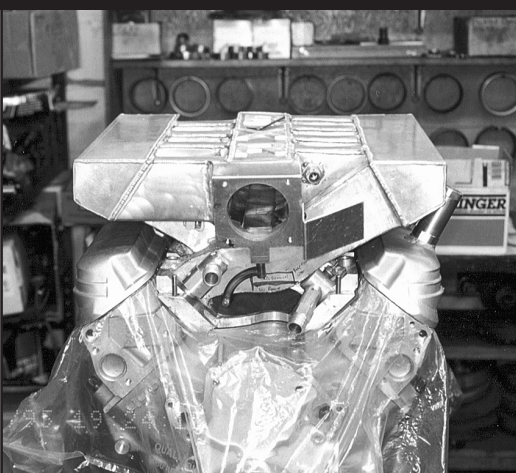

This custom intake manifold was designed with the help of Dynomation software. The manifold boosts low- and mid-range power on smallblock Ford engines. Dyno tests confirmed expected performance. Without simulation software, intake manifold design is strictly a trial-and-error process involving considerable time and money without any guarantee of success.

Wave-Dynamics Analysis

fifth, to fourth, to third, and then, possibly, to second pulse tuning at maximum engine speed. As the engine passes through each of these tuning points, the runner phases in and out of sync with the expansion wave created when the piston reaches maximum speed on the intake stroke. At lower speeds, when the engine tunes on the fifth or higher pulse, little benefit is derived from the weak returning pulse. However, by the time the engine reaches sufficient speed so that the third or second pulse arrives just before IVC, a substantial pressure differential strongly assists cylinder filling and prevents charge reversion.

Note: Since the second pulse delivers the strongest returning wave, the question arises: Why not use second-pulse tuning for all manifold designs? The answer is that the un-tuned gap between the second and third pulse is much greater than the gap between the third and fourth pulse. This means that engines using manifolds based on second-pulse tuning will have narrow, peaky, power bands, while third-pulse manifolds will tend to produce wider, although potentially lower, power curves.

Intake Runner Taper Angles

The taper angle of the inlet runner has a significant effect on the optimum tuned length. As runner taper angle increases, the returning pressure waves speed up, requiring a higher engine speed to regain the same level of “tune.” For example, a 13-inch runner with a 4-degree taper angle will tune at approximately the same engine speed as a 10-inch straight runner.

Straight runners often provide more power at lower engine speeds and work

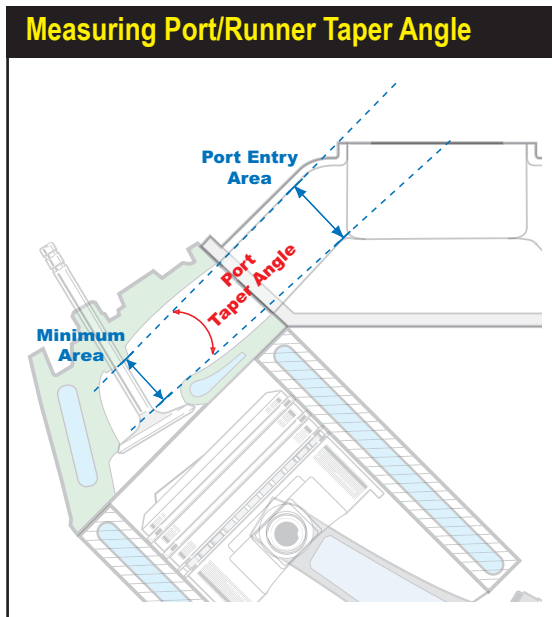

The taper angle of the inlet runner has a significant effect on the optimum tuned length and peak power. As runner taper angle increases, the returning pressure waves speed up, so a higher engine speed is needed to regain the same level of “tune.” There are several complex reasons why taper angles optimize power, but the most straightforward are: 1) A tapered port has a greater volume to “store” air/fuel charge and feed the cylinder during the main portion of intake stroke, and 2) A taper angle acts somewhat like a stepped-header for the induction system, generating a series of positive pressure waves that return to the valve and assist cylinder filling.

Wave-Dynamics Analysis

Effect Of Taper Angles

The taper angle of the inlet runner has a significant effect on the optimum tuned length. Inlet-runner taper angles can be varied in Dynation6 not only to develop better-functioning induction systems, but also to gain a better understanding of how this important tuning element affects engine power. Here is a comparison between straight runners (darker curves) and 3-degree taper runners. Notice that exhaust velocity is higher while intake velocity is lower. With tapered runners the engine produces more horsepower at peak engine speed.

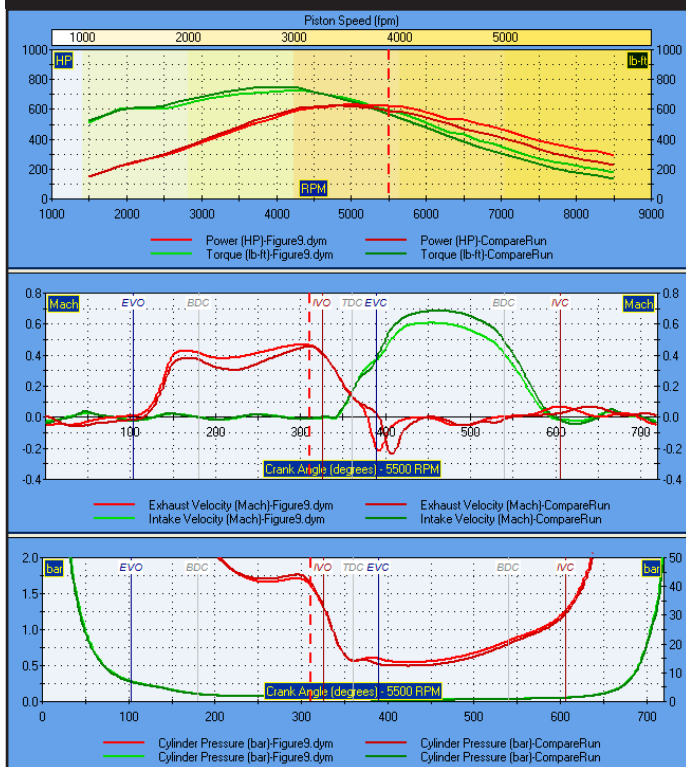

quite well for stock engines. However, to obtain peak performance from a high-speed racing engine, intake runners must incorporate a taper of 2 to 4 degrees (included). There are several complex reasons why taper angles optimize power, but the most straightforward are: 1) A tapered port has a greater volume to “store” air/fuel charge and feed the cylinder during the main portion of intake stroke, and 2) a taper angle acts somewhat like a stepped-header for the induction system, generating a series of positive pressure waves that return to the valve and assist cylinder filling.

Inlet-runner taper angles can be varied in Dynation6 not only to develop better-functioning induction systems, but also to gain a better understanding of how this important tuning element affects engine power. A particularly revealing test can be done by overlaying port velocities and cylinder pressures for various inlet taper angles.

Port Flow Velocities

Another very important element of intake and exhaust tuning is port flow velocity. The speed at which gasses move through the ports essentially is controlled by port area and piston speed. For example, if intake port velocity is too low, gas particles flowing into the cylinder near IVC will not have sufficient momentum to overcome the rise in cylinder pressure as the piston moves up the bore. Fresh charge will flow back

Wave-Dynamics Analysis

out of the cylinder into the inlet tract. Furthermore, when the ports are too large, all pressure waves generated by piston motion and exhaust gas outflow are diminished. This will decrease the effectiveness of returning pressure waves during scavenging and cylinder filling. In fact, port size is so important that we can make this blanket statement: Developing an engine with optimum port sizes will potentially produce more power than the same effort put forth in determining optimum tuned runner lengths!

Research has shown that maximum port velocity through the minimum cross-sectional area of the runner should fall between 0.5 to 0.6 Mach, or about 600- to 720-feet-per-second. Port velocities higher than 0.6 Mach produce no further increases in volumetric efficiency. Since it is impossible for any port to generate optimum flow velocities at all engine speeds, it is essential that the engine builder accurately determine the required operating range for the engine and develop ports that flow appropriately at these speed ranges. If a broad power range is required, port areas should be sized so that maximum engine speeds produce port velocities of about 0.75 Mach. This will place optimum velocities (between 0.5 and 0.6 Mach) at lower engine speeds, optimizing volumetric efficiency vs rpm. If high-speed, maximum power is the goal, then port velocity at peak engine speed should be no higher than 0.6 Mach.

During your design sessions, here's some important concepts to keep in mind. It

"In-Tune" Induction System

Figure 12

Intake Pressure Crank-Angle Graph

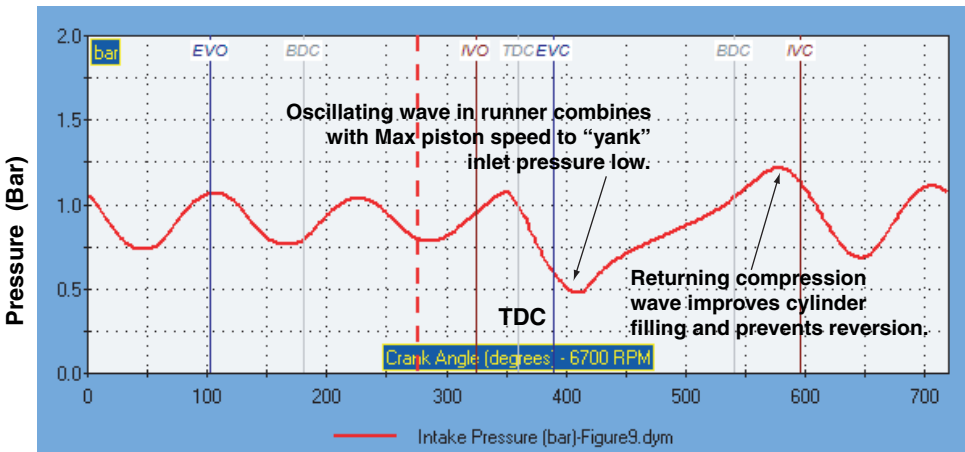

This is a good example of "in tune" induction pressures. The intake pressure wave is oscillating inside the runner and arrives at the intake valve during maximum piston speed (highest volume change) approximately 60- to 80-degrees after TDC. The "trough" of this wave combines with the suction created by the piston moving down the bore to "yank" the pressure wave to a very low amplitude. This low pressure generates a strong expansion wave that reflects back from the open-end runner as an equally strong compression wave that arrives at IVC. This not only drives additional charge into the cylinder, but reduces or eliminates reversion.

Wave-Dynamics Analysis

is often possible to make port areas small enough—and velocities high enough—to completely eliminate intake reversion at IVC. When this is accomplished, it often produces insufficient port volume and constricted flow. A better approach, producing higher peak power, is to allow some reversion to occur. It is also possible to design ports that flow between 0.5 or 0.6 Mach and do not show an increase in power. This situation can occur when intake valve or port restriction becomes too great. In these cases, the engine designer will simply have to experiment with several different port sizes, valve diameters, and valve lifts to find the optimum combination. The following formula can help you ballpark the required minimum port cross-sectional areas:

$$\text{Minimum Area (Square Inches)} = \text{RPM} \times \text{STROKE} \times \text{BORE}^2 / 190,000$$

This formula is an approximation that tends to provide conservative values. (RPM, STROKE, and BORE are in inches)

One reason this formula can only be an approximation of port area is that port velocity is also dependent on the valve-discharge coefficient. This value is the measured volume of flow across the valve divided by the perfect, theoretical (isentropic) flow. The discharge coefficient will always be less than one and is essentially a rating for the efficiency of the valve. Specific discharge coefficient values are unique for

Exhaust And Cam Timing In Sync

Figure 13

Pressure Crank-Angle Graph

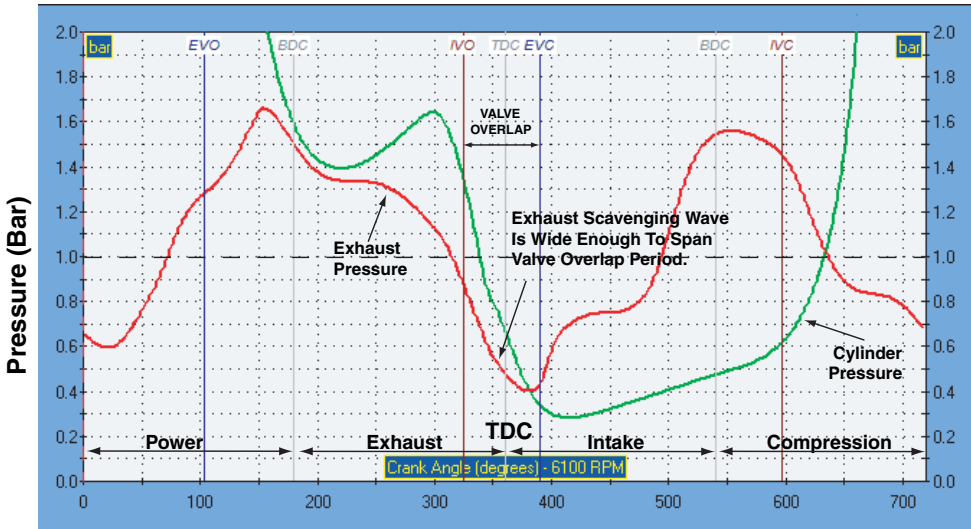

These engine pressures depict an engine with an exhaust system and cam timing that are “in-tune.” The scavenging wave is wide enough to cover the overlap period, assisting exhaust gas outflow and preventing charge reversion.

Wave-Dynamics Analysis

each valve and cylinderhead design. The simulation allows the direct input of flow-bench data and will calculate the discharge coefficients for specific cylinder head combinations. Since about 30% of flow loss through the port occurs at the valve, an improved discharge coefficient can result in substantial performance gains.

EXHAUST TUNING

Incomplete removal of exhaust gases from the cylinder reduces engine performance in two ways. First, volumetric efficiency is decreased when residual gases occupy space within the cylinder that could have been filled with fresh charge. Second, higher cylinder pressures, resulting from incomplete exhaust blowdown, force residual burnt gasses into the inlet tract upon IVO. This “spoils” the fresh charge pulled back into the cylinder during the intake stroke.

When the compression wave produced at exhaust valve opening (EVO) reaches

As rpm increases, the pressure-crank angle diagram curves “stretch” out to the right, as shown by these exhaust traces.

If the scavenging wave is wide enough and the overlap is short enough, the exhaust system will remain in tune throughout a wide rpm range. Good scavenging is still taking place at higher rpm in Figure-14a, but relatively little scavenging remains at even higher rpm in Figure-14b.

Exhaust System Scavenging Vs. Increasing RPM

Figure 14a

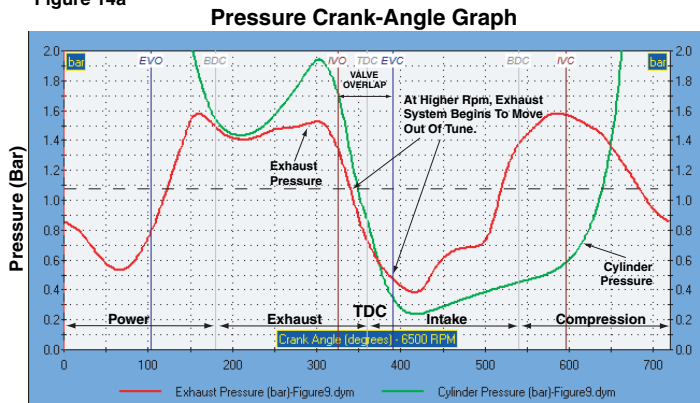
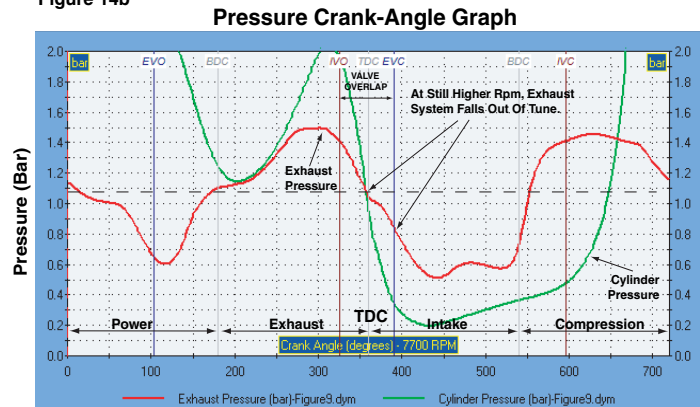

Figure 14b



Wave-Dynamics Analysis

the end of the header pipe (at the transition to the collector), a lower-strength expansion wave is reflected back to the cylinder. The positive compression wave, now of lower intensity, continues to move through the collector. When it reaches the atmosphere boundary, a second expansion wave is generated that moves back through the collector and into the primary header pipe. If the header system and cam timing are properly coordinated, the first expansion wave will return to the cylinder at, or slightly before, IVO. This will assist exhaust-gas scavenging and improve the flow of fresh charge from the induction system. Then, slightly later, the second expansion wave will arrive and continue the scavenging process until EVC. A well-designed collector can effectively broaden the scavenging wave to “cover” the entire overlap period. When this occurs, the engine and exhaust system “in tune.” If a significant portion of the overlap period is not accompanied by a scavenging wave, the engine and exhaust system fall “out of tune.”

Engine pressures illustrating an in-tune condition are pictured in **Figure-13**. As rpm increases, the pressure crank-angle diagram traces “stretch” to the right. If the scavenging wave is “wide enough” (i.e., of sufficient duration) and the overlap is short enough, the exhaust system will remain in tune even though engine rpm has increased. Notice that good scavenging is still taking place at higher rpm in **Figure-14a**, however, at an even higher rpm in **Figure-14b** the engine falls out of tune. A wide scavenging wave is particularly desirable in engines with long overlap periods. A scavenging wave that maintains a low pressure differential at the exhaust valve throughout the entire overlap period will assist exhaust scavenging, prevent reversion,

Exhaust Header Lengths Vs. Induction Flow

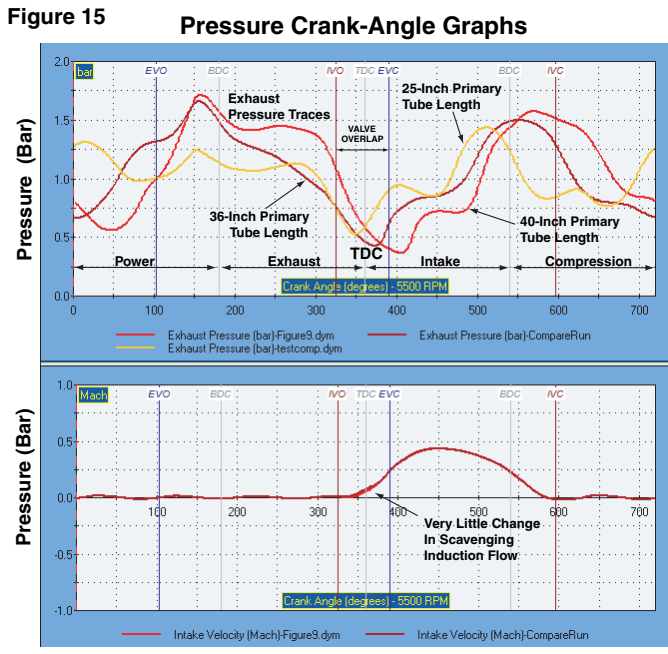

Exhaust tuning works by using the proper header pipe length to “time” the arrival of the suction wave to occur during the overlap. However, optimum primary pipe and collector lengths are not very critical for low-to medium-performance engines. This graph shows how induction flow changed as header length was varied from 25 inches to 40 inches (engine power changed by only about 2%). However, high-output, high-speed engines with long overlap periods require much more precise tubing lengths to optimize power. As power levels increase, the margin for error decreases.

Wave-Dynamics Analysis

and ensure high power levels over a wider range of engine speeds.

This fact brings to light an important point about exhaust-header tuning. *Optimum primary pipe and collector lengths are not very critical for low- to medium-performance engines* (see **Figure-15**). In these applications, overlap periods are short and cylinder pressures are often not very high at the end of the exhaust stroke (lower performance engines produce a smaller volume of exhaust gasses and blowdown more effectively in shorter time periods). However, high-output, high-speed engines with long overlap periods require much more precise tubing lengths to optimize power. As power levels increase, the margin for error decreases.

An Interesting Note About Collectors: When exhaust pulses from multiple cylinders enter a collector, primary and reflected waves interfere and interact with one another. The influence of this interaction is sometimes overstated. These “interference” waves are considerably lower in magnitude and have much

Peak exhaust velocity typically occurs twice during the exhaust cycle. The first peak-flow event, at approximately 60 degrees after EVO, is produced by maximum flow during blow-down (Figure-16a). The second event occurs at maximum piston speed on the exhaust stroke, about 73- to 82-degrees before TDC, and is the maximum flow during exhaust pumping (Figure-16b). If the flow at the second peak is the greater of the two, it usually indicates excessive restriction in the exhaust system; in this case, caused by engine overspeed (reducing the time for exhaust-gas blowdown) in a very-large displacement V8.

Peak Exhaust Flow Velocities Vs. Engine RPM

Figure 16a

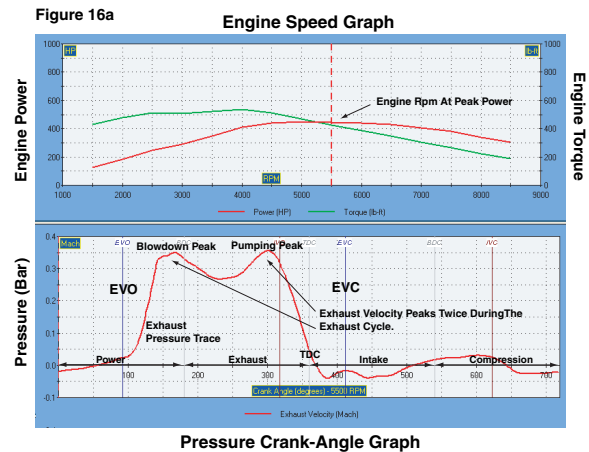
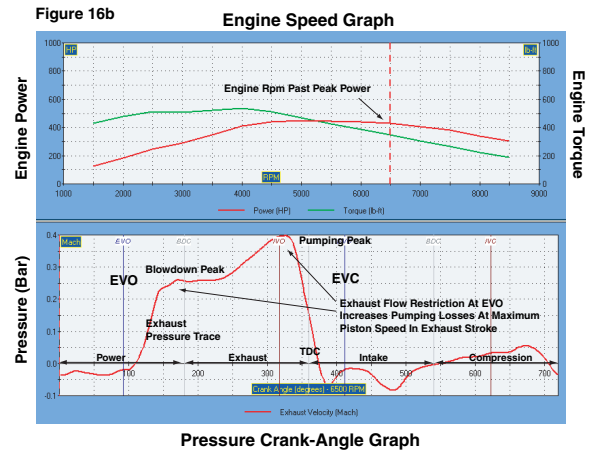

Figure 16b



Wave-Dynamics Analysis

less effect than the primary and first reflection waves from cylinder blowdown. Dr. Jon C. Morrison of the *Institute of Mechanical Engineers* conducted experiments on interference effects in collectors and concluded that multicylinder wave interference had an essentially insignificant affect on performance.

Exhaust Flow Velocities

Another important aspect of exhaust tuning is optimizing gas particle velocity throughout the exhaust system. When the exhaust valve opens (EVO), the piston is still moving downward on the power stroke. However, a large percentage of combusted gasses “blowdown” during the period between EVO and BDC. This occurs despite the fact that exhaust valve lift is relatively low. This phenomenon highlights the importance of low-lift flow characteristics of the exhaust valve and port for optimum performance. If the header system is too restrictive—possibly from insufficient pipe diameter—or if low-lift valve flow provides a restriction—often from improper port and valve seat/face contours—to allow sufficient blowdown, the piston will have to physically “pump” out the remaining gasses during the exhaust stroke. This substantially increases pumping work and cylinder pressures at IVO (which, in turn, reduce effective scavenging and create reversion into the induction system). On the other hand, when primary pipe diameters are too large, the returning scavenging wave is weakened and is too defuse to effectively assist exhaust gas outflow and initiate induction inflow during overlap. Optimum exhaust pipe diameters, like intake runner areas, are essential in producing flow velocities that achieve a balance between minimizing restriction and optimizing finite-amplitude-wave actions.

Peak exhaust velocity typically occurs *twice* during the exhaust cycle. The first peak-flow event, at approximately 60 degrees after EVO, is produced by maximum flow during blowdown. The second event occurs at maximum piston speed on the exhaust stroke, about 73- to 82-degrees before TDC, and is the maximum flow during exhaust pumping. In most well-designed engines, the first peak will be the greater of the two (see **Figure-16a**); if the flow at the second peak is greater, it can indicate excessive restriction in the exhaust system (see **Figure-16b**). When the exhaust system is designed properly, the level of the first peak should fall between 0.45 to 0.5 Mach. If flow rates over 0.5 Mach are recorded, the exhaust system is too restrictive. If flow values fall below 0.45 Mach (as is the case in the two examples shown in Figures 16a & 16b), blowdown will not generate expansion waves strong enough to effectively scavenge the cylinder during overlap. Similar to intake tuning, it is possible to establish optimum flow velocities yet not measure a performance gain. When this occurs, the problem may be excessive exhaust-valve restriction. Fortunately, this can be easily detected by reviewing the pressure-crank angle diagram or the pressure-volume diagram (discussed later in this chapter).

Exhaust Tubing Lengths

While it is impossible to exactly predict primary lengths and diameters without

Wave-Dynamics Analysis

using extremely complex formulas, it is helpful to the engine designer to have approximate starting points. The book *Performance Tuning In Theory and Practice* by A. Graham Bell, has excellent empirical formulas for header pipe length and diameters that provide reasonably accurate estimates for most applications. These formulas work well because they incorporate EVO timing within the calculation:

$$\text{HPL (Header Length Inches)} = ((850 \times (360 - \text{EVO})) / \text{RPM}) - 3$$

$$\text{HPD (Header Diameter Inches)} = ((\text{SCID} \times 16.38) / ((\text{HPL} + 3) \times 25)) \times 2.1$$

Where **EVO** is *Exhaust Valve Opening Timing* measured in the 720-degree system. **SCID** is the displacement of a single cylinder in cubic inches. **HPL** and **HPD** are lengths and diameters in inches. Solve math within nested parentheses first.

These equations only give good length and diameter estimations when the appropriate value for rpm is used. If the engine has been designed for typical street-

Exhaust Collector Length Vs. Exhaust Scavenging Wave Shape

Figure 17

Pressure Crank-Angle Graph

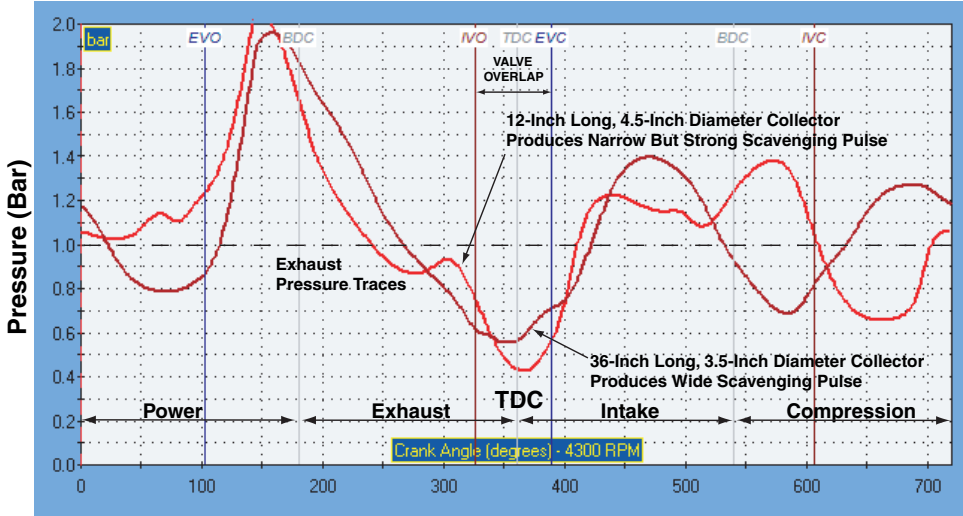

In this test, we changed the collector from 12-inch long, 4.5-inch diameter to 36-inch long, 3.75-inch diameter. Generally, increasing the collector length will broaden the scavenging wave. Smaller collector diameters place more tuning emphasis on the expansion wave generated at the open end as opposed to the header/collector boundary. The short-length, large-diameter collector (light-red line) produced the lowest and narrowest scavenging pulse. This design tends to develop more low- to mid-range power. The longer collector produces a wider scavenging wave of somewhat lower amplitude, a better overall choice for high engine speeds.

Wave-Dynamics Analysis

driving, the selected rpm should correspond with peak-torque speed. Racing engines should use either the engine speed at peak horsepower or some value in between.

While Bell's formulas derive reasonably accurate estimations of primary tubing lengths and diameters, unfortunately, there are no reliable empirical formulas for collector length and diameter. However, there are rules-of-thumb to keep in mind when choosing starting values for these dimensions. Longer collectors drive peak torque lower in the engine rpm range. This happens because, at higher engine speeds, expansion waves generated at the end of a long collector take too much time to travel back to the cylinder, failing to assist exhaust scavenging. Longer collectors should be used to widen powerbands at lower engine speeds, whereas, shorter collectors optimize peak power at higher engine speeds.

Choosing collector *diameters* requires further development of a previous theory. Recall that when a compression or expansion wave reached the open end of a pipe, a reflected wave was generated by this sudden change in area. What was not discussed, however, was that the amplitude of the reflected wave is dependent on the extent of area change. If a wave reaches an open-end pipe that discharges into the atmosphere (effectively, has an infinite change in area), then the reflected wave will be of maximum possible amplitude; nearly equal to the originating wave but of the opposite sign. If the area change is small, for instance, a 1.00-inch pipe joining a 1.05-inch pipe, a reflection wave will still be generated, but it will have a very small

Stepped Headers Can Lower Cylinder Pressures

Figure 18

Pressure Crank-Angle Graph

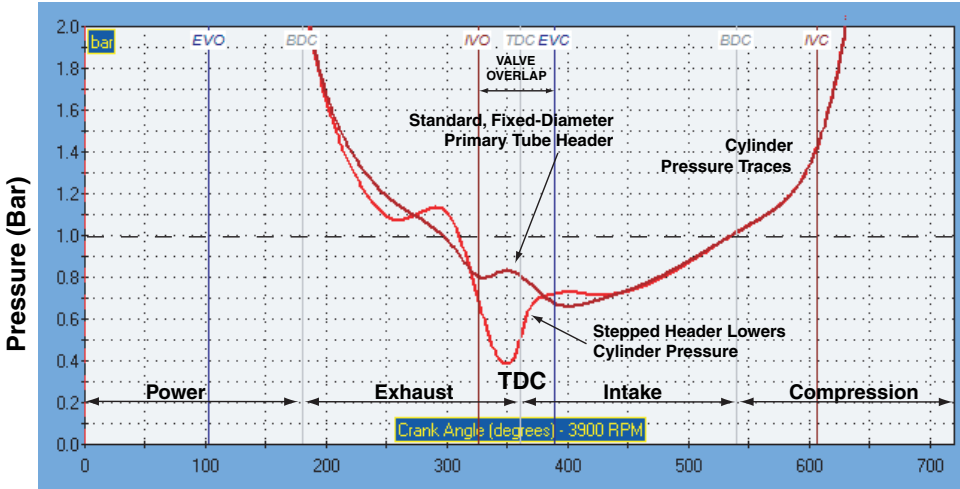

These cylinder pressure curves illustrate how stepped headers work. Stepped headers return small expansion waves at each step. These scavenging waves help exhaust gases flow out of the cylinder, particularly helpful on large-displacement, high-speed engines. Notice the lower cylinder pressures produced with stepped headers (lighter-red line). The lower pressures reduce pumping work.

Wave-Dynamics Analysis

amplitude. The lesson to be learned from this for collector design is that *smaller collector diameters decrease the area change and reduce the amplitude of the first reflected wave*. As collector diameter is decreased, higher amplitude waves are generated at the open-end of the collector and smaller reflected waves are generated at the primary/collector pipe boundary. Since the open end is farther away from the cylinder, smaller collectors often boost low- to mid-rpm power. Larger diameter collectors generate stronger waves at the primary/collector boundary, and since this is closer to the cylinder, larger collectors generally boost high-rpm power (see **Figures 17** and **18** that illustrate some of these principals).

While there are no simple formulas to accurately calculate these variables, the following formula can provide “broad ballpark” figures for high-speed, racing engines:

Collector Diameter = 1.9 x HPD
(HPL and HPD are in inches)

Collector Length = .5 x HPL

VALVE EVENTS AND TUNING STRATEGIES

The four basic valve-event timing points (IVO, IVC, EVO, EVC) can be grouped into three categories based on their influence on engine performance:

- 1) **EVC** and **IVO** are the least important individually, but the “angular” distance between these two events comprise the overlap period that has a significant effect on power.
- 2) **EVO** is the next most important timing point since it determines the beginning of the exhaust cycle which initiates cylinder blowdown.
- 3) **IVC** is the most critical event since it fixes the balance between cylinder filling and intake reversion, each having a potent effect on engine output.

Combining your knowledge of finite-amplitude waves with this information on valve timing will allow you to use the simulation to design or select camshafts (and choose related intake and exhaust components) for virtually any application.

Each valve-timing point is described below, including tips about event timing and how incorrect timing can affect wave-dynamic tuning. The reader is encouraged to use the simulation to recreate these phenomena and examine the pressure and velocity data to better understand how valve-event timing affects engine performance.

(IVO) Intake Valve Opening—This valve event marks the beginning of the intake process and valve overlap. IVO is probably the least sensitive timing point of all four valve events. However, when the exhaust system returns a broad, strong expansion wave, earlier IVO timing can boost performance. If a strong scavenging wave is not present, the same early IVO timing will cause exhaust gasses to flow into the induction system (reversion). This will substantially reduce power from not only fresh-charge “spoiling,” but also charge heating. There are several additional conditions, along with IVO, that influence intake reversion. Low engine speeds usually produce low port velocities. Since induction gasses have less momentum when they are moving at slower speeds,

Wave-Dynamics Analysis

Valve-Timing Events

Camshaft Timing Diagram

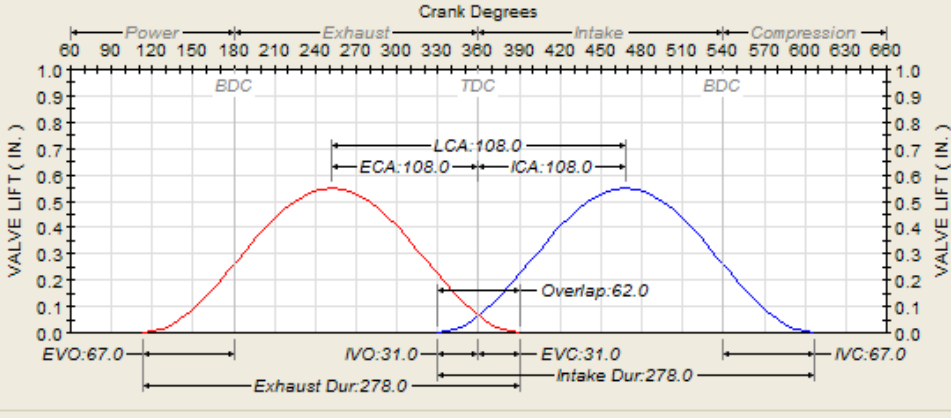

The four basic valve-event timing points (IVO, IVC, EVO, EVC) can be grouped into three categories based on their influence on engine performance: 1) EVC and IVO are the least important individually, but together comprise the overlap period that has a significant effect on power, 2) EVO is the next most important timing point since it determines the beginning of the exhaust cycle which initiates cylinder blowdown, and 3) IVC is the most critical event since it fixes the balance between cylinder filling and intake reversion, each having a potent effect on engine output.

It is easier for the piston—moving upward at IVO—to force residual exhaust gases into the inlet track. Furthermore, low intake manifold pressures that occur during part-throttle operation or with restricted carburetion create large pressure differentials between the intake port and the cylinder, again contributing to reversion. A similar condition can occur at wide-open throttle when IVO is too early, as cylinder pressures are still quite high. Engines with these conditions might benefit from later IVO timing.

(EVC) Exhaust Valve Closing—This event marks not only the end of the exhaust process, but also the ending of the overlap period. At low rpm EVC strongly influences the degree to which exhaust gases back-flow into the cylinder from the exhaust system. This low-speed back flow happens for two reasons. First, at EVC, the piston is beginning to move down the bore on the intake stroke, and since exhaust gas outflow velocity is low, the piston can begin to draw exhaust back into the cylinder. The second reason is more interesting. The negative scavenging wave created at the end of the header is always followed by another, positive compression wave. At low engine speeds both the scavenging and compression waves arrive prematurely. If the compression wave arrives during overlap, it forces exhaust gases *back into the cylinder*. One solution to this problem is the reverse-megaphone “collector” often used on motorcycle exhaust systems. This device dampens the follow-

Wave-Dynamics Analysis

up compression wave and reduces exhaust reversion at mid to low rpm. This discovery was made by accident (true for most discoveries!) when motorcycle racers tried using a reverse-megaphone in an effort to strengthen their flimsy exhaust systems.

At higher engine speeds, later EVC will shift the power curve towards higher rpm at the expense of low-speed torque. At peak power the exhaust valve should close just slightly before exhaust back-flow occurs. Don't forget that exhaust system tuning also has a significant influence on reversion. So, final EVC timing should only be determined after the exhaust system has been optimized.

(EVO) Exhaust Valve Opening—This timing point always occurs during the latter part of the power stroke and signals the start of the blowdown process. Optimum EVO timing permits a reduction in cylinder pressure that would oth-

Pressure-Crank-Angle Diagram

Figure 20

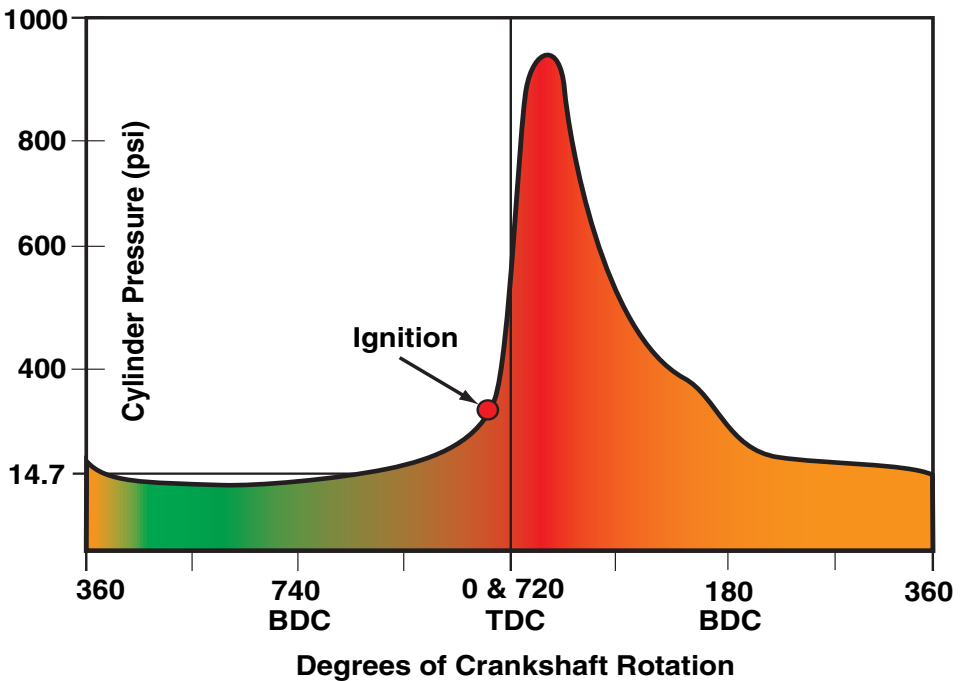

The *Pressure Crank-Angle* diagram is one of two common ways that cylinder pressures are illustrated. This method plots cylinder pressures against the crank position during the 720-degrees of the four engine cycles. On this graph (adjusted 360-degrees “forward” from the graph standard used in the simulation) it is easy to see widely varying cylinder pressures from induction through peak-ignition pressure.

Wave-Dynamics Analysis

erwise result in exhaust gas reversion into the induction system at IVO and during overlap. However, at higher engine speeds it is almost impossible for some reversion not to take place. If there is no reversion flow during overlap at high speed, it is likely (but not certain) that EVO is too early, and cylinder pressure that could have been used to push the piston during the power stroke is being prematurely expelled from the engine, reducing thermal efficiency and horsepower. If EVO occurs too late, insufficient blowdown will increase pumping work during the exhaust stroke and, in turn, reduce horsepower. Late EVO will also increase cylinder pressures at IVO contributing to reversion and additional losses in power.

Note: Thermal efficiency research has shown that within the normal range of EVO timing, this event has less affect on low-speed power than either IVC or EVC. *Therefore, EVO timing should be early enough to satisfy high-speed performance requirements, but no earlier, or thermal efficiency will suffer.*

(IVC) Intake Valve Closing—This is the most important valve event in the 4-cycle, IC engine. IVC occurs well into the compression stroke and intake flow is easily susceptible to reversion if induction velocity and/or pressure-wave tuning do not provide sufficient energy to hold back increasing cylinder pressures. This is especially true at low to mid-range engine speeds where port velocity is still sluggish. Late IVC reduces volumetric efficiency at lower rpm and potentially increases volumetric efficiency at higher rpm. Optimum IVC at maximum engine speeds depends on port velocity, pressure wave tuning, and piston speed.

Using Pressure Diagrams

The simulation can display additional graphs that illustrate otherwise “hidden” engine operating conditions. One of these important graphs illustrate cylinder pressure as a function of crank angle throughout the 4-cycle process—called a *Pressure-Crank-Angle Diagram* shown in **Figure-20** (to recreate this graph, use either the center or bottom graph on the right program pane, redefine the **X** axis to *Crank Angle*, **Y1** to *Cylinder Pressure*, and **Y2** axis to *None*). Cylinder pressure can also be graphed as a function of cylinder volume—called a *Pressure-Volume*, or *PV Diagram* as shown in **Figure-21** (using either the center or bottom graph, redefine the **X** axis to *Cylinder Volume*, **Y1** to *Cylinder Pressure*, and **Y2** axis to *None*).

The Pressure-Crank-Angle Diagram

The *pressure crank-angle* diagram plots cylinder pressure against the position of the crankshaft during all four cycles (when this graph is reproduced, the zero point is fixed at TDC just after ignition on the power stroke). Ambient or atmospheric pressure forms the baseline for the vertical “Cylinder Pressure” axis, below which vacuum levels are plotted. As the intake stroke begins, cylinder pressure decreases to near

Wave-Dynamics Analysis

Pressure-Volume Diagram

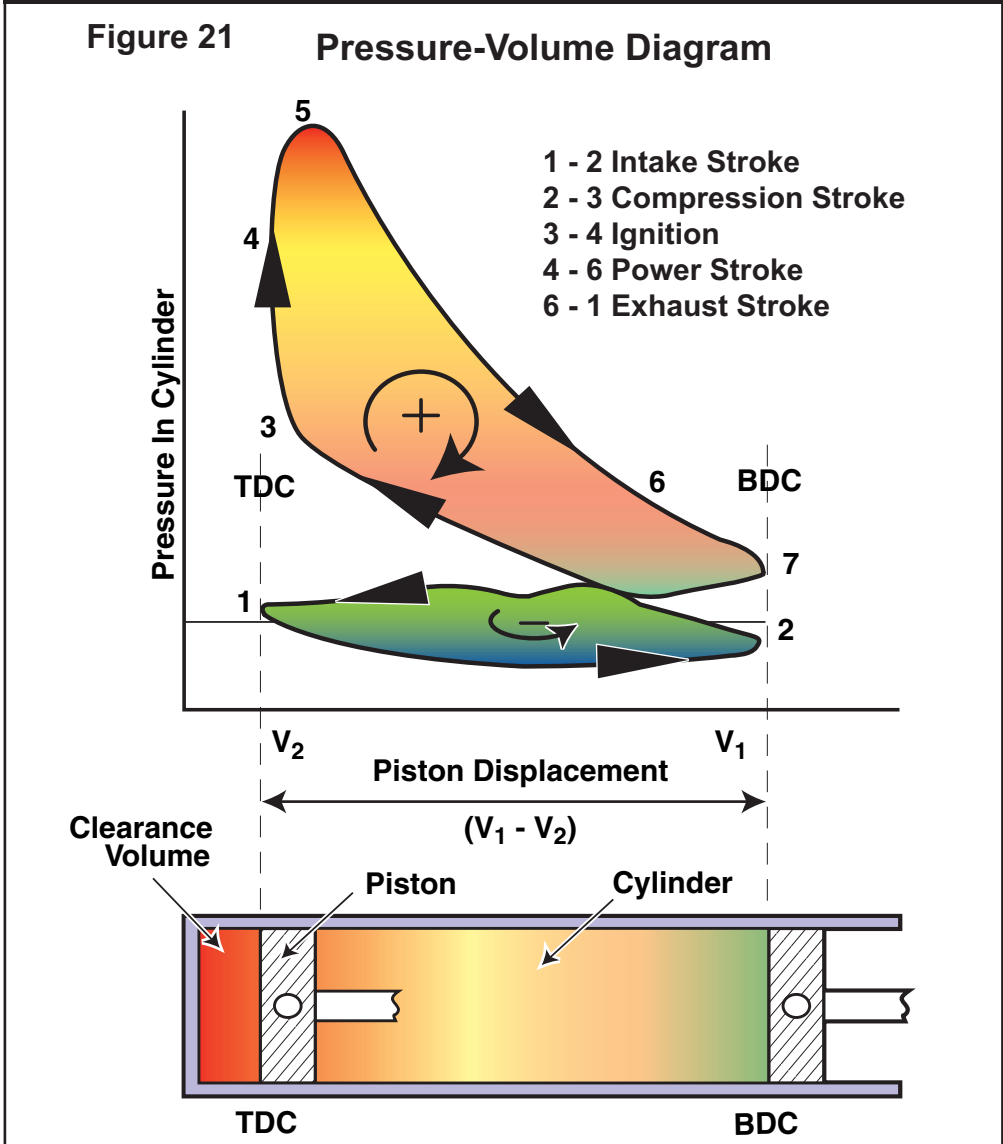

The PV diagram compares cylinder pressure to displaced volume and illustrates the same cylinder pressures displayed in the pressure crank-angle diagram. The PV diagram has the remarkable feature of isolating the *work consumed* from the *work developed* by the engine. The area within the lower loop, drawn in a counterclockwise direction, represents the work consumed by pumping losses (exhaust and intake stroke). The upper loop area, drawn in a clockwise direction, indicates the work produced by expanding gasses after combustion (compression and power stroke). The PV diagram can be a useful tool for optimizing valve-event timing, with the pumping loop providing the most helpful information.

Wave-Dynamics Analysis

ambient as exhaust venting concludes. Pressures then change to a slight vacuum during the intake stroke (or a much stronger vacuum during part-throttle operation) until the cycle ends with the closing of the intake valve. Now the trapped charge is compressed and cylinder pressures rise to a few hundred pounds per square inch (psi). Typically, a few degrees before the piston once again reaches TDC, the spark plug fires, igniting the mixture and sending cylinder pressures up to several hundred or even thousands of psi within about 40 degrees of crank rotation. If the ignition point was timed properly, peak cylinder pressure will occur about 12 to 14 degrees after TDC. This timing allows cylinder pressures to be most efficiently converted to rotational force or torque by the rod/crank assembly. As the piston continues to move down the cylinder and pressures decrease, the exhaust valve opens, beginning a dramatic drop in pressure. Finally, cylinder pressures stabilize at a few psi during the exhaust stroke when remaining burnt gasses are forced out of the cylinder.

The Pressure-Volume Diagram

The pressure crank-angle diagram provides a straightforward view of the widely varying pressures in the cylinder. While it's easy to see "what's happening and where it's happening" with this diagram, another method of plotting the identical cylinder pressures offers a very different "look" and unique insight into the same data. This plot, known as a *pressure-volume (PV, called a Pee-Vee or indicator) diagram*, is very helpful in understanding the work produced-from and consumed-by the engine.

The PV diagram plots pressure against the displaced volume in the cylinder. Notice in the illustration (**Figure-21**) that the curve tends to wrap around and reconnect with itself, forming a complete path. This curve represents cylinder pressures throughout the entire Otto-cycle process. It begins at the same point as the previous crank-angle diagram—just after the intake valve opens—marked as a **1** on the graph. The cylinder and piston below the graph illustrate the position of the piston and the volume in the cylinder at each point on the PV. As the intake stroke continues, the piston moves down the bore and the plot indicates pressure below atmospheric continuing to point **2**. Here the piston begins to move back up the bore and pressure rises as the compression cycle begins. At point **3**, the fuel is ignited, rapidly increasing cylinder pressure. The piston reaches TDC at point **4**, and the power stroke begins. Cylinder pressure continues to rise to point **5**, ideally about 15 degrees after TDC. The exhaust valve opens at point **6**, just before BDC, assisting in cylinder depressurization. The piston reaches BDC at point **7**. The exhaust cycle continues as the piston moves back up the bore maintaining some positive pressure in the cylinder until, at point **1**, the piston once again reaches TDC.

Note: The lower "pumping" loops illustrated in the accompanying PV diagrams depict naturally-aspirated engines (it's called a "pumping" loop because the engine is either pumping in fresh charge or pumping out exhaust gasses; the average pressure of this loop is the pumping mean effective pressure— P_{mep}). *This pressure loop will look completely different for a supercharged engine because positive (forced induction) pressures will act on the piston during the intake stroke.*

Wave-Dynamics Analysis

PV Diagram Of Cylinder Misfire

Figure 21a Pressure-Volume Diagram
Cylinder Misfire

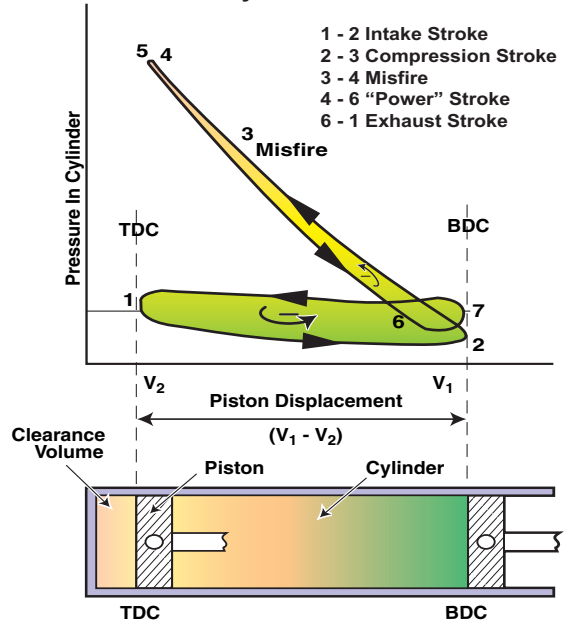

The work-isolating concepts of a PV diagram are evident with a cylinder misfire. In this case, the air/fuel mixture is drawn into the cylinder as usual, but it fails to ignite and boost cylinder pressure. The PV diagram of this event still consists of two loops; however, if we start at point 1 and trace through the sequence of pressures, we outline two counter-clockwise loops. Both loops represent power consumed by the engine.

Notice that the "pressure areas" have internal directional arrows that indicate the same sequence of events just described. Trace along the curve, again, from the starting point 1 around part of the "lower loop" marked with a minus sign. Notice that you are moving in a counterclockwise direction. As you move from point 2 through the junction between the upper and lower loops, continuing past points 3, 4, 5, 6 and finally arrive at point 7, this trip has taken you around the "upper loop," marked with a plus sign, in a clockwise direction. Finally, as you move past point 7 back to 1, you trace out the upper half of the "lower loop," again in a counterclockwise direction. What does all the "clockwise stuff" have to do with anything? You may be amazed by the relationship. A PV diagram has the remarkable feature of isolating the *work consumed* from the *work developed* by the engine. The area within the lower loop, drawn in a counterclockwise direction, represents the work consumed by the engine "pumping" the charge into the cylinder and forcing the exhaust gasses from the cylinder. The upper loop area, drawn in a clockwise direction, indicates the work produced by the engine from pressures generated by expanding gasses after combustion.

Look again at the crank-angle diagram, **Figure-20**. Would you have thought the relatively "simple" curve in that illustration would contain so much more "hidden" information?

Let's test the work-isolating concepts of PV diagram with a cylinder misfire (see

Wave-Dynamics Analysis

Pumping Loop Vs. RPM

Figure 22

Pressure-Volume Diagram

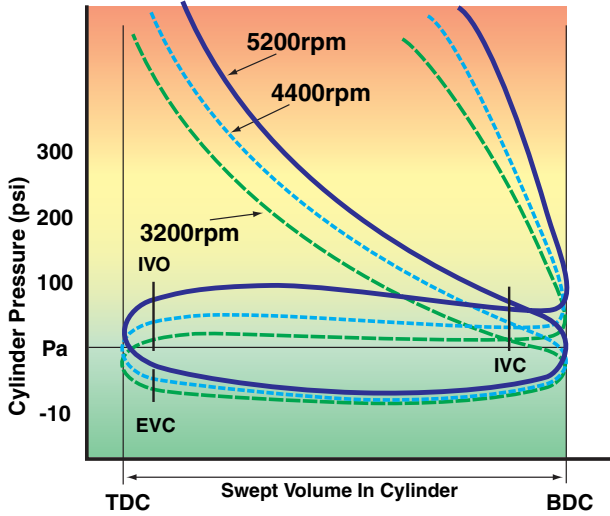

This PV diagram illustrates how the pumping loop speed increases as engine speed increases from 3200rpm to 5200rpm. Notice how the lower portion of the loop (the intake cycle) remains relatively constant, while the upper portion of the loop (the exhaust cycle) dramatically rises as rpm increases. The changes in exhaust pressure are caused by the decreasing time available to blowdown the cylinder as engine speed increases. Higher pumping pressures increase pumping work (increasing Pmep) and that consumes horsepower.

Figure-21a). In this case, the air/fuel mixture is drawn into the cylinder as usual, but it fails to ignite and boost cylinder pressure. The PV diagram of this event still consists of two loops (more or less). However, if we start at point 1 and trace through the sequence of pressures, we outline two counterclockwise loops. So both loops represent power consumed by the engine. The upper loop encloses very little area since most of the power used to compress the charge is returned when the piston is forced back down the bore by the compression pressure on the “power” stroke.

Note: The pressure in the cylinder as the piston moves down the bore on the “power” stroke of a misfire is slightly less than the measured pressure on the compression stroke because the charge has given up some heat, and therefore pressure, to the cylinderwall and other surfaces.

Optimizing Valve Events

The pressure-volume diagram can be a useful tool for locating optimum valve event timing, with the pumping loop providing the most insightful information. **Figure-22** shows a close-up view of a typical pumping loop. This period is also called the “valve-open cycle,” since at least one of the valves is open throughout the entire loop. This illustration also shows how the pumping loop changes shape as engine speed increases from 3200rpm to 5200rpm. The lower, pumping loop obviously “balloons.” However, notice that the lower portion of the lower loop (the intake cycle) remains relatively constant, while the upper portion of the loop (the exhaust cycle) dramatically rises as rpm increases. The increasing exhaust pressures are the result of the

Wave-Dynamics Analysis

Early Exhaust And Intake Valve Closing

Here are the effects of early and late exhaust valve openings. Early EVO (dotted line) causes the pressure curve to slope strongly from left to right as cylinder pressure decreases during blowdown. If EVO is too late the pressure curve takes much more of a vertical "dive" and tends to level out considerably above Pa.

Figure 23

Pressure-Volume Diagram

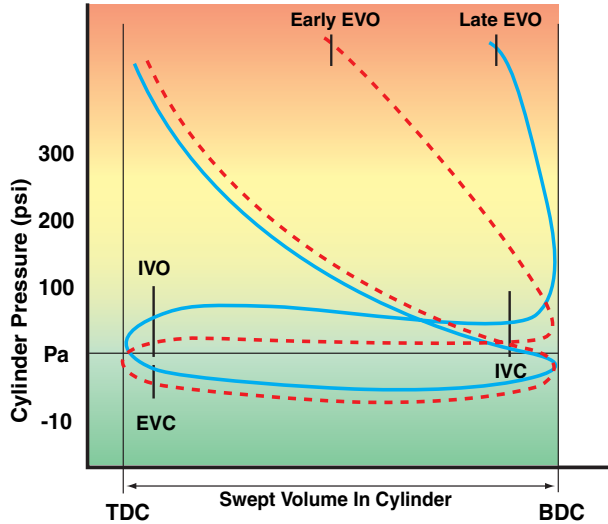

Effects Of Early And Late Valve Timing Events

Figure 24

Pressure-Volume Diagram

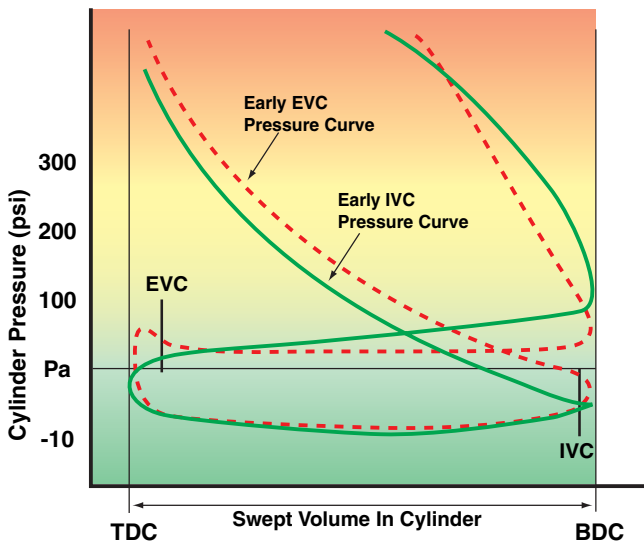

This PV plot shows the sharp rise in cylinder pressure from too early EVC timing (dotted line). The "spike" at the left end of the loop is caused by the upward moving piston beginning to re-compress exhaust gasses. Also illustrated is too early IVC timing (solid line). Notice the "pointed tail" at the lower right. This is produced when the intake valve closes near BDC and prevents the inflow of fresh charge normally caused by the ram tuning effects of the induction system.

Wave-Dynamics Analysis

decrease in time available to blowdown the cylinder as engine speed increases. Higher pumping pressures increase pumping work (increasing P_{mep}) and that consumes horsepower.

The 5200rpm curve in **Figure-22** also shows the beginning of “bulge” forming around maximum piston speed on the exhaust stroke. This is a sign of exhaust flow restriction, sometimes caused by insufficient exhaust valve size and/or valve lift. This “restriction” bulge also would be visible on the pressure-crank angle diagram where cylinder pressure drops to parallel inlet pressure, at about 80 degrees before TDC.

Figure-23 show how early and late exhaust valve openings affect cylinder pressure. Notice the slope of the blowdown pressure at the upper right hand corner of the diagrams. If EVO is too early (dotted line), the pressure curve slopes strongly from left to right as cylinder pressure decreases during blowdown. If EVO is late, the pressure curve takes a much more vertical “dive” and tends to level out considerably higher above **Pa**. Ideal EVO timing will produce a pressure plot that will slope from left to right at a relatively steep angle (similar to the 4400rpm curve in **Figure 22**).

Figure-24 shows the sharp rise in cylinder pressure from very early EVC timing (dotted line). The “spike” at the left end of the loop is caused by the upward moving piston beginning to re-compress exhaust gasses trapped in the cylinder when the exhaust valve closed too early. This figure also illustrates how early IVC timing can change the lower part of the pumping loop (solid line). Notice the “pointed tail” at the lower right. This is produced when the intake valve closes near BDC and prevents the inflow of fresh charge normally developed by the ram tuning effects of the induction system.

One Final Note: IVO is the least sensitive valve event, and its opening point (within the range of typical valve event timing) is often not distinguishable on the PV diagram.

Wave-Action Filling & Emptying Simulations Version 6

FAQ's

FREQUENTLY ASKED QUESTIONS

The following information may be helpful in answering questions and solving problems that you encounter when installing or using this simulation. If you don't find an answer to your problem here, send an email to: support@motionsoftware.com. You can also fax in the **Mail/Fax Tech Support Form** (*Motion Software provides Email and Fax technical service to registered users only*). We will review your problem and return an answer to you as soon as possible.

IMPORTANT: The simulation includes Motion's Software Update tool that automatically checks for updates (plus, you can initiate a update check at any time by selecting *Check For New Version* from the **HELP** menu in the program). You'll not only receive the usual bug fixes and minor enhancements, but often updates include entirely new features and modeling capabilities.

Many of these new features have been requested by our users (yes, we really do listen to our customers!). If you have ideas for enhancements or you have found issues with our software, please let us know. You'll probably see your requested feature "appear" in the next update!

GENERAL TROUBLESHOOTING

Here are just a few of the things you might think about when trying to solve problems:

- a) If the cam data that you are testing or reviewing in one of the graphs appears incorrect, make sure you are viewing the correct lobe (this is particularly important if you are using a *Variable-Valve-Timing* cam setup).
- b) If a turbocharging system is not developing the boost or power you expect, remember that the *Boost Limit* is an upper limit. It does not force a too-large turbo to spin up more quickly and generate the desired boost. You need to select the correct size turbo, turbine, and A/R ratio to obtain the desired boost curve.
- c) Take a few minutes to carefully review all your component selections. You may find that reviewing your engine component selections directs you to the source of the problem. It's easy to look at a component specifications a hundred times and see the "right" number, only to look again and find that an error that was in "plain sight."

Troubleshooting & Common Questions

- d) If you are certain that you have found an outright “bug,” we are anxious to hear from you. It is our firm intention to make sure this engine simulation stays one of the most sophisticated, stable, and useful development tools available to the engine builder and enthusiast. Use the email address *support@motionsoftware.com* or *latherton@motionsoftware.com* to contact our development team. Always include your main email address and attach any .dxml engine files (or any other related cam or flow files) that may help us diagnose the problem. Include a thorough explanation of the issues. We will make every attempt to review and reply to your problem as soon as possible.

INSTALLATION/BASIC-OPERATION QUESTIONS

Question: Received an “Error Reading Drive D” (or another drive) message when attempting to install the software. What does this mean?

Answer: This means your computer cannot read the disk in your CD-ROM drive. The disk may not be properly seated in your drive, the drive may be defective, or the disk may be damaged. If you can properly read other CDs in your CD-ROM drive, but our software distribution disk produces error messages, try requesting a directory of a known-good disk. If these operations produce an error message only when using the Motion CD, the disk is probably defective. Contact Motion Software, Inc., for a replacement (email address on the back cover of this manual). Replacement CD's or USB Security Keys are free for as long as you own our software (you must be the original purchaser). Just return the defective merchandise to Motion Software, Inc., and we will replace it at no charge. If you have lost the CD or the USB Key, please call for replacement pricing.

Question: “Could not locate HASP USB Security Key” error message was displayed when trying to run Dynomation6.

Answer: If Dynomation6 displays an error message indicating that the HASP Security Key is missing or cannot be found, here are some quick steps you can follow to isolate and correct common problems:

- a) Make sure the Security Key is, in fact, properly connected to a functioning USB port on your computer or to a USB hub that is connected to your computer. If you connected the Key to a hub, try connecting it directly to a USB port on your computer system. The Security Key contains a small LED that lights up when it is properly connected and after it has located the correct software drivers on your system (these drivers are normally installed during Dynomation6 installation, see step “c” below).
- b) Make sure your USB port is functioning correctly by disconnecting all other USB devices from your system. Then connect the Security Key to another USB port. If that works, try another USB device in the port that did not work to determine if that port is defective.
- c) Try re-installing or updating the Security Key drivers. Updates are posted on the Support page of the Motion Software, Inc., website (www.motionsoftware.com).

Troubleshooting & Common Questions

com). Restart your computer after you install the new drivers.

And here's some additional tips for both **Dynomation6** and **DynoSim6** users:

- d) Is your computer experiencing technical difficulties, such as non-functional devices, spontaneous rebooting, etc? If so, the device drivers for our Security Key may not properly install on your system. You should have a “stable” computer system and a “clean,” virus-free Windows installation to properly use this software. You also should have the latest Windows updates installed on your system (available free from www.microsoft.com).
- e) Try installing this software (and for Dynomation6, the Security Key) on another computer system to determine if your computer is at fault.
- f) Make sure you are using the latest version of this simulation by opening the Windows **Start** menu, then choose **Motion-Dynomation6 Engine Sim (or Motion-DynoSim6 Sim)**, and finally click on the **MotionUpdater** icon in that folder. Your computer must be connected to the Internet to obtain the latest updates.
- g) Refer to additional information on the Support page of the **www.MotionSoftware.com** website.

Question: The software won't start. It displays messages saying something like, “msvcrt.dll linked to missing export...”

Answer: You need to update your version of Windows by using the Windows Update service built into Windows, or directly go to www.microsoft.com to obtain Windows updates. Consider updating to Windows7 or Windows10.

Question: The simulation produced an *Assertion Failure* error. What should I do?

Answer: Please note down all of the information presented in the error-message box, provide a quick synopsis of what led up to the error, then send this information, along with the **Dynomation7-Run.log** or **DynoSim6_Run.log** data file (located in the C:/Dynomation6 or C:/DynoSim6 director) to Motion Software at support@motionsoftware.com. Thank you for your assistance in helping us improve this software. If you cannot send this email, contact support@motionsoftware.com for assistance.

SCREEN DISPLAY QUESTIONS

Question: Even though I have a 21-inch monitor, I can only see a portion of the simulation screen on my monitor. What can I do so that I don't have to scroll both horizontally and vertically?

Answer: The *screen resolution* of your monitor (not its size) determines how much of the simulation screen you can see without scrolling left and right. You can change *screen resolution* by **RIGHT CLICKING** on your desktop, then selecting **PROPERTIES** from the drop-down menu. Choose the **SETTINGS** tab and

Troubleshooting & Common Questions

increase screen resolution by moving the **Screen Area** slider to the right. For more information about screen resolution, refer to the documentation that was supplied with your computer, your video graphics card, or with Windows.

BORE/STROKE/SHORTBLOCK QUESTIONS

Question: I cannot find the shortblock I want to model in the Shortblock menus?

Answer: The Shortblock menu is simply a list of most of the common engines. If you cannot find your shortblock in the menus, simply enter the bore, stroke and number of cylinders directly in the Shortblock Component Category. Send us an email and let us know what engines you would like to see in the menu (latherton@motionsoftware.com).

INDUCTION/MANIFOLD/FUELS QUESTIONS

Question: When I choose induction flow that is too large for an engine (for example 4000cfm on a Honda 4-cylinder), why does the power increase without showing “bog,” or power drop at low speeds?

Answer: The simulation assumes an optimum air/fuel ratio regardless of the selected CFM rating. As a result, the program produces increasingly smaller positive results from larger-and-larger induction flows. However, you won't go wrong if you use common sense when selecting induction/carburetor flow capacities.

Question: The engine I am building uses two carburetors. How can I simulate the airflow?

Answer: You can simulate induction airflow from less than 100 to 7000cfm, rated at either the standard pressure drop of 1.5-inches or 3.0-inches of mercury (a pressure drop of 1 inch of mercury is equivalent to 13.55 inches of water). To simulate two carburetors, simply add the airflow and enter the total cfm value into the Induction category (or you can use the *Flow Calculator* if you are unsure about the rated flow of a venturi or throttle).

CAMSHAFT/VALVETRAIN QUESTIONS

Question: I built a relatively stock engine but installed a drag-race camshaft. The engine only produced 9hp @ 2000 rpm. Is this correct?

Answer: Yes. Very low power outputs at low engine speeds occur when racing camshafts are used without complementary components, such as high-flow cylinder heads, high compression ratios, and exhaust system components that match the performance potential of the cam.

Question: The simulation doesn't predict power unless I enter both seat-to-seat and 0.050-inch valve timing. Why is this necessary?

Answer: The simulation can use either Cam Profile data or 10-Point Timing (specs

Troubleshooting & Common Questions

found on your cam card and in cam manufacturer's catalog/website). To optimize accuracy with 10-Point timing, it is essential to provide both seat-to-seat and 0.050-inch timing points. With both sets of timing points, the simulation can calculate the lifter acceleration rates accurately generate a full valve-motion curve. If you only enter 0.050-inch timing points, the simulation can extrapolate seat-to-seat timing, however, this introduces potential errors in power prediction.

Question: How does the simulation allow for the different acceleration rate cams used with hydraulic, solid, and roller lifters?

Answer: The simulation calculates a valve acceleration rate and a valve-motion curve using both the seat-to-seat and 0.050-inch cam timing specifications (see previous answer). Note that the acceleration rate of cams is not directly linked to the type of lifters (e.g., mild street cams often used roller lifters), and determining the acceleration rates (intake and exhaust) from seat-to-seat and 0.050-inch timing points produces quite accurate results.

Question: Can I change rockerarm ratios?

Answer: Yes. You can directly change the rocker ratios in the Camshaft Component category. You can also use the Rocker Math calculator to get insight into how rocker-ratio changes affect valve timing and lift.

Question: I found the published factory seat-to-seat valve timing for an engine that I am building. The IVC occurs at 112 degrees (ABDC). Something goes wrong when I enter the valve events into the simulation.

Answer: There are so many ways that cam specs can be described for cataloging purposes that it can be quite confusing. The cam specs for your engine are a classic example of this lack of standards. The OEM cam listed in the factory manual is a hydraulic grind with seat-to-seat timing measured at *0.001-inch lifter rise*. Because the cam is designed for long life and quiet operation, it has extended (quiet) opening ramps. This is the reason for the large number of crank degrees between the specified "opening" and "closing" points. In fact, during the first 35 degrees of crank rotation, the lifter rises less than 0.010-inch. If this wasn't the case, and the valve truly *opened* and *closed* at the factory specified timing points, the cam would have over 350-degree duration, and it's unlikely the engine would even start! Simulation seat-to-seat timing should be based on the SAE standard of 0.006-inch valve rise. The 0.001-inch lifter-rise figures published in your factory manual do not indicate when mass flow begins in the ports and are useless for engine simulation purposes.

Question: My cam manufacturer's catalog does not list seat-to-seat, valve-event timing. But it does list seat-to-seat intake and exhaust duration, lobe-center angle, and intake centerline. Can I calculate the valve-event timing from these figures?

Answer: Yes. Use the *CamMath QuickCalculator*™ built into the simulation to calculate the intake and exhaust opening and closing points. You'll need the fol-

Troubleshooting & Common Questions

lowing information:

- 1) **Intake Duration**
- 2) **Exhaust Duration**
- 3) **Lobe-Center Angle** (sometimes called lobe separation angle).
- 4) And the **Intake Centerline Angle**.

Question: I have been attempting to test camshafts from data obtained on the Internet. I can find the duration and lobe center angle. However, I can't find the seat-to-seat timing (they act like it's a trade secret!). Can I use the available data to run a simulation?

Answer: No. Our suggestion is to contact another cam manufacturer.

COMPRESSION-RATIO QUESTIONS

Question: The simulation calculated the total Combustion Volume at 92ccs. But I know my cylinder heads have only 75ccs. What's wrong?

Answer: This confusion comes from assuming that the calculated **Total Combustion Volume** is the same as your measured combustion-chamber volume. The *Total Combustion Volume* is the entire volume that remains in the cylinder when the piston reaches top dead center.

Question: When using the Compression Ratio Calculator, the "Measured Volumes, Burette Method" mode, Item-2 should, but does not, allow a zero entry. I have flattop pistons with zero deck clearance and 5cc valve pockets. Wouldn't this be the correct entry since I am running zero deck clearance?

Answer: The assumption in the "Measured Volumes" option is that there is a volume (the combination of the displacements in the domes/dishes/pockets) that cannot be calculated by the engine builder. The only practical way to measure this volume is to move the piston down the bore an arbitrary amount, say 0.250 (sufficient to ensure that the entire dome is below the deck surface), and measure the volume in the cylinder (with a liquid and a burette). This is then compared to the volume of a cylinder 0.250 inches high with the same bore diameter. The difference in volume is the volume taken up by the dome/dish/pockets. However, on your engine, you know that the flattop pistons with valve pockets that you have will produce a zero deck height at TDC, and the displacement of the valve pockets is 5cc. Knowing this, you can select the "Known Volumes" model, set the deck clearance to zero, add 5cc for valve-pocket volume, enter the combustion chamber volume, and the compression ratio will be calculated.

GENERAL QUESTIONS ABOUT RUNNING A SIMULATION

Question: The simulation displayed an error message "Program was unable to complete the simulation. A more balanced combination of components..." What

Troubleshooting & Common Questions

went wrong?

Answer: The combination of components you have selected produced a calculation error in the simulation process. This can be caused by using restrictive induction flow on large-displacement engines, using radical cam timing on otherwise mild engines, or large taper angles on intake and exhaust passages. Try increasing induction flow, selecting a cam with less duration, reducing the compression ratio, or try changing the *Wave-Action Simulation Mode* from **Course** to **Fine** or **SuperFine** (this decreases the Mesh size used to divide engine passages for analysis and provides a more effective damping of shock waves).

Question: When I run a simulation, part of the horsepower and torque graph goes off the end of the graph. What can I do to correct the display?

Answer: Open the **Graph Options** menu (right-click on the graph) and select **Auto Range** for the **Y1** or **Y2** variable.

Troubleshooting & Common Questions



MINI GLOSSARY

0.050-Inch Cam Timing Method—See **Cam Timing**, @ 0.050-inch.

ABDC or After Bottom Dead Center—Any position of the piston in the cylinder bore after its lowest point in the stroke (BDC). ABDC is measured in degrees of crankshaft rotation after BDC. For example, the point at which the intake valve closes (IVC) may be indicated as 60-degrees ABDC. In other words, the intake valve would close 60 degrees after the beginning of the compression stroke (the compression stroke begins at BDC).

Air-Fuel Ratio—The proportion of air to fuel: by weight: that is produced by the carburetor or injector.

ATDC or After Top Dead Center—Any position of the piston in the cylinder bore after its highest point in the stroke (TDC). ATDC is measured in degrees of crankshaft rotation after TDC. For example, the point at which the exhaust valve closes (EVC) may be indicated as 30-degrees ATDC. In other words, the exhaust valve would close 30 degrees after the beginning of the intake stroke (the intake stroke begins at TDC).

Atmospheric Pressure—The pressure created by the weight of the gases in the atmosphere. Measured at sea level this pressure is about 14.69psi.

Back Pressure: A pressure developed when a moving liquid or gaseous mass passes through a restriction. “Backpressure” often refers to the pressure generated within the exhaust system from internal restrictions from tubing and tubing bends, mufflers, catalytic converters, tailpipes, or even turbochargers.

BBDC or Before Bottom Dead Center—Any position of the piston in the cylinder bore before its lowest point in the stroke (BDC). BBDC is measured in degrees of crankshaft rotation before BDC. For example, the point at which the exhaust valve opens (EVO) may be indicated as 60-degrees BBDC. In other words, the exhaust valve would open 60 degrees before the exhaust stroke begins (the exhaust stroke begins at BDC).

Big-Block—A generic term that usually refers to a V8 engine with a displacement that is large enough to require a physically “bigger” engine block. Typical bigblock

Mini Glossary

engines displace over 400 cubic inches.

Blowdown or Cylinder Blowdown—Blowdown occurs during the period between exhaust valve opening and BDC. It is the period (measured in crank degrees) during which residual exhaust gases are expelled from the engine before the exhaust stroke begins. Residual gasses not discharged during blowdown must be physically “pumped” out of the cylinder during the exhaust stroke, lowering power output from consumed “pumping work.”

Bore or Cylinder Bore—The internal surface of a cylindrical volume used to retain and seal a moving piston and ring assembly. “Bore” is commonly used to refer to the cylinder bore diameter, unusually measured in inches or millimeters. Bore surfaces are machined or ground precisely to afford an optimum ring seal and minimum friction with the moving piston and rings.

Brake Horsepower (bhp)—Brake horsepower (sometimes referred to as shaft horsepower) is always measured at the flywheel or crankshaft by a “brake” or absorbing unit. Gross brake horsepower describes the power output of an engine in stripped-down, “race-ready” trim. Net brake horsepower measures the power at the flywheel when the engine is tested with all standard accessories attached and functioning. Also see Horsepower, Indicated Horsepower, Friction Horsepower, and Torque.

Brake Mean Effective Pressure (bmep)—A theoretical average pressure that would have to be present in each cylinder during the power stroke to reproduce the force on the crankshaft measured by the absorber (brake) on a dynamometer. The bmep present during the power stroke would produce the same power generated by the varying pressures in the cylinder throughout the entire four-cycle process.

BTDC or Before Top Dead Center—Any position of the piston in the cylinder bore before its highest point in the stroke (TDC). BTDC is measured in degrees of crankshaft rotation before TDC. For example, the point at which the intake valve opens (IVO) may be indicated as 30-degrees BTDC. In other words, the intake valve would open 30 degrees before the intake stroke begins (the intake stroke begins at TDC).

Cam Timing @ 0.050-Lift—This method of determining camshaft valve timing is based on 0.050 inches of tappet rise to pinpoint timing events. The 0.050-inch method was developed to help engine builders accurately install camshafts. Lifter rise is quite rapid at 0.050-inch lift, allowing the cam to be precisely indexed to the crankshaft. Camshaft timing events are always measured in crankshaft degrees, relative to TDC or BDC.

Cam Timing @ Seat-To-Seat—This method of determining camshaft timing uses a specific valve lift (determined by the cam manufacturer) to define the beginning or ending of valve events. There is no universally accepted valve lift used to define seat-to-seat cam timing, however, the Society of Automotive Engineers (SAE) has

Mini Glossary

accepted 0.006-inch valve lift as its standard definition. Camshaft timing events are always measured in crankshaft degrees, relative to TDC or BDC.

Camshaft Advance/Retard—This refers to the amount of advance or retard from the manufacturers recommended timing that the cam is installed in the engine. Focusing on intake timing, advancing the cam closes the intake valve earlier. This setting typically increases low-end performance. Retarded cam timing closes the intake valve later which tends to help top end performance.

Camshaft Lift—The maximum height of the cam lobe above the base-circle diameter. A higher lobe opens the valves further, often improving engine performance. Lobe lift must be multiplied by the rocker ratio (for engines using rocker arms) to obtain total valve lift. Lifting the valve more than 1/3 the head diameter generally yields little additional performance. Faster valve opening rates add stress and increase valvetrain wear but can improve performance. High lift rates usually require specially designed, high-strength components.

Centerline—An imaginary line running through the center of a part along its axis, e.g., the centerline of a crankshaft running from front-to-back directly through the center of the main-bearing journals.

Duration or Valve Duration—The number of crankshaft degrees (or much more rarely, camshaft degrees) of rotation through which the valve lifter or cam follower is raised above a specified height; either seat-to-seat valve duration measured at 0.006-, 0.010-inch or other valve lifts (even 0.020-inch lifter rise), or duration measured at 0.050-inch lifter rise, called 0.050-inch duration. Intake duration is a measure of all intake lobes, and exhaust duration indicates the exhaust timing for all exhaust lobes. Longer cam durations hold the valves open longer, often allowing increased cylinder filling or scavenging at higher engine speeds.

Exhaust Center-Angle/Centerline or ECA—The distance in crank degrees from the point of maximum exhaust valve lift (on symmetric cam profiles) to TDC during the valve overlap period.

Exhaust Valve Closing or EVC—The point at which the exhaust valve returns to its seat, or closes. This valve timing point usually occurs early in the intake stroke. Although EVC does not have substantial effects on engine performance, it contributes to valve overlap (the termination point of overlap) that can have a significant effect on engine output.

Exhaust Valve Opening or EVO—The point at which the exhaust valve lifts off of its seat, or opens. This valve timing point usually occurs late in the power stroke. EVO usually precedes BDC on the power stroke to assist exhaust-gas *blowdown*. The EVO timing point can be considered the second most important cam timing event

Mini Glossary

from a performance standpoint.

Filling & Emptying Simulation—This engine simulation technique includes multiple models (e.g., thermodynamic, kinetic, etc.), and by dividing the intake and exhaust passages into a finite series of sections it describes mass flow into and out of each section at each degree of crank rotation. The Filling And Emptying method can accurately predict average pressures within sections of the intake and exhaust system and dynamically determine VE and engine power. However, the basic Filling And Emptying model can not account for variations in pressure *within* individual sections due to gas dynamic effects.

Four-Cycle Engine—Originally devised by Nikolaus Otto in 1876, the four-cycle engine consists of a piston moving in a closed cylinder with two valves (one for inlet and one for outlet) timed to produce four separate strokes, or functional cycles: Intake, Compression, Power, and Exhaust. Sometimes called the "suck, squeeze, bang, and blow" process, this technique—combined with a properly atomized air/fuel mixture and a precisely timed spark ignition—produced an engine with high efficiency and power potential. Dynomation6 and DynoSim6 are designed to simulate the functional processes of a four-cycle engine.

Horsepower—Torque measures how much work (an engine) *can* do; and power is the rate-based measurement of *how fast* the work is being done. Starting with the static force applied at the end of a torque arm (torque), then multiplying this force by the swept distance through which the same force would rotate the torque arm one full revolution determines the power per revolution: Power Per Revolution = Force or Weight x Swept Distance. James Watt (1736-1819) established the current value for one horsepower: 33,000 pound-feet per minute or 550 pound-feet per second. So horsepower is currently calculated as: Horsepower = Power Per Revolution/33,000, which is the same as Horsepower = (Torque x 2 x Pi x RPM)/33,000, or simply: Horsepower = (Torque x RPM)/5,252. The horsepower being calculated by these equations is just one of several ways to rate engine power output. Various additional methods for calculating or measuring engine horsepower are commonly used (to derive friction horsepower, indicated horsepower, etc.), and each technique provides additional information about the engine under consideration.

Induction Airflow—The airflow rating (a measurement of restriction) of a carburetor or fuel injection system. Standard automotive four-barrel carburetors are rated by the measured airflow when the device is subjected to a pressure drop equal to 1.5-inches of mercury. Two-barrel carburetors are tested at 3.0-inches of mercury.

Intake Centerline Angle—The distance in crank degrees from the point of maximum intake valve lift (on symmetric cam profiles) to TDC during the valve overlap period.

Intake Stroke—One of the four 180-degree full "sweeps" of the piston moving in the

Mini Glossary

cylinder of a four-stroke, internal-combustion engine (originally devised by Nikolaus Otto in 1876). During the intake stroke, the piston moves from *TDC* to *BDC* and inducts (draws in by lowering the pressure in the cylinder) air/fuel mixture through the induction system. Note: The 180-degree duration of the intake stroke is commonly shorter than the period during which the intake valve is open, sometimes referred to as the true “Intake Cycle.” The intake stroke is followed by the compression stroke.

Intake Valve Closing or IVC—Considered the most important cam timing event from a performance standpoint. The point at which the intake valve returns to its seat, or closes. This valve timing point usually occurs early in the compression stroke. Early IVC helps low-end power by retaining air/fuel mixture in the cylinder and reducing charge reversion at lower engine speeds. Late IVC increases high-speed performance (at the expense of low speed power) by allow additional charge to fill the cylinder from the ram-tuning effects of the induction system at higher engine speeds.

Intake Valve Opening or IVO—The point at which the intake valve lifts off of its seat, or opens. This valve timing point usually occurs late in the exhaust stroke. Although IVO does not have a substantial effect on engine performance, it contributes to valve overlap (the beginning point of overlap) that can have a significant effect on engine output.

Lobe-Center Angle or LCA—The angle in cam degrees from maximum intake lift to maximum exhaust lift. Typical LCAs range from 100 to 116 camshaft degrees (or 200 to 232 crank degrees).

Normally Aspirated—When the air-fuel mix is inducted into the engine solely by the lower pressure produced in the cylinder during the intake stroke; aspiration not aided by a supercharger.

Otto-Cycle Engine—See Four-Cycle Engine

Overlap or Valve Overlap—The period, measured in crank degrees, when both the exhaust valve and the intake valve are open. Valve overlap allows the negative pressure scavenge wave to return from the exhaust system and begin the inflow of air/fuel mixture into the cylinder even before the intake stroke begins. The effectiveness of the overlap period is dependent on engine speed and exhaust “tuning.”

RPM—Revolutions Per Minute. A unit of measure for angular speed. As applied to the IC engine, rpm indicates the instantaneous rotational speed of the crankshaft described as the number of crank revolutions that would occur every minute if that instantaneous speed was held constant throughout the measurement period. Typical idle speeds are 300 to 800rpm, while peak engine speeds can reach as high as 10,000rpm or higher in some racing engines.

Mini Glossary

Simulation and Engine Simulation—A engine simulation process or program attempts to predict real-world responses from specific component assemblies by applying fundamental physical laws to “duplicate” or simulate the processes taking place within the components.

Smallblock—A generic term that usually refers to a V8 engine with a displacement small enough to be contained within a “small” size engine block. Typical smallblock engines displace under 400 cubic inches.

Stroke—The maximum distance the piston travels from the top of the cylinder (at TDC) to the bottom of the cylinder (at BDC), measured in inches or millimeters. The stroke is determined by the design of the crankshaft (the length of the stroke arm).

Top Dead Center or TDC—The position of the piston in the cylinder bore at its uppermost point in the stroke. Occurs twice within the full cycle of a four-stroke engine; at the start of the intake stroke and 360 degrees later at the end of the compression stroke.

Torque—The static twisting force produced by an engine. Torque varies with the length of the “arm” over which the twisting force is measured. Torque is a force *times* the length of the measurement arm: $Torque = Force \times Torque\ Arm$, where *Force* is the applied or the generated force and *Torque Arm* is the length through which that force is applied. Typical torque values are ounce-inches, pound-feet, etc.

Valve Head and Valve Diameter—The large end of an intake or exhaust valve that determines the working diameter. Valve head temperature can exceed 1200 degrees(F) during engine operation and a great deal of that heat is transferred to the cylinderhead through the contact surface between the valve face and valve seat.

Valve Lift—The distance the valve head raises off of the valve seat as it is actuated through the valvetrain by the camshaft. Maximum valve lift is the greatest height the valve head moves off of the valve seat; it is the lift of the cam (lobe height minus base-circle diameter) multiplied by the rockerarm ratio (in engines equipped with rockerarms).

Valve Motion Curve or Valve Displacement Curve—The movement (or lift) of the valve relative to the position of the crankshaft. Different cam styles (i.e., flat, mushroom, or roller) typically have different displacement curve acceleration rates. Engine simulation programs calculate a valve motion curve from valve event timing, maximum valve lift, and other cam timing specifications.

Volumetric Efficiency—An engine measurement calculated by dividing the mass of air inducted into the cylinder between IVO and IVC by the mass of air that would fill the cylinder at atmospheric pressure (with the piston at BDC). Typical values range

Mini Glossary

from 0.6 to 1.2, or 60% to 120%. Peak torque always occurs at the engine speed that produced the highest volumetric efficiency.



**Motion Software, Inc.
222 South Raspberry Lane
Anaheim, CA 92808-2268**

**Support Phone: 714-231-3801
Support Fax: 714-947-5389
Web: www.MotionSoftware.com
Email: support@motionsoftware.com**